

Operating and installation instructions

Differential pressure monitor

RM-DPC Micro FP SensorLine

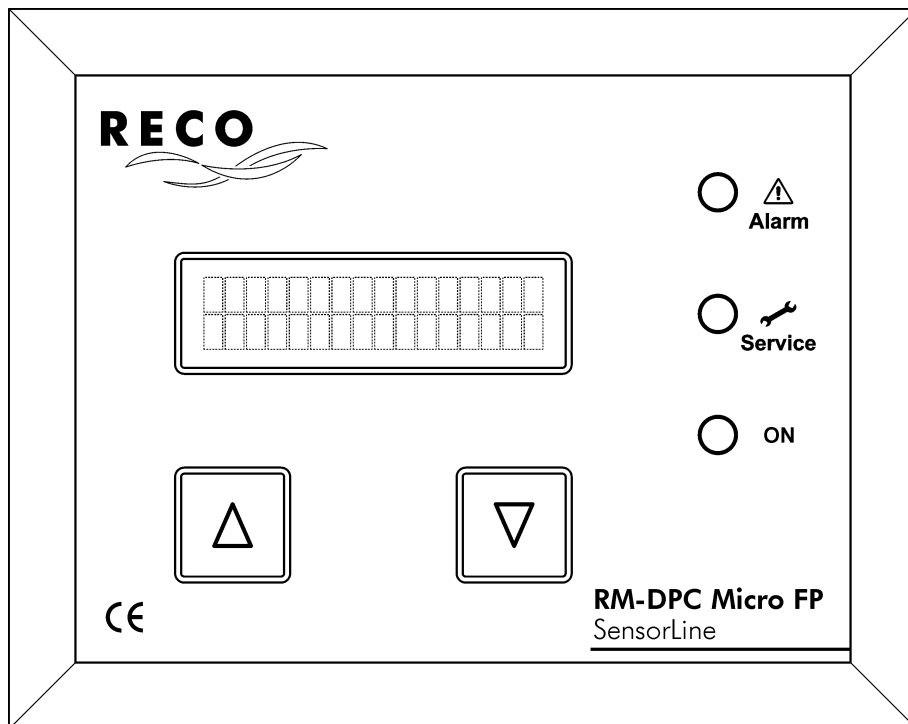



Table of contents

1 Safety instructions.....	3
2 Equipment specification	3
3 Assembly.....	4
4 Step-by-step installation	4
5 Step-by-step settings.....	6
5.1 Function in delivery status	6
5.2 Display and setting elements.....	6
5.3 Setting parameters	8
5.4 Parameter list	9
6 Details on device function	10
6.1 Two-position controller (Parameters 01, 02, 03, 04, 05).....	10
6.2 Differential pressure monitor (Parameters 01, 04, 05).....	11
6.3 Timer function (Parameters 06, 07, 08).....	12
6.4 Self-monitoring	12
7 Troubleshooting	12
8 Text messages on the display.....	13
8.1 Operating messages.....	13
8.2 Additional information	13
8.3 Alarm messages.....	13
9 Glossary	14
10 Technical specifications	15

Regulations

VDE 0160	EN 60.439 Part 500
EN 50178	2006/95 EC

Legend

-  Important note
-  Important warning

1 Safety instructions

When connected to the mains, the RM-DPC Micro FP differential pressure monitor is live and poses an electrical hazard. Device failure, serious or even fatal injuries may occur as a result of improper installation of the connected equipment. In addition to the general safety regulations for equipment in industrial electrical installations therefore, pay particular attention to the following points:

- The device may only be installed by qualified experts, in accordance with the provisions of IEC 364, DIN VDE 0105 for electrical equipment.
- All applicable laws, conditions, rules and regulations governing the setting up of electrical equipment must be observed in respect of the installation site.
- Equipment with protection rating IP00 without covers may only be configured by authorised expert staff when disconnected and whilst observing the local safety and accident prevention regulations.

The RM-DPC Micro FP may only be operated in the permitted operating area.



Switch off the mains supply before replacing the differential pressure monitor or any components connected to it. Otherwise the equipment may be damaged.

2 Equipment specification

The devices in the SensorLine RM-DPC Micro FP series are differential pressure controllers designed for use in robust, industrial environments. They are used for measuring, visualising and controlling non-aggressive, gaseous media in the excess pressure and insufficient pressure ranges.

All necessary functions can be configured and displayed simply using a text display with two-key menu control. In operating mode, the text display shows the differential pressure in variable physical sizes. The status messages ON / SERVICE / ALARM are also indicated by LEDs.

In addition to the controller functions for differential pressure, the software can also be used to allocate a two-position controller (Δp controller), a differential pressure monitor and a time function. The full scale output for the measured differential pressure can be set by the parameter 12 "dP range". The analog output signal is automatically adjusted to the set full scale output.

3 Assembly

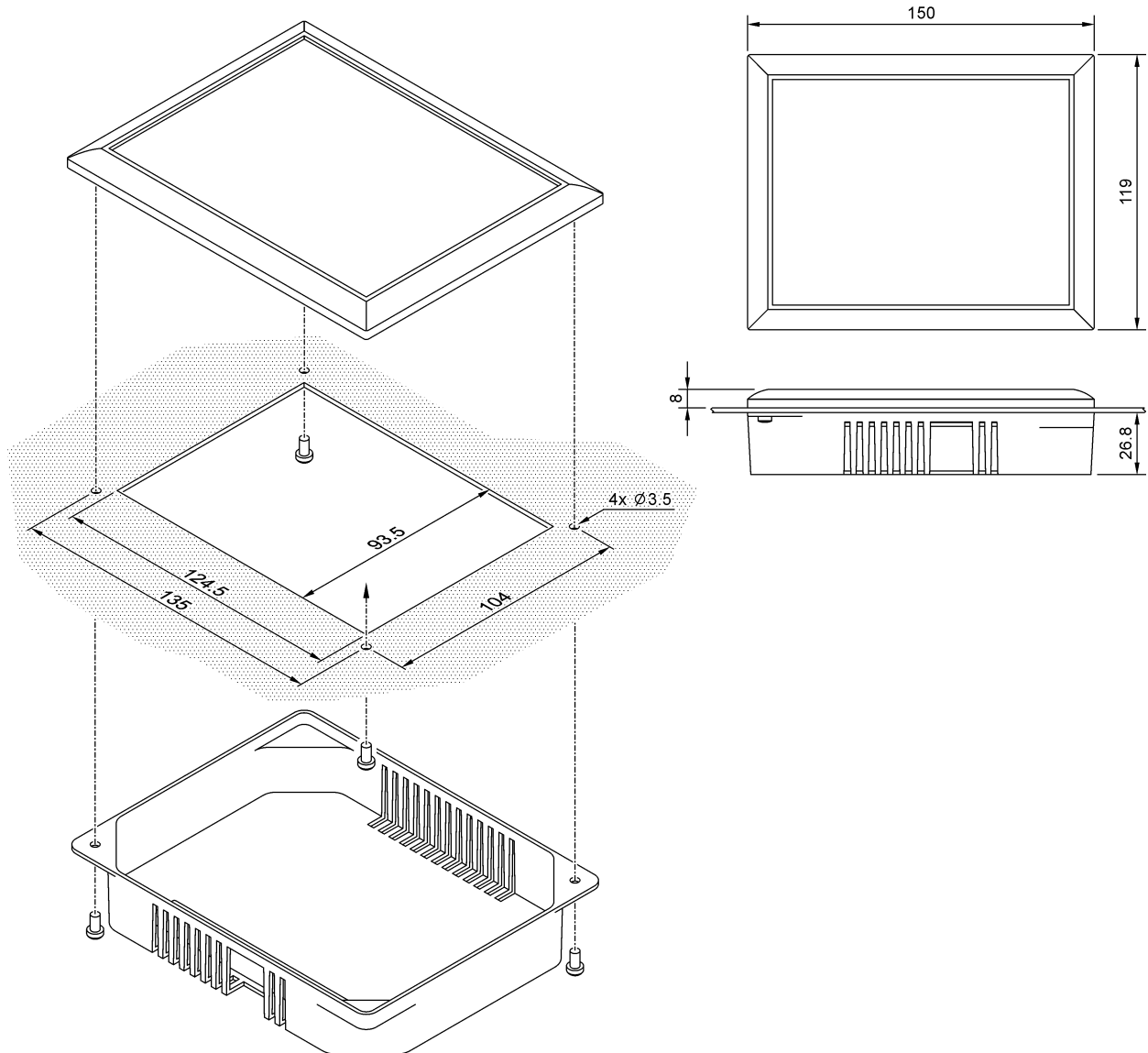

4 Step-by-step installation

1 Connecting the supply voltage

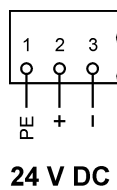

2 More connections

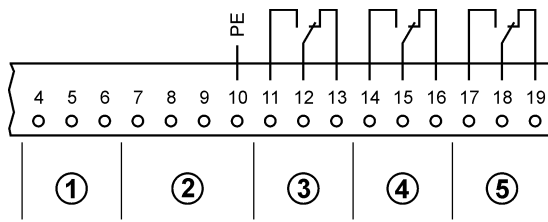

- ① Outputs 2-10V (0-10V*) / 4-20mA (0-20mA*)
 2-10 V (0-10 V*) : Terminals 4 (+) and 5 (-)
 4-20 mA (0-20 mA*) : Terminals 5 (-) and 6 (+)
- ② Inputs 4-20 mA "external sensor"
 passive: Terminals 7 (+24V), 8 (+) and 10 (PE)
 active: Terminals 8 (+), 9 (-) and 10 (PE)
- ③ Relay output "Δp controller"
- ④ Relay output "Δp min alarm"
- ⑤ Relay output "Δp max alarm"

* If parameter 13 "Current range" is set on the range 0-20 mA.

i

Signal cables may not be run parallel to power cables.

Tighten all cable glands in use to ensure that the cables are properly enclosed and that protection rating IP-66 is guaranteed.

Cable glands that are not in use must be closed or replaced with blank plugs.

3 Connection for differential pressure measurement lines

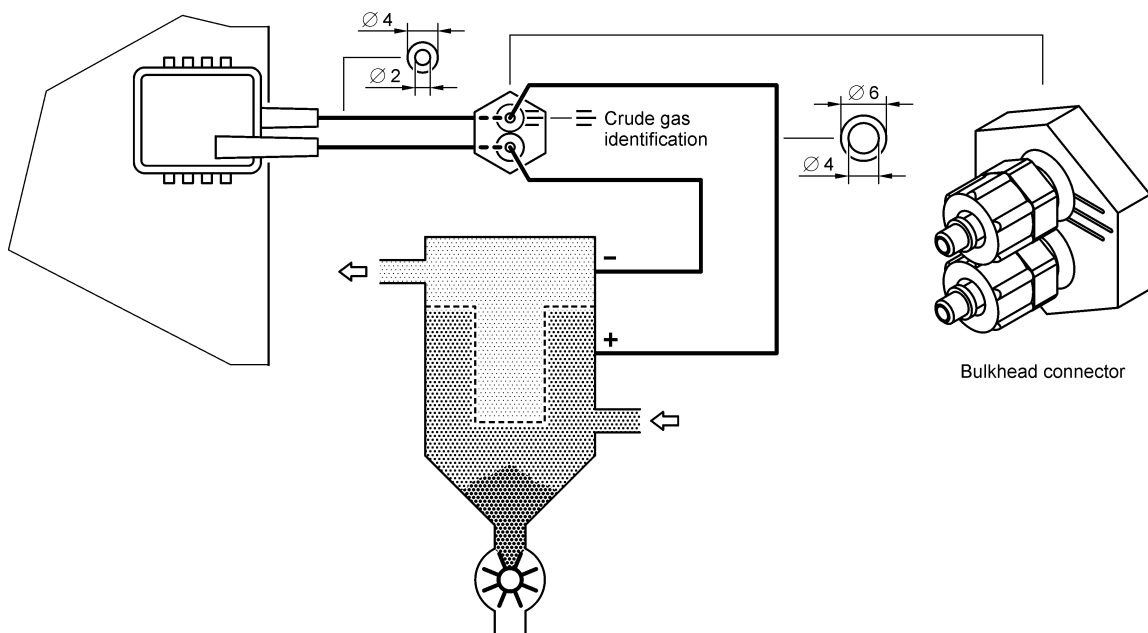

5 Step-by-step settings

5.1 Function in delivery status

The functions of a differential pressure dependent two-position controller and a differential pressure monitor are active on delivery.

Two-position controller: If the increasing differential pressure exceeds the Δp max switch point (factory setting: 900 Pa), relay contact 12, 13 closes and contact 11, 12 opens (see point ③ on page 5). If the decreasing differential pressure falls below the Δp min switch point (factory setting: 700 Pa), relay contact 12, 13 opens and contact 11, 12 closes.

Differential pressure monitoring: If the increasing differential pressure exceeds the Δp max alarm switch point (factory setting: 1800 Pa), relay contact 18, 19 closes and contact 17, 18 opens (see point ⑤ on page 5). If the differential pressure falls below the Δp max alarm switch point, relay contact 18, 19 opens and contact 17, 18 closes.

If another function is required or you want to activate additional functions, then you must change the parameter settings of the RM-DPC Micro FP. For more on this refer to points ⑨+⑩ "Configuration keys" on page 7 and section 5.3 "Setting parameters".

5.2 Display and setting elements

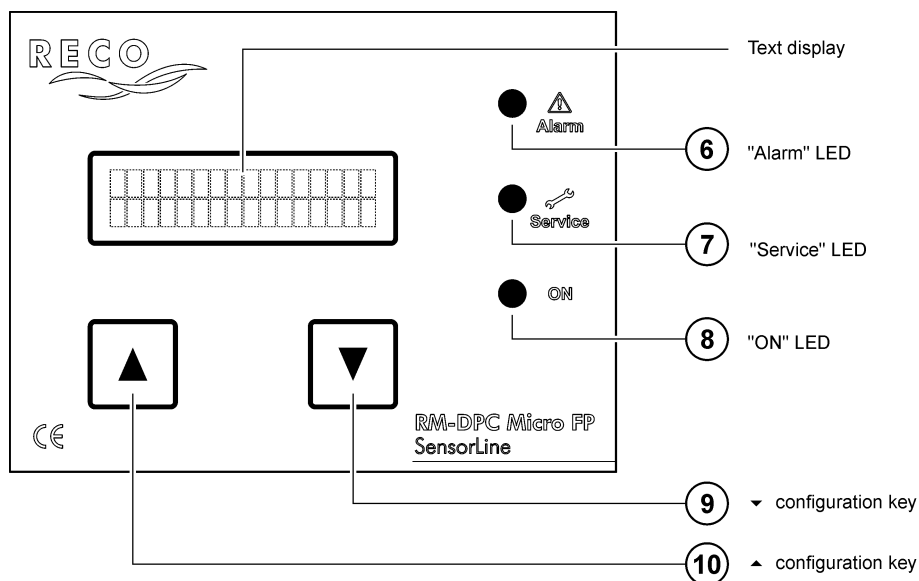

⑥ "Alarm" LED

This LED flashes if one of the following alarms is triggered:

- Δp min alarm
Differential pressure has fallen below the set Δp min alarm switch point (in the case of the Δp control device function) or has exceeded it (in the case of the Δp monitor device function).
- Δp max alarm (the set Δp max alarm switch point has been exceeded)

7 "Service" LED





This LED flashes if the set number of service hours has elapsed. This LED goes out when the service hours counter is reset to 0 hrs. In order to do this, Parameter 10 "Maintenance acknowledge ?" must be configured to "Yes".

8 "ON" LED







The "ON" LED is lit if supply voltage is present.

9 + 10 Configuration keys



- Selecting a parameter:

 +  Press and hold for more than 3 seconds. Then press  briefly to scroll up, or  to scroll down, until you see the required parameter in the display.

- Setting the parameter value:

Once you have selected a parameter, press  +  and hold for more than 3 seconds. Then press  briefly to scroll up, or  to scroll down, until you see the required parameter in the display. Then press  +  and hold for more than 3 seconds to save the configured value.

Then, if necessary, press

 briefly to scroll up, or  to scroll down,

and select additional parameters to configure or check.





- Returning to "Operation" mode:

 +  Press briefly.



The program automatically returns to "Operation" mode if no button is pressed in over one minute.

- Cancelling the parameter setting:

 +  Press briefly. Then press  +  again briefly to return to "Operation" mode.

5.3 Setting parameters

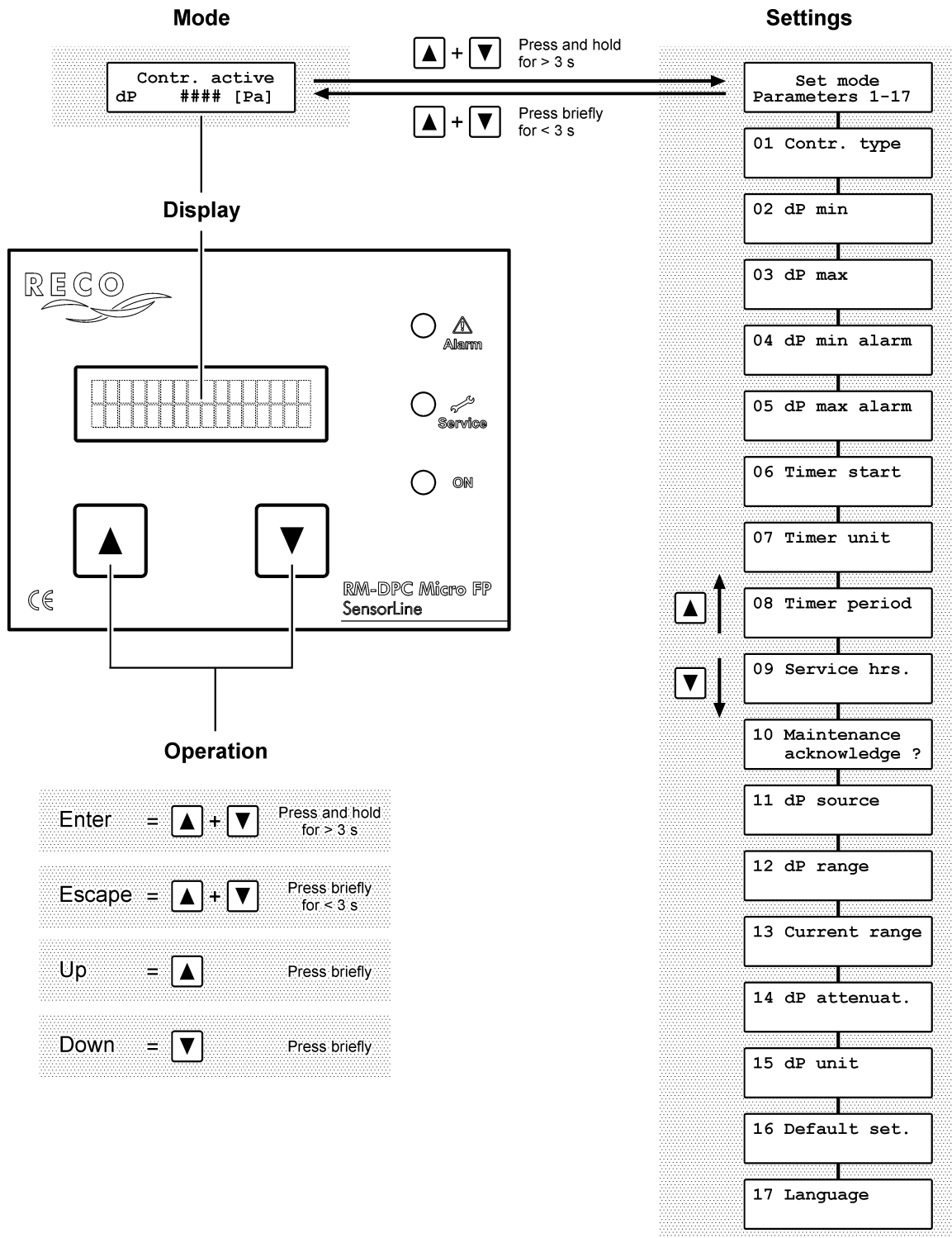

For more on this refer to points ⑨+⑩ "Configuration keys" on page 7

5.4 Parameter list

Parameter	Text on the display	Explanation	Factory setting	Setting range
01	01 Contr. type	Device function	dP-control.	dP-control, dP-monitor
02	02 dP min	Δp min switch point	700 Pa	150 Pa ... (dP max - 50 Pa) ¹
03	03 dP max	Δp max switch point	900 Pa	200 Pa ... (dP max alarm - 50 Pa) ²
04	04 dP min alarm	Δp min alarm switch point	0 ³	0 ³ , 100 Pa ... (dP max alarm - 50 Pa) ²
05	05 dP max alarm	Δp max alarm switch point	1800 Pa	0 ³ , 500 ... dP range ⁴
06	06 Timer start	Timer for relay output ⁵	0 ³	0 ³ ... 240 h
07	07 Timer unit	Time unit of the timer	min	s, min
08	08 Timer period	Time period of the timer	10 s	0 ³ ... 500 (s / min) ⁶
09	09 Service hrs.	Service hours alarm ⁷	0 ³	0 ³ , 500 hrs ... 25,000 hrs
10	10 Maintenance acknowledge ?	Resets the service hours counter	No	No, yes
11	11 dP source	Internal / External sensor	Internal	Internal, external
12	12 dP range	Full scale output	5000 Pa ⁸ or 10000 Pa ⁹	1000 Pa ... 5000 Pa ⁸ or 1000 Pa ... 10000 Pa ⁹
13	13 Current range	4-20 mA / 0-20 mA	4-20 mA	4-20 mA, 0-20 mA
14	14 dP attenuat.	Alarm / Control delay	2 s	1 s ... 30 s
15	15 dP unit	Unit of the displayed differential pressure	Pa	Pa, mbar, hPa, inch H ₂ O
16	16 Default set.	Loads factory setting	No	No, yes
17	17 Language	Display text language	DE	DE, EN, FR, ES

¹ Maximum value of the setting range = configured Δp max switch point (see Parameter 03 "dP max") minus 50 Pa.

² Maximum value of the setting range = configured Δp max switch point (see Parameter 05 "dP max alarm") minus 50 Pa.

³ 0 = Function deactivated.

⁴ Configured measuring range of the sensor (see Parameter 12 "dP range")

⁵ See point ③ on page 5

⁶ Depends on the setting of Parameter 07 "Timer unit".

⁷ The service hours counter runs when the differential pressure Δp is greater than 200 Pa and the parameter 09 "Service hrs." has not been configured to 0.

⁸ Applies to the RM-DPC 5000 Micro FP – the full scale output can be configured in 500 Pa increments.

⁹ Applies to the RM-DPC 10000 Micro FP – the full scale output is configurable in 500 Pa increments for the range 1000 Pa ... 5000 Pa, and continuously configurable for the range 5000 Pa ... 10000 Pa.

6 Details on device function

6.1 Two-position controller (Parameters 01, 02, 03, 04, 05)

In order to implement a differential pressure dependent two-point controller with the switch points Δp min and Δp max, Parameter 01 "Contr. type" must be configured to "dP control.". (For more on this refer to points ⑨+⑩ "Configuration keys" on page 7 and section 5.3 "Setting parameters".)

If the increasing differential pressure exceeds the configured Δp max switch point (Parameter 03), relay contact 12, 13 closes and contact 11, 12 opens (see diagram below). If the decreasing differential pressure falls below the configured Δp min switch point (Parameter 02), relay contact 12, 13 opens and contact 11, 12 closes.

It is also possible to configure a Δp max alarm switch point (Parameter 05) for rising differential pressure, and a Δp min alarm switch point (Parameter 04) for falling differential pressure. If the differential pressure exceeds the Δp max alarm switch point, relay contact 18, 19 closes and contact 17, 18 opens (see diagram below). If the differential pressure falls below the Δp min alarm switch point, relay contact 15, 16 closes and contact 14, 15 opens.

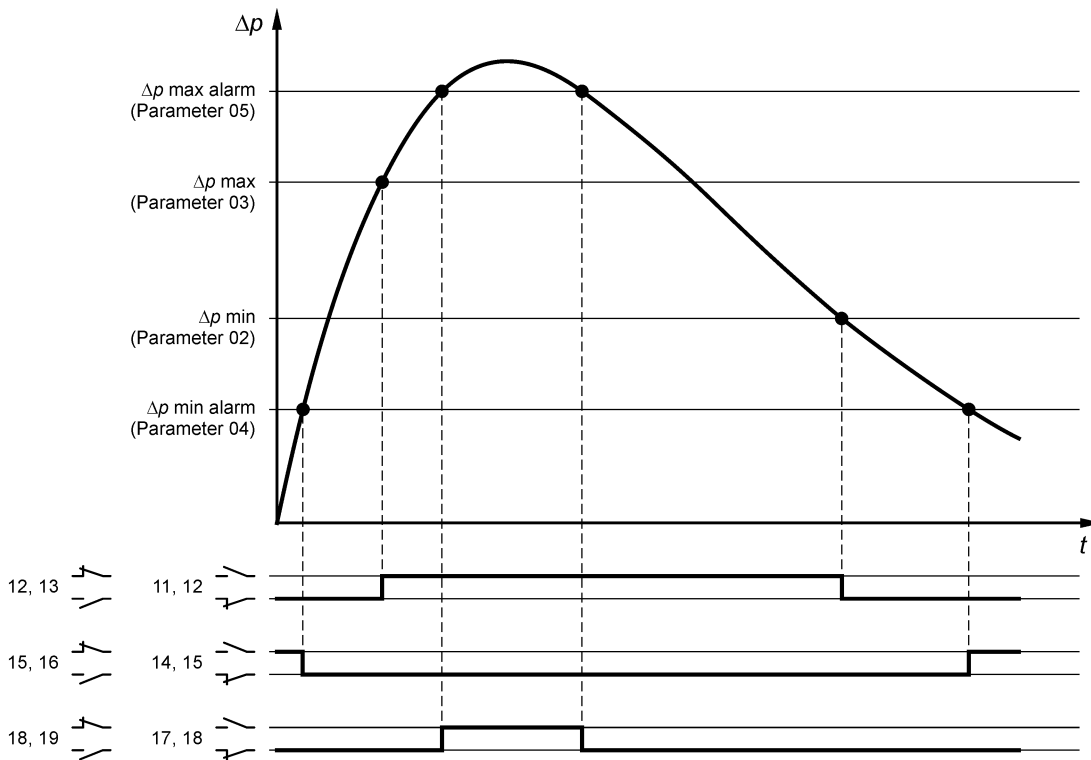

The setting Δp min alarm switch point (Parameter 04) = 0 deactivates the differential pressure monitoring function Δp min alarm.

The setting Δp max alarm switch point (Parameter 05) = 0 deactivates the differential pressure monitoring function Δp max alarm.

6.2 Differential pressure monitor (Parameters 01, 04, 05)

In order to implement a differential pressure monitor with the switch points Δp min alarm (for a Δp pre-alarm) and Δp max alarm, Parameter 01 "Contr. type" must be configured to "dP monitor". (For more on this refer to points ⑨+⑩ "Configuration keys" on page 7 and section 5.3 "Setting parameters".)

Δp pre-alarm: If the increasing differential pressure exceeds the configured Δp min alarm switch point (Parameter 04), relay contact 15, 16 closes and contact 14, 15 opens (see diagram below). If the differential pressure falls below the Δp min alarm switch point, relay contact 15, 16 opens and contact 14, 15 closes.

Δp max alarm: If the increasing differential pressure exceeds the configured Δp max alarm switch point (Parameter 05), relay contact 18, 19 closes and contact 17, 18 opens (see diagram below). At the same time, relay contact 15, 16 opens and contact 14, 15 closes. If the differential pressure falls below the Δp max alarm switch point, relay contact 18, 19 opens and contact 17, 18 closes.

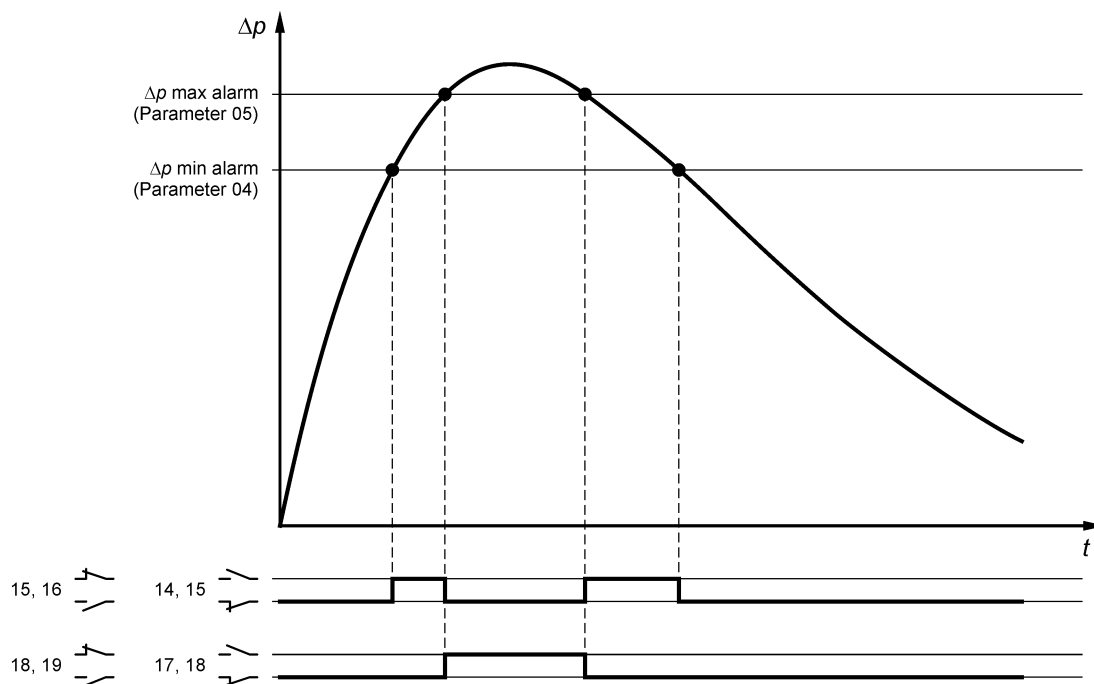

i The setting Δp min alarm switch point (Parameter 04) = 0 deactivates the differential pressure monitoring function Δp min alarm.

The setting Δp max alarm switch point (Parameter 05) = 0 deactivates the differential pressure monitoring function Δp max alarm.

6.3 Timer function (Parameters 06, 07, 08)

In addition to the differential pressure dependent two-position control, the timer function also makes it possible to carry out time-controlled forced cleaning. The timer works independently of other device functions.

After the time configured under "Timer start" (Parameter 06) elapses, relay contact 12, 13 closes and contact 11, 12 opens (see point ③ on page 5). After the time configured under "Timer period" (Parameter 08) elapses with the configured "Timer unit" (Parameter 07), relay contact 12, 13 opens and contact 11, 12 closes.

6.4 Self-monitoring

If all relay outputs are inactive (contacts 12, 13 / 15, 16 / 18, 19 are closed), then the RM-DPC Micro FP differential pressure monitor is either

switched off or

defective.

7 Troubleshooting



Error	Possible causes	Recommended action
The "ON" LED is not lit.	No mains voltage	Check power feed
	Device fuse is defective	Replace fuse
	EMERGENCY STOP activated	Check EMERGENCY STOP
No differential pressure display	Differential pressure measurement hoses are incorrectly attached.	Reattach the hoses to the connecting piece of the RM-DPC Micro FP.
Differential pressure display error	Hose connection error	<ul style="list-style-type: none"> ▪ Drain hoses. Clean joints between hose connections and the filter casing with compressed air (only towards the filter, never towards the sensor). ▪ Fit the hoses so there are no kinks. ▪ Check the hose connections in the device for water, kinks, etc.
"Alarm" LED flashing	Δp alarm	Refer to the service instructions of the filter.
"Service" LED flashing	The configured number of service hours has elapsed.	Perform filter maintenance. Then configure Parameter 10 to "Yes" (acknowledge the service message).

8 Text messages on the display

8.1 Operating messages

Display	Explanation
RM-DPC Micro Software #.#	Appears after the power is switched on and remains for approx. 1 second. The RM-DPC Micro FP can start up and perform a self-test during this time.
Contr. active dP ##### [Pa]	Display on device function "dP control." ##### currently measured differential pressure
Monitor active dP ##### [Pa]	Display on device function "dP monitor" ##### currently measured differential pressure

8.2 Additional information

i You can open the following additional information by pressing  or  in "Operation" mode, as long as there are no active alarm messages.



Display	Explanation
Operating hrs ##### [h]	Display of elapsed operating hours (#####) for 3 seconds. After 3 seconds, the display returns to the operating messages.
Time to service ##### [h]	Number of hours to next maintenance (#####), if the service hours counter has been activated. After 3 seconds, the display returns to the operating messages.
Time to timer #### [min]	Number of minutes to timer function (####), if the timer has been activated.

8.3 Alarm messages

Display	Explanation
dP min alarm dP ##### [Pa]	The Δp min alarm switch point has been exceeded. ##### currently measured differential pressure
dP max alarm dP ##### [Pa]	The Δp max alarm switch point has been exceeded. ##### currently measured differential pressure

i The Δp max alarm has priority over the Δp min alarm.
The Δp max alarm and the Δp min alarm messages are not saved. They are automatically deleted when the differential pressure falls below the relevant switch points.

9 Glossary

Term	Explanation
Bulkhead connectors	Connections for attaching the differential pressure measurement hoses.
Configuration	Parameter settings
Differential pressure monitor	Device function that monitors two configurable Δp switch points.
Differential pressure Δp	Difference between the pressure on the clean gas side and the pressure on the crude gas side of the filter.
Forced cleaning	Forced cleaning cycle, independent of the current status of the control sequence.
Service hours	The filter maintenance interval in hours configured under Parameter 09 "Service hrs."
Service hours counter	Internal hour counter that must be reset to 0 hrs after each filter service (see Parameter 10)
Time function	Relay contact 11, 12, 13 switches after the configured time elapses for the configured period of time.
Timer	See time function
Two-key menu control	The menu for parameter configuration can be operated with the two keys  and  .
Two-position controller	Controller with two switch points (here: Δp max and Δp min)
Δp controller	Device function for implementing differential pressure dependent cleaning
Δp max alarm switch point	Differential pressure value, which when exceeded causes the message "dP max alarm" to appear and relay contact 17, 18, 19 to switch.
Δp max switch point (also abbreviated as Δp max)	Upper switch point of the two-position controller, which when reached causes relay contact 11, 12, 13 to switch thus starting differential pressure dependent cleaning.
Δp min alarm switch point	In the case of device function Δp controller: Differential pressure value, which when decreasing (falling differential pressure) causes the message "dP min alarm" to appear and relay contact 14, 15, 16 to switch. In the case of device function Δp monitor: Differential pressure value, which when exceeded (rising differential pressure) causes the message "dP min alarm" to appear and relay contact 14, 15, 16 to switch.
Δp min switch point (also abbreviated as Δp min)	Lower switch point of the two-position controller, which when reached causes relay contact 11, 12, 13 to switch thus stopping differential pressure dependent cleaning.
Δp remote display	Display that shows the differential pressure of the filter in a switch room.

10 Technical specifications

	RM-DPC 5000 Micro FP	RM-DPC 10000 Micro FP
ΔP measuring range	Full scale output configurable from 1000 Pa ... 5000 Pa in 500 Pa increments	For the range 1000 Pa ... 5000 Pa the full scale output is configurable in 500 Pa increments For the range 5000 Pa ... 10000 Pa the full scale output is continuously configurable.
Full scale output (FSO)	5000 Pa	10000 Pa
Measuring sensor	Piezoresistive, overpressure-proof up to 138 kPa	
Accuracy (linearity and hysteresis)	$\leq \pm 1\%$ FSO	
Supply voltage	24 V ... 30 V DC	
Power consumption	max. 5 W	
Signal input	4-20 mA to connect an external differential pressure sensor	
Signal outputs	Relay outputs (change-over contact), potential-free max. contact load: 250 V AC, 10 A 50 V DC, 1,5 A / 30 V DC, 10 A (ohmic load)	
	Output 4-20 mA / 0-20 mA 4-20 mA corresponding to 0 ... x Pa*; resistance ≤ 600 Ohm 0-20 mA corresponding to 0 ... x Pa*; resistance ≤ 600 Ohm	
	Output 2-10 V / 0-10 V 2-10 V corresponding to 0 ... x Pa* 0-10 V corresponding to 0 ... x Pa*	
Fuse	T 1 A, 250 V, 5 x 20 mm	
Temperature range	- 20°C to + 60°C	
Protection rating	IP-20	
Dimensions	See section 3 "Assembly"	
Weight	approx. 250 g	
Installation height	max. 3000 m above M.S.L.	

* set full scale output

Disclaimer

The contents of this documentation has been verified for correctness and completeness. Nevertheless, errors can not be excluded so that we cannot guarantee the correctness of this information. Subject to alterations at any time.