



ADLINK
TECHNOLOGY INC.

MXC-6400 Series

MXC-6401D/MXC-6402D/MXC-6403D
High Performance 6th Generation Intel® Core™
i7/i5/i3 Fanless Computer

User's Manual



Manual Rev.: 2.00

Revision Date: Dec.2, 2016

Part No: 50-1Z217-2000

Advance Technologies; Automate the World.

Revision History

Revision	Release Date	Description of Change(s)
2.00	12/2/2016	Initial release

Preface

Copyright 2016 ADLINK Technology, Inc.

This document contains proprietary information protected by copyright. All rights are reserved. No part of this manual may be reproduced by any mechanical, electronic, or other means in any form without prior written permission of the manufacturer.

Disclaimer

The information in this document is subject to change without prior notice in order to improve reliability, design, and function and does not represent a commitment on the part of the manufacturer.

In no event will the manufacturer be liable for direct, indirect, special, incidental, or consequential damages arising out of the use or inability to use the product or documentation, even if advised of the possibility of such damages.

Environmental Responsibility

ADLINK is committed to fulfill its social responsibility to global environmental preservation through compliance with the European Union's Restriction of Hazardous Substances (RoHS) directive and Waste Electrical and Electronic Equipment (WEEE) directive. Environmental protection is a top priority for ADLINK. We have enforced measures to ensure that our products, manufacturing processes, components, and raw materials have as little impact on the environment as possible. When products are at their end of life, our customers are encouraged to dispose of them in accordance with the product disposal and/or recovery programs prescribed by their nation or company.

Trademarks

Product names mentioned herein are used for identification purposes only and may be trademarks and/or registered trademarks of their respective companies.

Conventions

Take note of the following conventions used throughout this manual to make sure that users perform certain tasks and instructions properly.



NOTE:

Additional information, aids, and tips that help users perform tasks.



Information to prevent **minor** physical injury, component damage, data loss, and/or program corruption when trying to complete a task.



Information to prevent **serious** physical injury, component damage, data loss, and/or program corruption when trying to complete a specific task.

Table of Contents

Revision History	ii
Preface	iii
List of Tables	xi
List of Figures	xiii
1 Introduction	1
1.1 Overview.....	1
1.2 Features.....	2
1.3 Specifications.....	3
Model Information	3
General Spec	3
1.4 Schematics and Dimensions	7
1.5 I/O Connectors.....	10
1.5.1 Power Button	11
1.5.2 LED Indicators	12
1.5.3 Reset Button.....	12
1.5.4 Digital I/O Connector	12
General Specification	13
Isolated Digital Input Circuits	15
Isolated Digital Output Circuits	18
Digital I/O Windows Driver and API	18
1.5.5 USB 3.0 Ports.....	19
1.5.6 Gigabit Ethernet Ports	19
1.5.7 CFast Socket.....	21
1.5.8 DVI-I Connector.....	21
1.5.9 COM Port Connectors	22
1.5.10 DisplayPort Connectors	23
Display Options	24

1.5.11	Audio Jacks	24
1.5.12	Keyboard & Mouse PS/2 Connectors	25
1.5.13	DC Power Connector.....	25
1.5.14	PCI Slot	26
1.5.15	PCI Express x8 Slot.....	26
1.5.16	PCI Express x16 Slot.....	27
1.5.17	Reserved Space for Wide PCI Express x16 Card	27
1.5.18	HDD Fast Plug Slot.....	27
1.6	Internal I/O Connectors.....	28
1.6.1	Mainboard Connectors	28
1.6.2	Backplane Connectors.....	30
1.6.3	DI/O & Daughter Board Connectors	31
1.6.4	SATA Board Connectors	32
1.6.5	Clear CMOS Jumper	32
1.6.6	Internal Reserved +5V and +12V Connector.....	33
1.6.7	Internal CFast Card Connector.....	33
1.6.8	12V DC Fan Connector	34
1.6.9	Internal USB Connector.....	34
1.6.10	SATA Connectors.....	34
1.6.11	USIM Port	34
2	Getting Started.....	35
2.1	Unpacking Checklist	35
2.2	Adaptors & Additional Accessories	35
2.3	Installing Hard Disk Drives.....	36
	Installing Internal HDDs	36
	Installing Swappable SATA HDDs	41
2.4	Installing a PCI/PCIe Card.....	43
2.5	Installing CFast Cards.....	46
2.6	Connecting and Using DisplayPort Extension Devices.....	48
2.7	Connecting DC Power	50
2.8	Wall-mounting the MXC-6400.....	50

2.9	Optional Fan Module	54
2.10	Cooling Considerations.....	55
2.11	Driver Installation	56
A	Appendix: Power Consumption.....	57
A.1	Power Consumption Reference.....	57
A.2	Power Supply Reference	58
A.3	Accessory Cabling	58
B	Appendix: BIOS Setup.....	59
B.1	Main	59
	BIOS Information	60
	Platform Information	60
	F/W Information	60
	System Time/System Date	61
B.2	Advanced.....	61
B.2.1	CPU Configuration.....	62
	Hyper-Threading	62
	Active Processor Cores	62
	Intel® Virtualization Technology	62
	CPU AES	63
	Intel® SpeedStep(tm)	63
	CPU C States	63
	Intel® TXT(LT) Support	63
	TCC Activation Offset	63
B.2.2	Memory Configuration	63
B.2.3	System Agent (SA) Configuration.....	64
	VT-d	64
B.2.4	Graphics Configuration.....	65
	Primary Display	65
	GTT Size	65
	Aperture Size	65

	DVMT Pre-Allocated	65
	DVMT Total Gfx Mem	66
B.2.5	Onboard Device Configuration	66
B.2.6	Advanced Power Management.....	68
B.2.7	USB Configuration	69
B.2.8	SATA Configuration	71
B.2.9	CSM Configuration	72
B.2.10	AMT Configuration.....	73
B.2.11	TPM 1.2 Configuration.....	74
B.2.12	Network Stack Configuration	75
B.2.13	NCT6106D HW Monitor.....	76
B.3	Security	77
B.4	Boot	78
B.5	Save & Exit	81
C	Appendix: Activating RAID Function	83
C.1	RAID Activation in System Management.....	84
C.1.1	Intel® Matrix Storage Manager.....	85
D	Appendix: Watchdog Timer (WDT)	
	Function Library	89
D.1	WDT with API/Windows	89
	InitWDT	89
	SetWDT	89
D.2	WDT with DOS/Linux.....	92
E	Appendix: Digital Input/Output	
	Function Library	95
	ADMX_DIO_Init	95
	ADMX_DIO_Close	95
	DI_ReadPort	96
	DO_WritePort	96
	DO_ReadPort	97

DI_ReadLine	97
DO_WriteLine	98
DO_ReadLine	99
DIO_INT_Event_Message	99
DIO_INT1_EventMessage	101
DIO_INT2_EventMessage	102
DIO_SetDualInterrupt	103
Important Safety Instructions	105
Getting Service.....	109

This page intentionally left blank.

List of Tables

Table 1-1:	Front Panel I/O Connector Legend.....	11
Table 1-2:	LED Indicators	12
Table 1-3:	Digital I/O Connector Pin Signals	14
Table 1-4:	Digital I/O Connector Pin Legend	15
Table 1-5:	Active/Link LED	20
Table 1-6:	Speed LED	20
Table 1-7:	DVI-I Connector Signals	22
Table 1-8:	D-Sub 9p Signal Function of COM Ports.....	22
Table 1-9:	DisplayPort Pin Assignments	23
Table 1-10:	Applicable Cable Types.....	23
Table 1-11:	Maximum Available Resolutions with 3-Display Configuration.....	24
Table 1-12:	Audio Jack Signals	24
Table 1-13:	PS/2 Connector Signals	25
Table 1-14:	DC Power Supply Connector Signals.....	26
Table 1-15:	Mainboard PCB (Top) Connector Legend	28
Table 1-16:	Mainboard PCB (Underside) Legend	29
Table 1-17:	Backplane PCB (Top) Connector Legend	30
Table 1-18:	DI/O & Daughter Board (Top) Connector Legend	31
Table 1-19:	Backplane PCB (Top) Connector Legend	32
Table 1-20:	Clear CMOS Jumper Settings	32
Table 1-21:	+5V and +12V Connector Pin Functions	33
Table A-1:	Power Consumption	57
Table A-2:	Power Supply	58

This page intentionally left blank.

List of Figures

Figure 1-1:	MXC-6400 Functional Block Diagram	6
Figure 1-2:	MXC-6400 Left Side View	7
Figure 1-3:	MXC-6400 Top View	7
Figure 1-4:	MXC-6400 Front View	8
Figure 1-5:	MXC-6400 Underside View	9
Figure 1-6:	Front Panel I/O Connectors	10
Figure 1-7:	Isolated Digital Input Circuit.....	15
Figure 1-8:	Isolated Digital Input Differential Input Circuit.....	16
Figure 1-9:	Isolated Digital Input Sample Application Circuit	17
Figure 1-10:	Isolated Digital Output Circuits	18
Figure 1-11:	Isolated Digital Output Sample Application Circuit ...	18
Figure 1-12:	DisplayPort Connector.....	23
Figure 1-13:	Mainboard PCB (Top).....	28
Figure 1-14:	Mainboard PCB (Underside)	29
Figure 1-15:	Backplane PCB (Top)).....	30
Figure 1-16:	DI/O Board PCB (Top).....	31
Figure 1-17:	Daughter Board PCB (Underside).....	31
Figure 1-18:	SATA Board PCB (Top))	32
Figure 1-19:	+5V and +12V Connector	33

This page intentionally left blank.

1 Introduction

1.1 Overview

The Matrix MXC-6400 provides powerful, fanless, expandable embedded computing using the new 6th generation Intel® Core™ i7/i5/i3 processors with improved computing performance. The MXC-6400 continues the exceptional fanless and cable-free design from the existing Matrix C series.

The MXC-6400 offers 2x DisplayPort and 1xDVI-I ports supporting three independent displays, 6x USB3.0 ports, and 3 GbE LAN ports with teaming function. Two front-mounted hot-swappable SATA III ports support 2.5" storage with high speed 6.0 Gb/s SATA and two onboard SATA III internal ports support RAID 0, 1, 5, 10. Built-in 16 channel isolated DI/O enables general industrial control. PCI & PCI express (Gen3) expansion slots receive a variety of PCI, PCIe8, and PCIe16 add-on cards for specific application platform development operations.

Compared to other industrial PCs, the MXC-6400 is more compact and reliable with a fanless and cable-free design, with superior dependability in harsh environments where severe temperature variation and vibration may occur. The MXC-6400 provides an optional hot-pluggable fan module to dissipate heat from the system when high power consumption PCI/PCIe cards are installed. Innovative mechanical design retains a cable-free structure which dramatically improves thermal stability when PCI/PCIe cards are installed.

1.2 Features

- ▶ 6th Generation Intel® Core™ i7/i5/i3 processors and QM170 chipset
- ▶ 2 DDR4 SO-DIMM sockets support up to 32GB memory
- ▶ 1 PCI and 2 PCIe x8 or 1 PCI and 1 PCIe x16 slots, supporting PCIe Gen3 cards
- ▶ 2 Mini PCIe slots and 1 USIM slot
- ▶ Support for 3 independent displays with 2 DisplayPort and 1 DVI-I ports
- ▶ 6 USB 3.0 ports and internal USB 2.0 dongle
- ▶ 3 Intel® GbE LAN ports with teaming function, Intel® iAMT 11.0
- ▶ 2 software-programmable RS-232/ 422/485 and 2 RS-232 ports
- ▶ Two front-mounted hot-swappable SATA III ports support 2.5" storage with high speed 6.0 Gb/s SATA and two onboard SATA III internal ports support RAID 0, 1, 5, 10
- ▶ Built-in 9V DC to 32V DC wide-range DC power input
- ▶ Remote power on/off switch connector on front panel
- ▶ Rugged construction provides fanless -20°C to 70°C operability (w/ optional industrial SSD)
- ▶ Optional 16-CH isolation DI and DO with interrupt and configurable digital filter
- ▶ SEMA 3.0 management utility pre-installed



This option guarantees cold boot of the system at -20°C and operation with 100% loading at 70° without add-on cards. The industrial solid-state drive storage option is required.

1.3 Specifications

Model Information

MXC-6401D	MXC-6402D	MXC-6403D
Intel® Core™ i7-6820EQ 4 Core/8 Threads, 2.8GHz, 8M cache (Max turbo frequency 3.5GHz)	Intel® Core™ i5-6440EQ 4 Core/4 Threads, 2.7GHz, 6M cache (Max turbo frequency 3.4GHz)	Intel® Core™ i3-6100E 2 Core/4 Threads, 2.7GHz, 3M cache

General Spec

System	
Chipset	Intel® Mobile Platform Controller hub (QM170)
Video	2x DisplayPort 1.2 support VGA/DVI/HDMI interfaces via converter cable with latching VGA+DVI dual display output via DVI-I connector HD 4K resolution supporting 3 independent audio streams with video/audio Gen 9 graphics
Memory	2x SO-DIMM sockets supporting DDR4 2133 MHz up to 32GB
I/O Interface	
Expansion	1x PCI +2x PCIe8 slots or 1x PCI and 1x PCIe16 slots, auto switched
Mini PCIe	2x Mini PCIe slots
USIM	1x USIM slot for 3G
Ethernet	3x Intel® GbE ports (2 Intel® I210IT and I219 PHY) Teaming function support, Intel® iAMT 11.0, Wake On LAN
Serial Ports	2x software-programmable RS-232/422/485 (COM1 & COM2) with auto-flow control 2x RS-232 (COM3 & COM4)
USB	6x USB 3.0 ports (two 1600mA and four 900mA) 1x internal USB 2.0 port

DI/O (option)	16CH DI and 16CH DO with isolation COS interrupt for all digital input Configurable digital filter
Audio	Audio-in / Line-out
KB/MS	1 PS/2 keyboard and 1 PS/2 mouse
WDT	Watch Dog Timer supported
Power Supply	
DC Input	Built-in 9-32 VDC wide-range DC input 3P pluggable connectors with latch (GND, V-, V+) 3-pin remote power on/off switch on the front panel
AC Input	Optional 160W external AC-DC adapter for AC input
Storage	
SATA HDD	2x front-mounted hot-swappable SATA III ports 2x onboard SATA III internal ports support RAID 0, 1, 5, 10
Compact Flash	1 type II CFAST socket
Mechanical	
Fan Module	Optional hot-pluggable fan module for dissipating heat from PCI/PCIe card, smart fan control
Dimensions	150 (W) x 200 (H) x 225 (D) mm
Weight	4 kg
Mounting	Wall-mount kit
Environmental	
Operating Temperature	Standard: 0°C to 50°C (32°F to 122°F)(w/HDD) Extended Temperature option*: -20°C to 70°C (-4°F to 158°F) (w/industrial SSD or CFAST)
Storage Temperature	-40°C to 85°C (-40°F to 185°F) (excl. HDD/SDD/CFAST)
Humidity	approx. 95% @ 40°C (104°F) (non-condensing)
Vibration	Operating, 5 Grms, 5-500 Hz, 3 axes (w/ CFAST or SSD) Operating, 0.5 Grms, 5-500 Hz, 3 axes (w/ HDD)
ESD	Contact +/-4 KV and Air +/-8 KV

Shock	Operating, 50G, half sine 11ms duration (w/ CFAST or SSD)
EMC	CE and FCC Class A
Safety	UL/cUL, CB



NOTE:

Extending operating temperature to the -20°C to +60°C range is optional and requires an industrial solid-state storage drive.

Power Supply (24VDC)	Power Off*	System Idle**	System Full Load***	Recommended Power Supply****
Integrated Embedded Computer				
MXC-6401D i7	4.412W	25.02W	63.132W	160W
MXC-6402D i5	4.412W	24.03W	58.162W	160W
MXC-6403D i3	4.412W	23.85W	56.88W	160W

*In shutdown status with DC input and only PS2 keyboard/mouse connected

**Under Windows 7 desktop with no application programs executed

***Under Windows 7 with 100% CPU utilization and simultaneous access to all I/O devices

****Additional power supply is necessary if add-on cards are installed and in use

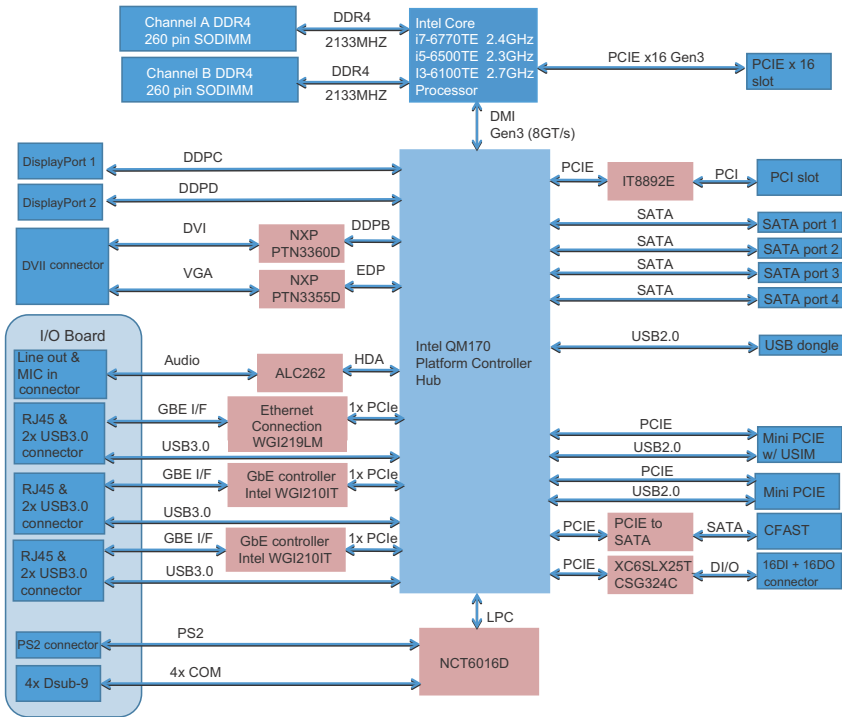

Figure 1-1: MXC-6400 Functional Block Diagram



NOTE:

All dimensions shown are in mm (millimeters).

1.4 Schematics and Dimensions

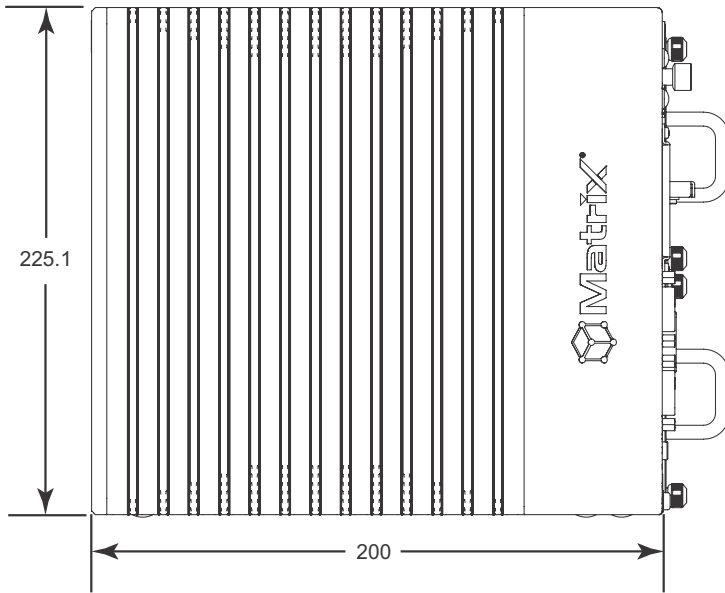

Figure 1-2: MXC-6400 Left Side View

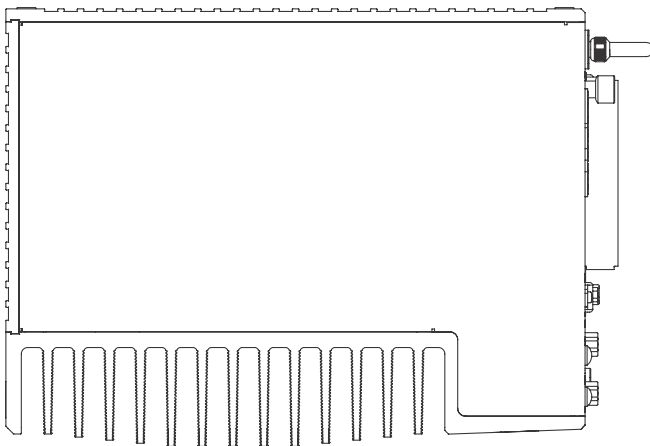

Figure 1-3: MXC-6400 Top View

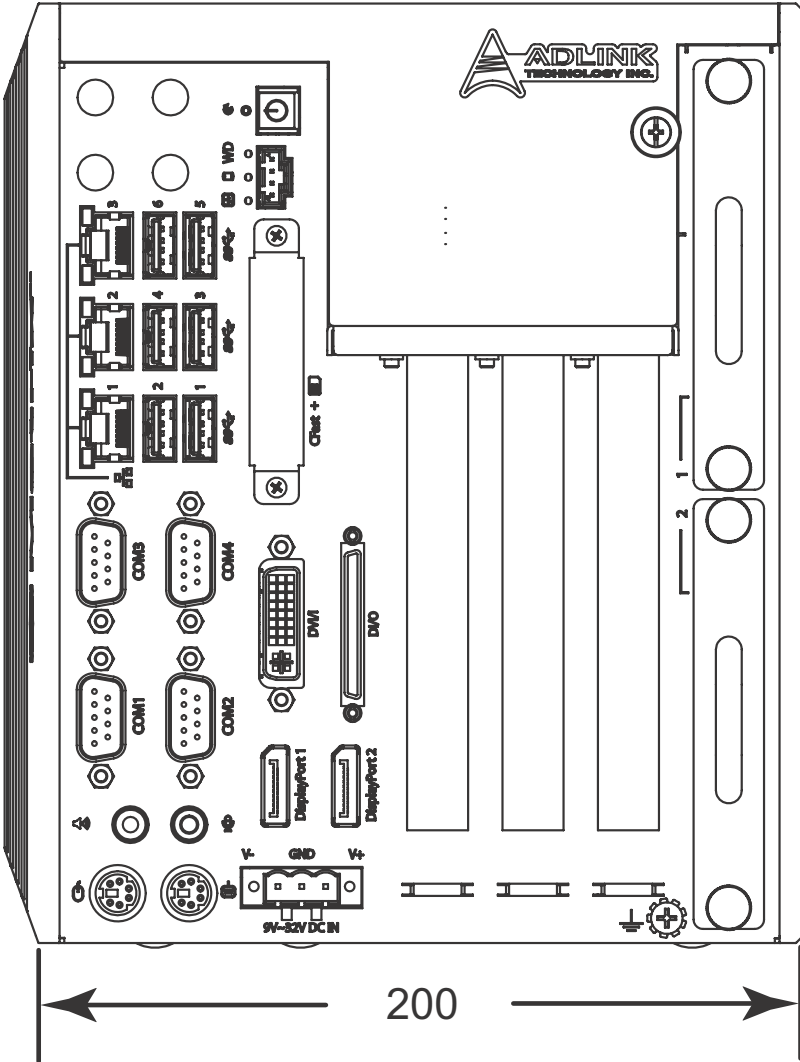

Figure 1-4: MXC-6400 Front View

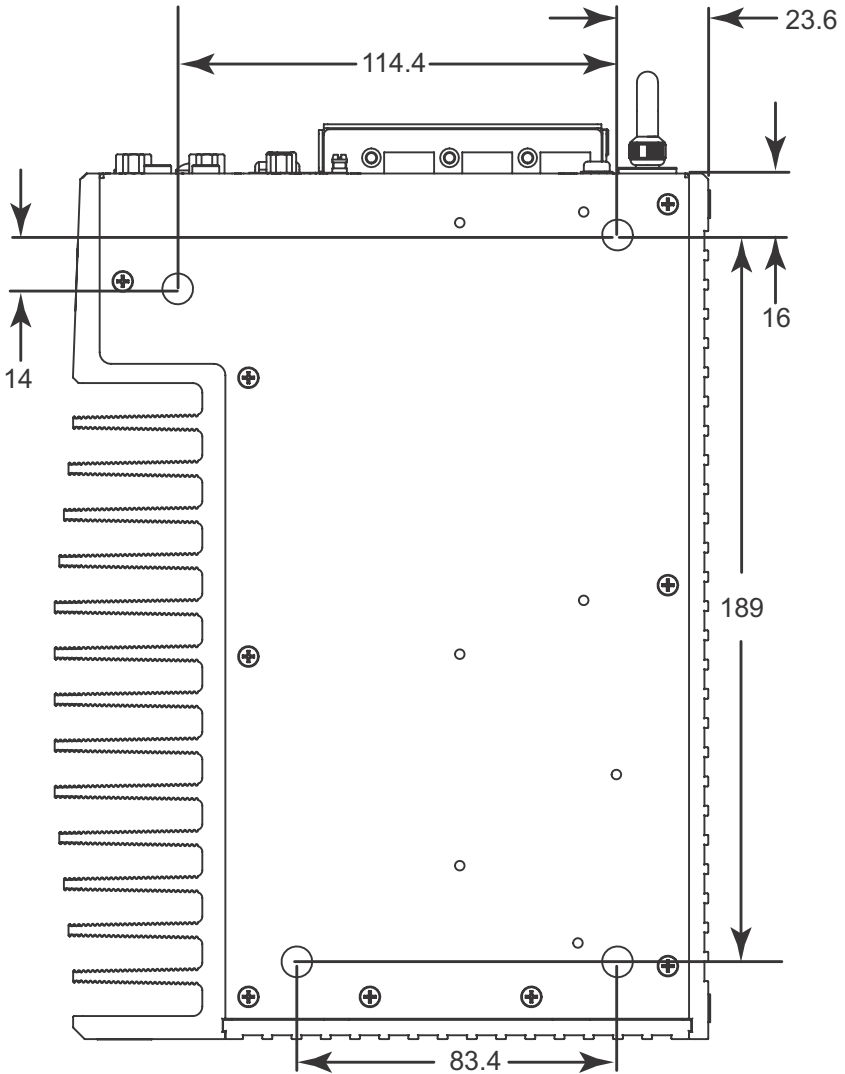

Figure 1-5: MXC-6400 Underside View

1.5 I/O Connectors

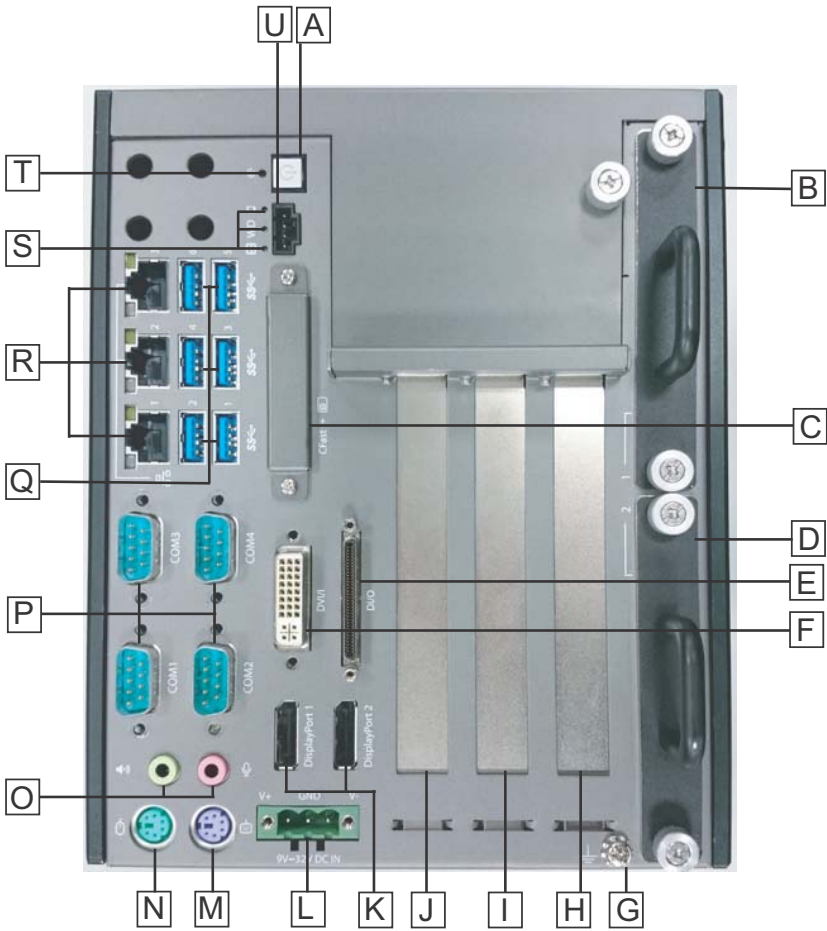

Figure 1-6: Front Panel I/O Connectors

A	Power	L	DC power supply
B	Swappable SATA	M	PS/2 keyboard

C	CFast (push-push, type II) + USIM card	N	PS/2 mouse
D	Swappable SATA	O	Audio
E	Digital I/O	P	4x COM
F	DVI-I	Q	6x USB3.0 (Type A)
G	Ground terminal	R	Gigabit Ethernet
H	PCI	S	LED indicators
I	PCIe x8	T	Reset
J	PCIe x16	U	Remote power/reset
K	DisplayPort		

Table 1-1: Front Panel I/O Connector Legend



NOTE:

1 PCIe x16 + 1 PCI expansion slot, with PCIe x16 signal converts to PCIe x8 if two PCIe x8 cards are installed in I and J slots

1.5.1 Power Button

The power button is a non-latched push button with a blue LED indicator. System is turned on when the button is depressed, and the power LED lights. If the system hangs, depress the button for 5 seconds to turn off the system completely.

1.5.2 LED Indicators

In addition to the LED of the power button, three LEDs on the front panel indicate the following.

LED indicator	Color	Description
Watchdog (WD)	Yellow	Indicates watchdog timer status. When watchdog timer starts, the LED flashes. When the timer is expired, the LED remains lit..
Hard disk drive (HD)	Orange	Indicates the HDD operating state. When the SATA hard drive or CFast card is active, the LED indicator flashes.
Diagnostic (DG)	Green	When lit continuously, indicates no physical storage is connected, and if blinking, indicates no memory is installed on either SODIMM socket.

Table 1-2: LED Indicators

1.5.3 Reset Button

The reset button executes a hard reset for the MXC-6400.

1.5.4 Digital I/O Connector

The MXC-6400 controller features an onboard isolated digital I/O circuit with a 68-pin VHDCI (Very High Density Cable Interconnect) connector on the front panel. The onboard digital I/O card supports the following features:

16CH Isolated DI

- ▶ Logic high: 5 to 24 V
- ▶ Logic low: 0 to 1.5 V
- ▶ Input resistance: 8.2K @ 0.75W
- ▶ Isolation type: photocoupler
- ▶ Isolation voltage: 1500 V DC

16CH Isolated DO

- ▶ Output Type: MOSFET transistor

- ▶ Sink current up to 100 mA (sustained loading) or 250 mA (peak loading) on each isolated output channel
- ▶ Supply voltage: 5 to 35 V DC
- ▶ Isolation type: Digital Isolator
- ▶ Isolation voltage: 1500 V DC
- ▶ Flywheel diode for VDD on all DO channels

Isolated 5V DC Power Source for DO

- ▶ Supply voltage: 5 ± 0.5 V DC
- ▶ Supply current: 180 mA (maximum)
- ▶ Isolation type: DC-to-DC transformer
- ▶ Isolation voltage: 1500 VRMS (channel to system)

General Specification

- ▶ 68-pin VHDCI (Very High Density Cable Interconnect) connector (mating with AMP 787082-7) on the front panel
- ▶ Optional accessories: DIN-68S-01 and ACL-10568-1
- ▶ Data transfer: programmed I/O
- ▶ Software Driver support for Win7 32bit: PCMe-1432_x86_v0.0.0.6
Software Driver support for Win7 64bit: PCMe-1432_x64_v0.0.0.7

	Pin	Signal	Pin	Signal	Pin	Signal
	1	+VDD	24	DI1_L	47	EOGND
	2	EOGND	25	DI0_H	48	DO10
	3	DO7	26	DI0_L	49	EOGND
	4	EOGND	27	DI11	50	DO9
	5	DO6	28	ISO_COM	51	EOGND
	6	EOGND	29	DI10	52	DO8
	7	DO5	30	ISO_COM	53	DI7_H
	8	EOGND	31	DI9	54	DI7_L
	9	DO4	32	ISO_COM	55	DI6_H
	10	EOGND	33	DI8	56	DI6_L
	11	DO3	34	ISO_COM	57	DI5_H
	12	EOGND	35	+VDD	58	DI5_L
	13	DO2	36	+V5DIO_CN_ISO	59	DI4_H
	14	EOGND	37	EOGND	60	DI4_L
	15	DO1	38	DO15	61	DI15
	16	EOGND	39	EOGND	62	ISO_COM
	17	DO0	40	DO14	63	DI14
	18	EOGND	41	EOGND	64	ISO_COM
	19	DI3_H	42	DO13	65	DI13
	20	DI3_L	43	EOGND	66	ISO_COM
	21	DI2_H	44	DO12	67	DI12
	22	DI2_L	45	EOGND	68	ISO_COM
	23	DI1_H	46	DO11		

Table 1-3: Digital I/O Connector Pin Signals

DI	DIn_H	High input of isolated differential DI channel (n=0 to 7)
	DIn_L	Low input of isolated differential DI channel (n=0 to 7)
	DIn	Input of isolated DI channel (n=8 to 15)
	ISO_COM	Common ground of isolated DI channel 8 to 15
DO	DO _n	Output of isolated DO channel (n=0 to 15)
	EOGND	Ground return path of isolated DO channel 0 to 15 and +V5DIO_CN_ISO
	+VDD	Power input signal for flywheel diode of isolated DO channel 0 to 15
	+V5DIO_CN_ISO	Isolated 5V DC power, maximum output 180mA

Table 1-4: Digital I/O Connector Pin Legend

Isolated Digital Input Circuits

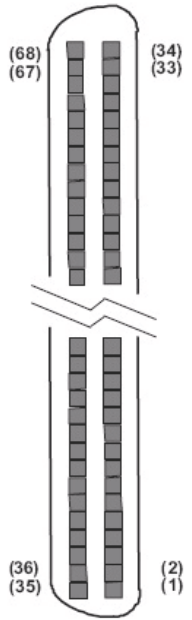
Input accepts voltages up to 24V, with input resistors of 8.2k Ω , with connections between outside signals as shown.

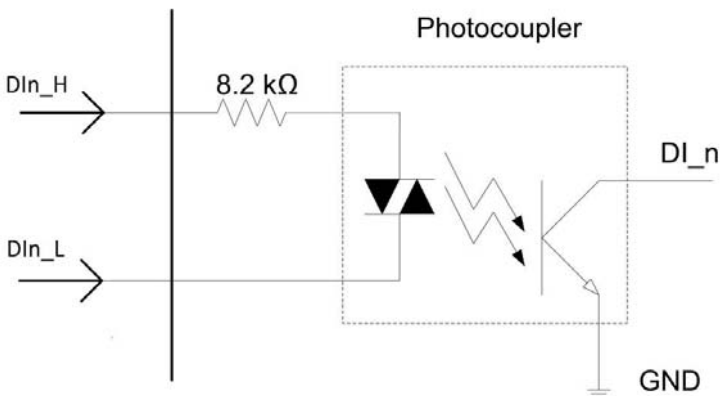

Figure 1-7: Isolated Digital Input Circuit

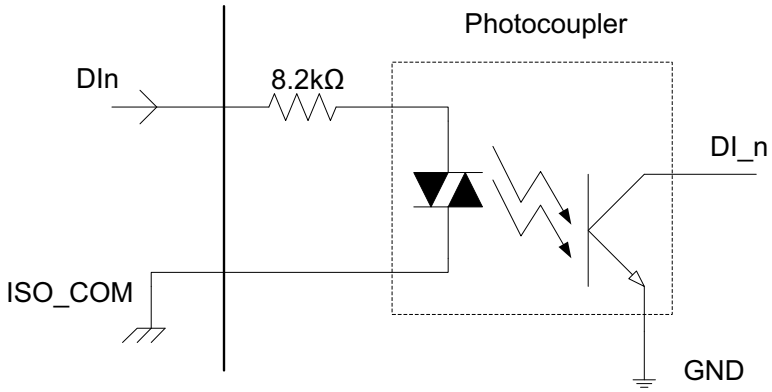

Figure 1-8: Isolated Digital Input Differential Input Circuit

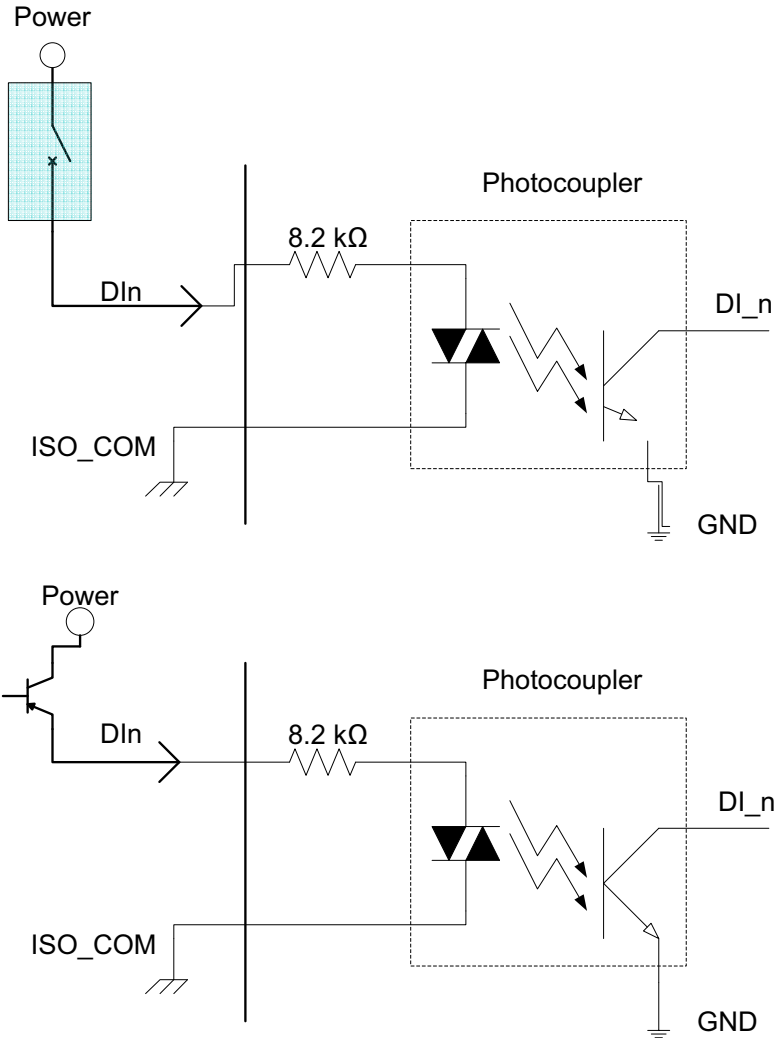

Figure 1-9: Isolated Digital Input Sample Application Circuit

Isolated Digital Output Circuits

Each isolation digital output channel adopts a MOSFET transistor, capable of driving peak current up to 250mA (sustained current up to 100 mA) with voltage ranges from 5V to 35V.

The VDD pin is connected in series with a flywheel diode protecting the driver during inductance loading, such as relay, motor, or solenoid, wherein the VDD must connect to external power to form a flywheel current loop.

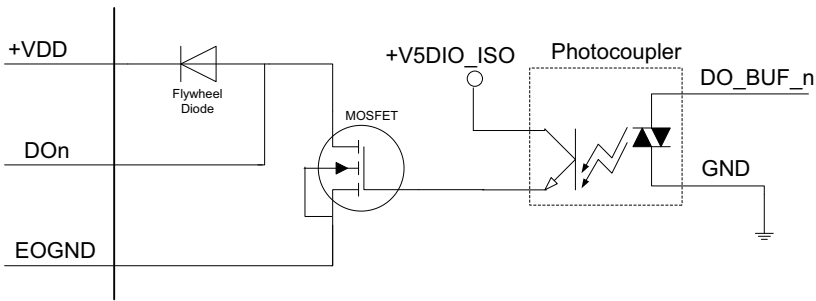

Figure 1-10: Isolated Digital Output Circuits

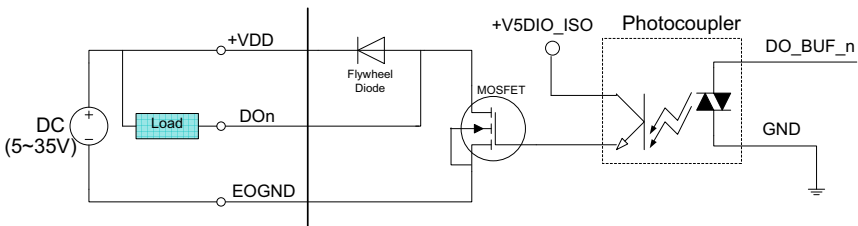

Figure 1-11: Isolated Digital Output Sample Application Circuit

Digital I/O Windows Driver and API

The MXC-6400 DI/O incorporates ADLINK's PCMe-1432 Windows driver, on the bundled driver CD or downloadable from Adlink's MXC-6400 web support page (driver for MXC-6400 DI/O).

1.5.5 USB 3.0 Ports

The MXC-6400 provides six USB 3.0 ports supporting Type A USB3.0 connection on the front panel. All USB3.0 ports are compatible with super-speed, high-speed, full-speed and low-speed USB devices.

1.5.6 Gigabit Ethernet Ports

The MXC-6400 has three Gigabit Ethernet ports on the front panel, supporting two Intel® WGI210IT GbE and Intel® I219LM Gigabit Ethernet PHY controllers.

WG210IT provides:

- ▶ IEEE 802.3az Energy Efficient Ethernet
- ▶ IEEE 1588/802.1AS precision time synchronization
- ▶ IEEE 802.3Qav traffic shaper
- ▶ Interrupt moderation, VLAN support, IP checksum offload
- ▶ PCIe OBFF (Optimized Buffer Flush/Fill) for improved system power management
- ▶ Four transmit and four receive queues
- ▶ RSS and MSI-X to lower CPU utilization in multi-core systems
- ▶ ECC - error correcting memory in packet buffers
- ▶ Wake-On-LAN
- ▶ NC-SI for increased bandwidth passthrough
- ▶ Preboot eXecution Environment (PXE) flash interface
- ▶ Jumbo frame support
- ▶ LAN Teaming

The Intel® I219LM provides:

- ▶ 802.3x flow control
- ▶ IEEE 802.1p and 802.1q
- ▶ Energy Efficient Ethernet(EEE)802.3az
- ▶ 10/100/1000 IEEE 802.3
- ▶ Automatic MDI/MDIX crossover at all speeds
- ▶ Wake-On-LAN
- ▶ Intel® AMT 11.0

- ▶ Reduced power consumption during normal operation and power down
- ▶ Preboot eXecution Environment (PXE) flash interface
- ▶ 9.5 kB jumbo frame support
- ▶ LAN teaming

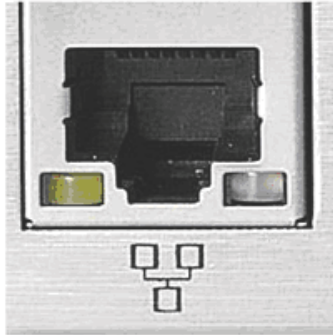

Active/Link Yellow	Speed LED Green/Orange
-----------------------	---------------------------

LED Color	Status	Description
Yellow	OFF	Ethernet port is disconnected.
	ON	Ethernet port is connected with no activity.
	Flashing	Ethernet port is connected and active.

Table 1-5: Active/Link LED

LED Color	Status	Description
Green/Orange	OFF	10 Mbps
	Green	100 Mbps
	Orange	1000 Mbps

Table 1-6: Speed LED

1.5.7 CFast Socket

The Matrix MXC-6400 is equipped with a Type II Push Push CFlash host connector on the front panel, by SATA interface. Data transfer rates up to 3.0Gb/s(300MB/s)/1.5Gb/s(150MB/s) are supported. The host SATA controller provides a legacy operating mode using I/O space, and an AHCI operating mode using memory space. The CFast card can function as a storage device for system installation.

1.5.8 DVI-I Connector

The MXC-6400 provides one DVI-I connector providing connection to an external monitor.



Since VGA signals are analog based, VGA display quality is greatly affected by quality and length of cable used. We strongly recommend VGA cable less than 2 meters in length with effective shielding, such as UL style 2919 AWM.

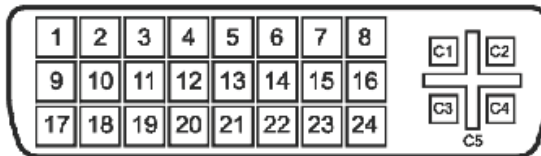

Pin	Signal	Pin	Signal	Pin	Signal	Pin	Signal
1	DVIdata 2-	9	DVIdata 1-	17	DVIdata 0-	C1	Analog Red
2	DVIdata 2+	10	DVIdata 1+	18	DVIdata 0+	C2	Analog Green
3	GND	11	GND	19	GND	C3	Analog Blue
4	CRT DDC clock	12	N/C	20	N/C	C4	Analog horiz. sync

Pin	Signal	Pin	Signal	Pin	Signal	Pin	Signal
5	CRT DDC data	13	N/C	21	N/C	C5	Analog GND
6	DVIDC clock	14	+5V	22	GND		
7	DVIDC data	15	GND	23	DVI clock +		
8	Analog vert. sync	16	Hot plug detect	24	DVI clock -		

Table 1-7: DVI-I Connector Signals

1.5.9 COM Port Connectors

The MXC-6400 provides four COM ports through D-sub 9 pin connectors. The COM1 & COM2 ports support RS-232/422/485 modes by BIOS setting, while COM3 and COM4 support only RS-232. Please refer to Section :CSM Support for details of BIOS COM port mode settings.

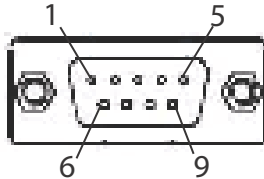

Pin	Signal Name		
	RS-232	RS-422	RS-485
1	DCD#	TXD422-	485DATA-
2	RXD	TXD422+	485DATA+
3	TXD	RXD422+	N/S
4	DTR#	RXD422-	N/S
5	GND	N/S	N/S
6	DSR#	N/S	N/S
7	RTS#	N/S	N/S
8	CTS#	N/S	N/S
9	RI#	N/S	N/S

Table 1-8: D-Sub 9p Signal Function of COM Ports

1.5.10 DisplayPort Connectors

Two displayport connectors on the front panel can connect to VGA, DVI, HDMI and DisplayPort monitors via DisplayPort to VGA adapter cable, DisplayPort to DVI adapter cable, or DisplayPort to HDMI adapter cable and DisplayPort cable.

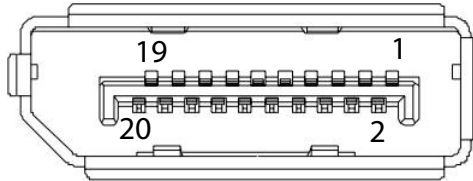

Figure 1-12: DisplayPort Connector

Pin	Signal	Pin	Signal
1	CN_DDPx0+	11	GND
2	GND	12	CN_DDPx3-
3	CN_DDPx0-	13	CN_DDPx_AUX_SEL
4	CN_DDPx1+	14	CN_DDPx_CONFIG2
5	GND	15	CN_DDPx_AUX+
6	CN_DDPx1-	16	GND
7	CN_DDPx2+	17	CN_DDPx_AUX-
8	GND	18	CN_DDPx_HPD
9	CN_DDPx2-	19	GND
10	CN_DDPx3+	20	+V3.3_DDPx_PWR_CN

Table 1-9: DisplayPort Pin Assignments

P/N	Description
30-01119-0000	Passive DisplayPort to HDMI adapter cable
30-01120-0000	Passive DisplayPort to DVI adapter cable
30-01121-0000	Passive DisplayPort to VGA adapter cable
30-01157-0000	Active DisplayPort to DVI adapter cable

Table 1-10: Applicable Cable Types

Display Options

With computing and graphic performance enhancement by its 3rd generation Intel® processor, the MXC-6400 controller can support three independent displays, with configuration as follows.

DisplayPort1	DisplayPort2	Other Ports
DisplayPort 4096x2304@60Hz	DisplayPort 4096x2304@60Hz	DVI 1920x1080@60Hz
DisplayPort 4096x2304@60Hz	DisplayPort 4096x2304@60Hz	VGA 1920x1200@60Hz

Table 1-11: Maximum Available Resolutions with 3-Display Configuration

1.5.11 Audio Jacks

The MXC-6400 implements Intel® High Definition audio on a Realtek ALC262 chip. The HD audio supports up to 24-bit, 192 KHz sample rate high quality headphone/lineout and microphone input. Audio jack access is on the front panel. The pink jack provides microphone input, and the green jack lineout.



Color	Signal
Green	lineout
Pink	Mic In

Table 1-12: Audio Jack Signals

1.5.12 Keyboard & Mouse PS/2 Connectors

The MXC-6400 provides PS/2 connectors for keyboard and mouse. The green connector provides PS/2 mouse connection and the purple connector PS/2 keyboard



Color	Signal
Green	Mouse
Purple	Keyboard

Table 1-13: PS/2 Connector Signals



NOTE:

Keyboard & mouse PS/2 connectors do not support hot-plug capability.

1.5.13 DC Power Connector

The DC power supply connector of the MXC-6400 is on the front panel. The power supply connector consists of three pins, V+, chassis ground, and V- from right to left respectively. V+ and V- pins provide DC power input and the chassis ground pin allows connection of the chassis to ground for better EMC compatibility.

The DC power input for the MXC-6400 allows a voltage input range from 9 V DC to 32 V DC.



Ensure that the DC power supply:

- ▶ is within the input voltage range defined in the specification
- ▶ is stable and low-noise DC
- ▶ provides sufficient operating current

DC power supply over or under voltage, unstable, or of insufficient power may cause system instability and physical damage

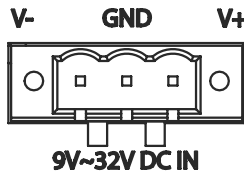

Pin	Signal
1	V+ (DC_IN)
2	GND (CHGND)
3	V- (DGND)

Table 1-14: DC Power Supply Connector Signals

1.5.14 PCI Slot

The MXC-6400 provides one PCI slot for expansion on the back-plane. Based on the ITE IT8892E PCIe to PCI bridge, connection to the host system is achieved through a PCIe x1 Gen2 interface, supporting universal or 5V PCI 32-bit cards operating at 33MHz clocks.

1.5.15 PCI Express x8 Slot

The MXC-6400 provides one PCI express x8 slot for expansion. The PCI express slot can support standard PCIe Gen 3 short cards.

1.5.16 PCI Express x16 Slot

One PCI express x16 slot supports expansion with standard PCIe Gen3 cards and full PCI express x16 signals if no card is present in the PCI express x8 slot. otherwise, the PCIe x16 slot is limited to PCIe x8 speeds.

1.5.17 Reserved Space for Wide PCI Express x16 Card

PCI express x16 cards equipped with cooling fans can require supplemental reserved space, this slot accommodates the fan.

1.5.18 HDD Fast Plug Slot

The Fast Plug host connector connecting to the host controller by SATA supports data transfer up to 3.0Gb/s (300MB/s)/1.5Gb/s (150MB/s).

1.6 Internal I/O Connectors

1.6.1 Mainboard Connectors

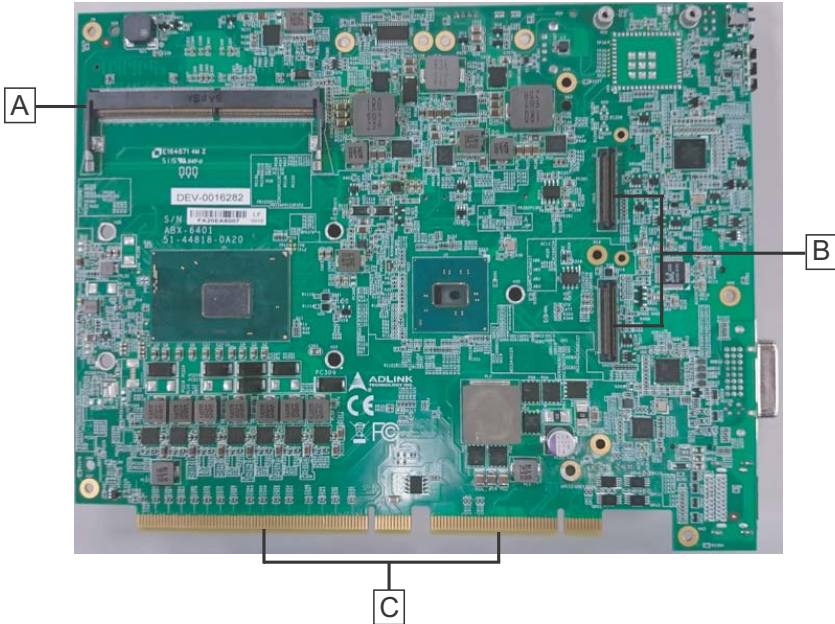

Figure 1-13: Mainboard PCB (Top)

A	SODIMM A socket
B	Board-to-board connectors (to daughter board)
C	Edge connector (to backplane)

Table 1-15: Mainboard PCB (Top) Connector Legend

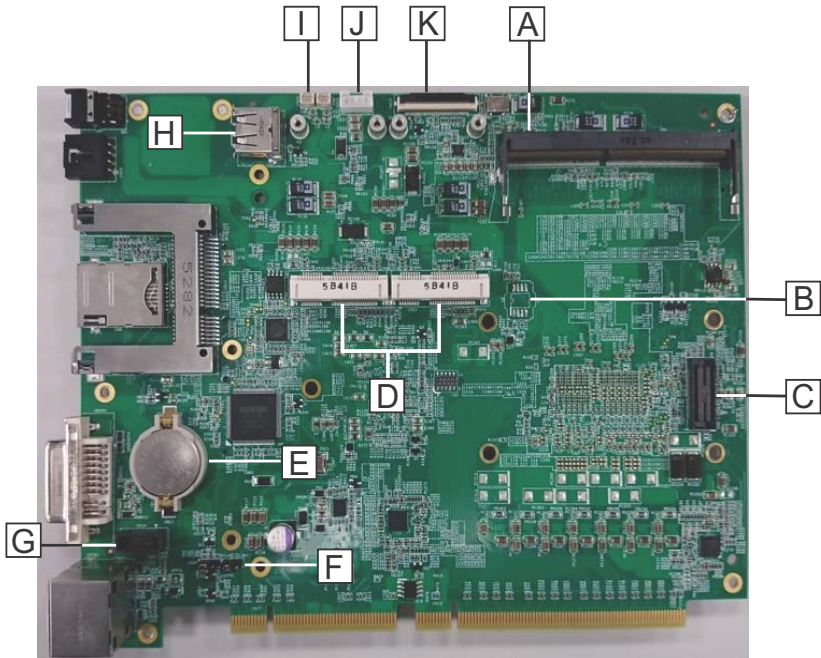

Figure 1-14: Mainboard PCB (Underside)

A	SO-DIMM B socket
B	SPI flash
C	DB40 connector
D	Mini PCIe
E	RTC battery
F	Clear CMOS jumper
G	Board to board connector (for DI/O board)
H	Fan connector
I	Internal reserved (5V, 3.3V for GPS module)
J	Internal reserved (12V, 5V)
K	XDP connector

Table 1-16: Mainboard PCB (Underside) Legend



NOTE:

Recommended expansion slot configuration options for MXC-6400 (not applicable for MXC-6310):

- ▶ 1 x PCI card + 1 x PCIe x16, with PCIe x8 slot empty

OR

- ▶ 1 x PCI card + 1 x PCIe x8 (in PCIe x8 slot)+ 1 x PCIe x8 (in PCIe x16 slot)

For best results, other configurations are not recommended

1.6.2 Backplane Connectors

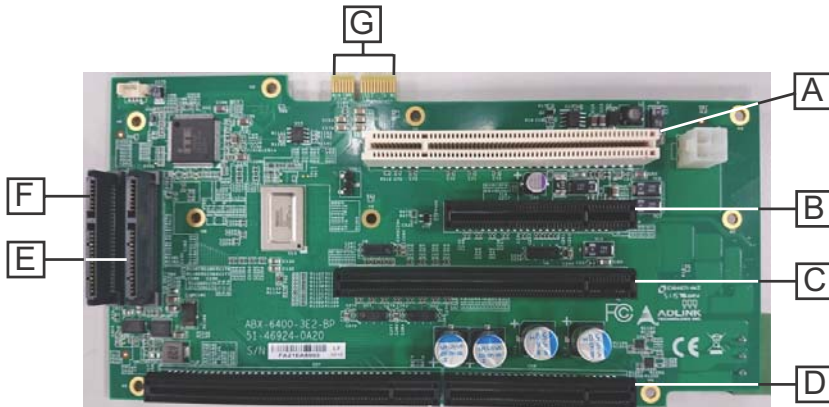

Figure 1-15: Backplane PCB (Top))

A	PCI slot
B	PCIe x8 slot
C	PCIe x16 slot
D	Board to board connector for mainboard
E	SATA Port2 slot
F	SATA Port1 slot
G	Edge connector for SATA board

Table 1-17: Backplane PCB (Top) Connector Legend

1.6.3 D/I/O & Daughter Board Connectors

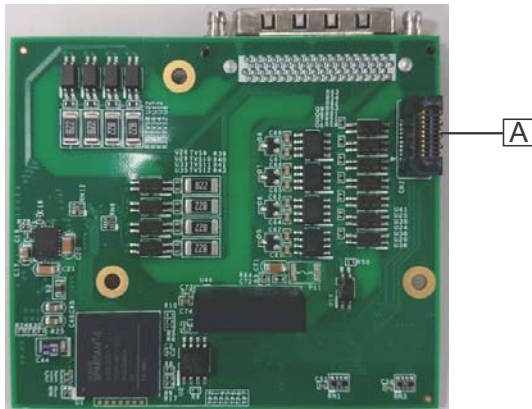

Figure 1-16: D/I/O Board PCB (Top)

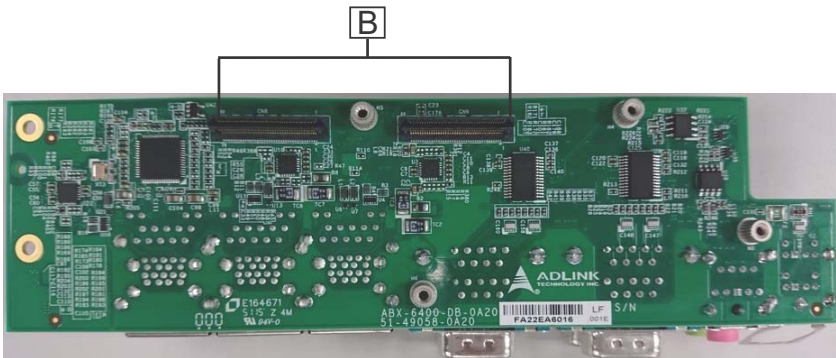

Figure 1-17: Daughter Board PCB (Underside)

A	Board to board connector for mainboard
B	Board to board connector for mainboard

Table 1-18: D/I/O & Daughter Board (Top) Connector Legend

1.6.4 SATA Board Connectors



Figure 1-18: SATA Board PCB (Top)

A	Board to board connector for mainboard
B	SATA Port3 slot
C	SATA Port4 slot

Table 1-19: Backplane PCB (Top) Connector Legend

1.6.5 Clear CMOS Jumper

Upon encountering an abnormal condition preventing the MXC-6400 from booting, the jumper can clear the BIOS content stored in CMOS and restore default settings. To clear CMOS, short pin #1 to pin #2 of JP1 and then remove the jumper to return to normal mode.



Normal	Clear
<p>JP1</p> 	<p>JP1</p> 

Table 1-20: Clear CMOS Jumper Settings

1.6.6 Internal Reserved +5V and +12V Connector

The MXC-6400 provides one power pin header with +5V and +12V DC power, providing access for PCI and PCI express card external power supplies.

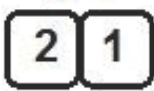
Please refer to Section A.2:Power Supply Reference for +5V and +12V connector power supply specifications

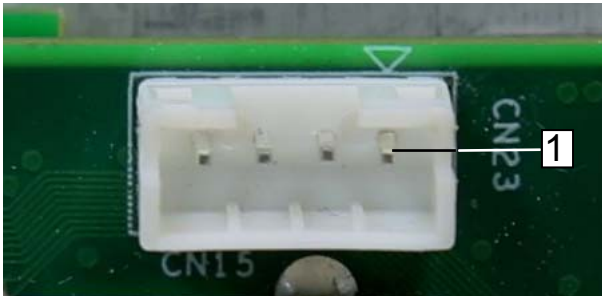

Figure 1-19: +5V and +12V Connector

Pin	Signal
1	+12V
2	GND
3	GND
4	+5V

Table 1-21: +5V and +12V Connector Pin Functions

1.6.7 Internal CFAST Card Connector

An internal Type II push-push CFAST socket connects to the host controller by SATA interface. Data transfer rates up to 3.0Gb/s (300MB/s) / 1.5Gb/s (150MB/s) are supported. The host SATA controller provides a legacy operating mode using I/O space, and an AHCI operating mode using memory space. The CFAST card can function as a storage device for system installation. Installation of a CFAST card is described in Section 2.5:Installing CFAST Cards.

1.6.8 12V DC Fan Connector

The MXC-6400 provides a DC 12V to USB connector for fan module power. The optional fan module connects to the connector when assembled to the chassis.

Fan speed changes with CPU temperature according to thermal sensor, initiating at 40°C(104°F), and reaching maximum speed at 80°C (176°F). The fan rotates at maximum speed when Power On Self Test begins.



The USB connector does not support standard USB connections, which may be damaged by the DC 12V power supply.

1.6.9 Internal USB Connector

The MXC-6400 provides an internal USB connector on the back board PCB.

1.6.10 SATA Connectors

The MXC-6400 provides 4 SATA ports, supporting up to 6.0Gb/s (600MB/s) transfer rate. The SATA host controller can be set to operate in IDE or AHCI mode in BIOS. This SATA connector is designed to support a 2.5 inch hard disk drive (HDD) or solid state disk (SSD). The HDD or SSD must be installed into the SATA connector with a HDD bracket. Please refer to Section 3.1 for installation of a 2.5 inch HDD or SSD.

1.6.11 USIM Port

Use of 3.5G mini-PCIe module requires a SIM card for communication with a telecom operator, received in the USIM port connected to the mini-PCIe connector, accepting a SIM card and 3.5G mini-PCIe module to facilitate 3.5G communication.

2 Getting Started

2.1 Unpacking Checklist

Before unpacking, check the shipping carton for any damage. If the shipping carton and/or contents are damaged, inform your dealer immediately. Retain the shipping carton and packing materials for inspection. Obtain authorization from your dealer before returning any product to ADLINK. Ensure that the following items are included in the package.

- ▶ MXC-6400 controller
- ▶ Accessory box
- ▶ Screw pack for wall-mounting and HDD mounting
- ▶ Quick Start Guide

2.2 Adaptors & Additional Accessories

Device adaptors and other optional accessories should only be obtained through your ADLINK dealer. For more information, see “Getting Service” on page 109.

2.3 Installing Hard Disk Drives

Installing Internal HDDs

Before installing hard disk drives, remove the top cover of the chassis first as follows.

1. Loosen the thumbscrew on the front panel by hand or screwdriver.

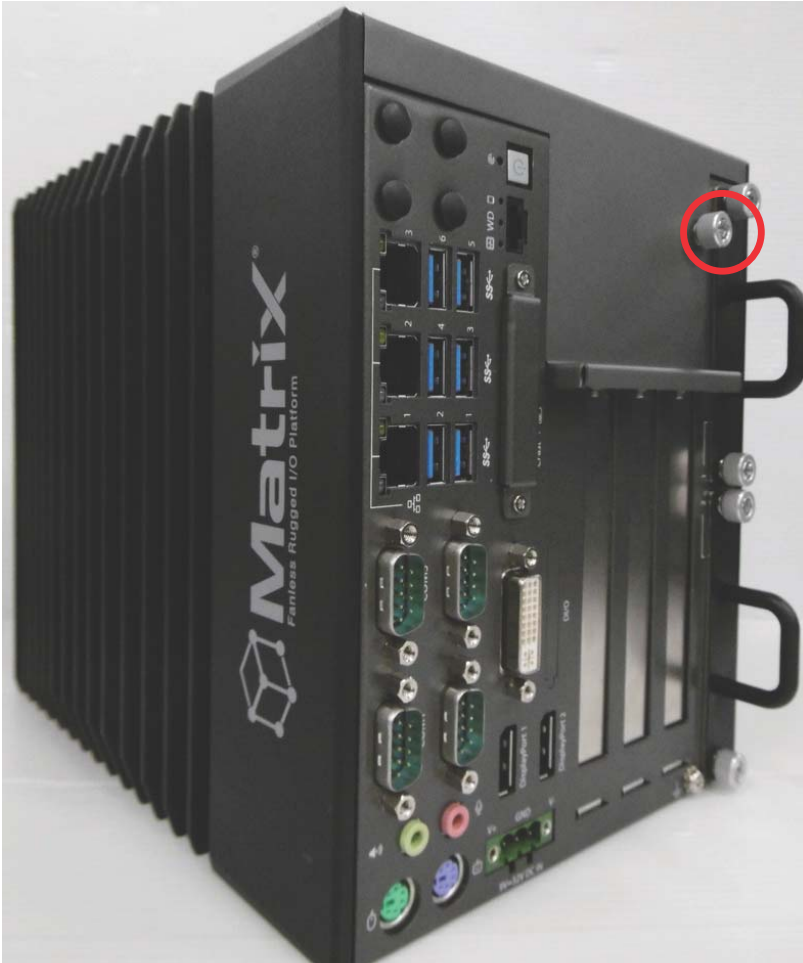

2. Withdraw the thumbscrew and remove the top cover by lifting.



3. Remove the 2 screws from the top of the HDD bracket.

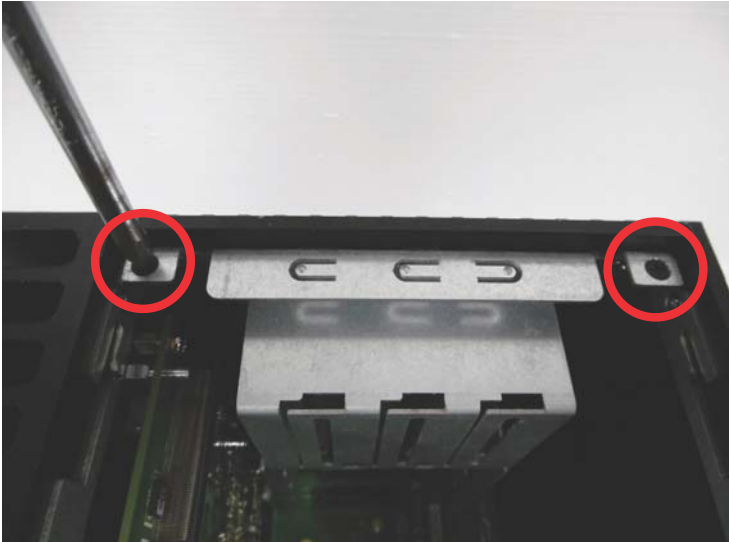

4. Place the chassis upside down and remove the other 2 screws from the bottom of the HDD bracket.



5. Slide the HDD bracket upward.



6. Use the 8 included M3 screws to fix one or two 2.5" HDD or SSD units to the bracket. The upper 2.5" HDD or SSD is SATA 2, and the lower SATA 1.



7. Gently push the HDD/SSD bracket down to the SATA connector on the PCB.



8. Reverse Steps 3 and 4 to fasten the 4 screws.
9. Replace the top cover and fasten the thumbscrew.

Installing Swappable SATA HDDs

1. Remove the four thumbscrews on the front panel by hand or screwdriver.

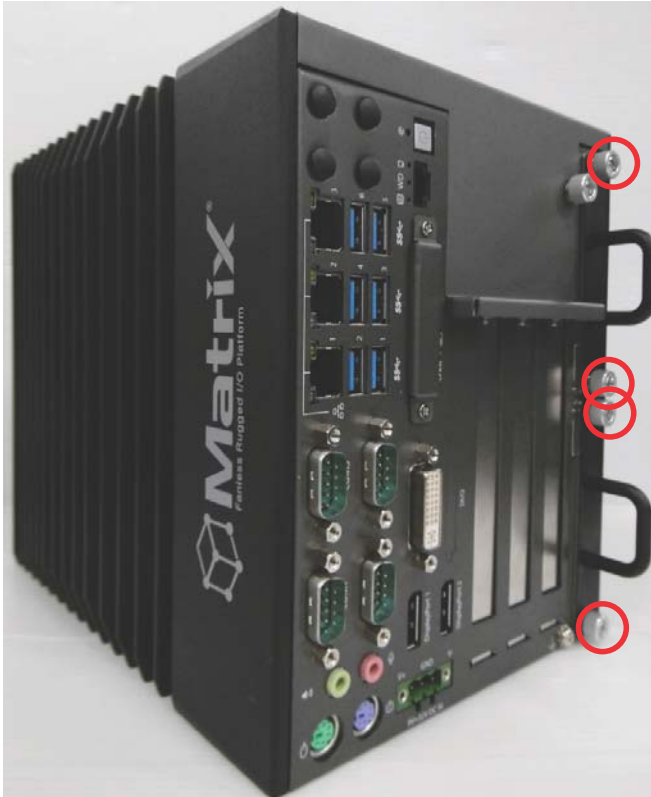

2. Withdraw one or both of the SATA trays.



3. Use the included M3 screws to fix a 2.5" HDD or SSD drive to one or each of the trays.



4. Return each tray into its slot and carefully slide inward until the drive is firmly seated in the SATA connector.
5. Refasten the 4 thumbscrews.

2.4 Installing a PCI/PCIe Card

Follow steps 1-2 in Section 2.3: Installing Hard Disk Drives to remove the top cover before installing a PCI/PCIe card.

1. Insert the PCI/PCIe card into the PCI/PCIe slot. Ensure that the lower edge of the PCI/PCIe card aligns with the alignment guide.

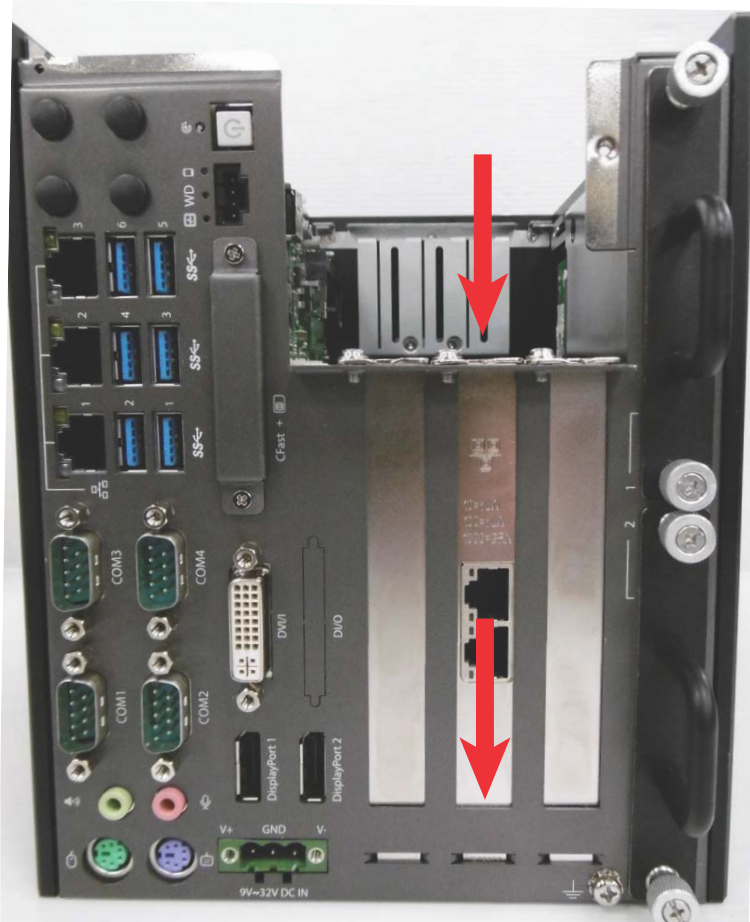

2. Adjust the position of the card brace to firmly fix the card.

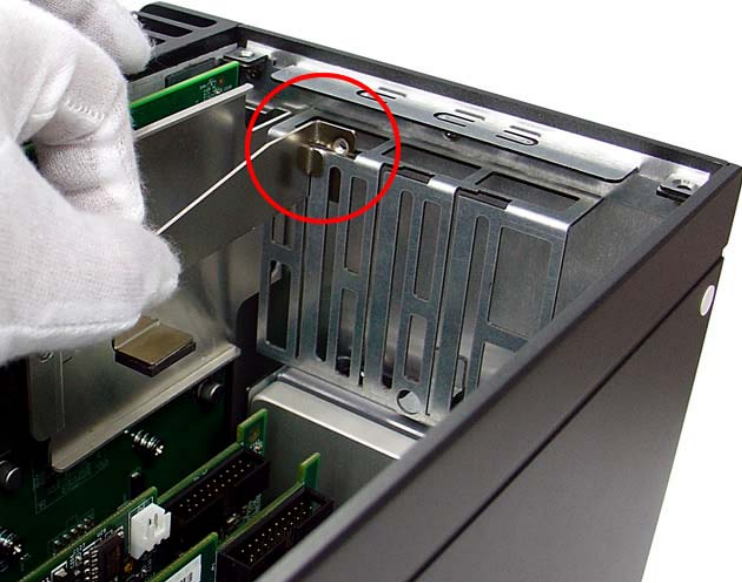

Tighten the screw to fix the brace.

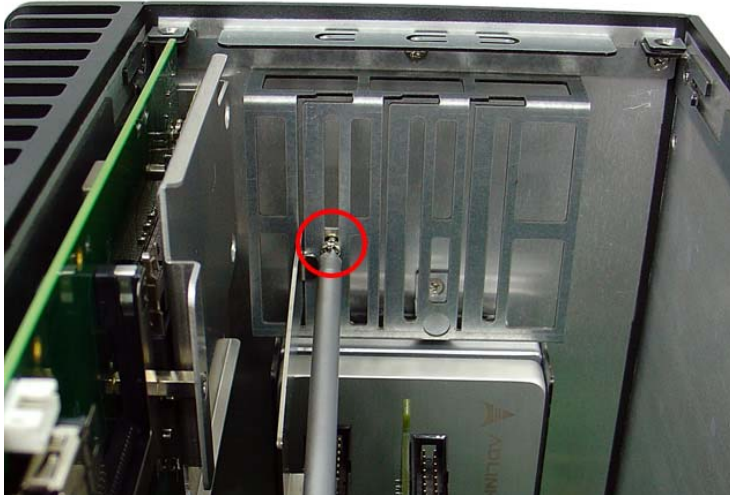

3. Replace the top cover and fasten the thumbscrew.

2.5 Installing CFast Cards

1. Remove the 2 screws securing the external CFast socket cover and remove the cover



- Align the CFast card with the guide in the CFast socket.



3. Gently insert the CFast card until it is firmly seated in the socket, as shown.



2.6 Connecting and Using DisplayPort Extension Devices

1. Connect a DisplayPort-to-DVI active adapter cable to the MXC-6400 DisplayPort jack.
2. Connect a DVI monitor to a single-mode DisplayPort output from the computer via a DisplayPort-to-DVI active adapter cable (P/N# 30-01157-0010)

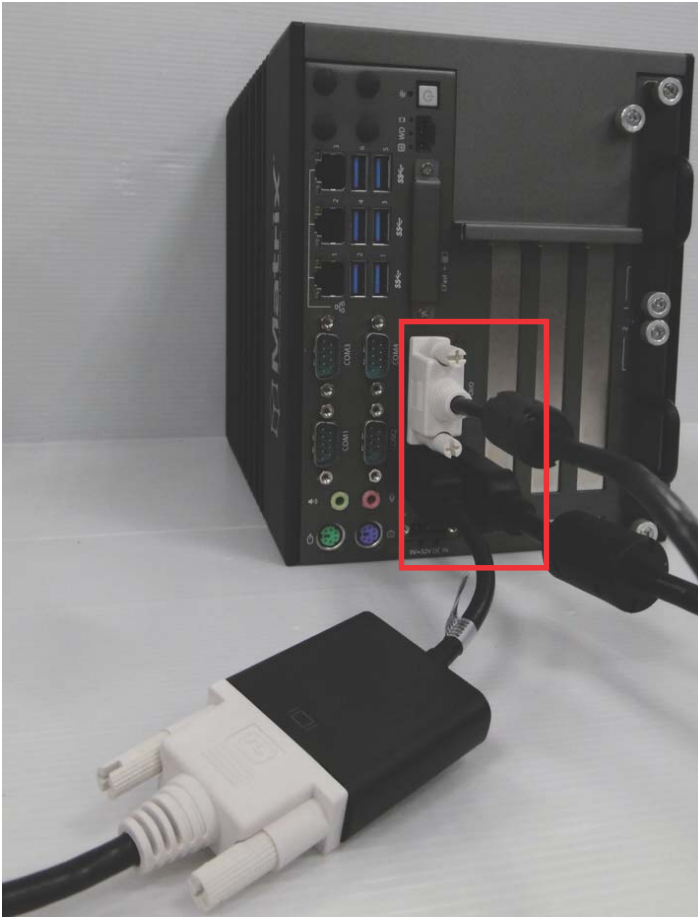

2.7 Connecting DC Power



Before connecting DC power to the MXC-6400, ensure voltage and polarity are compliant with the DC input. Improper input voltage or polarity can cause system damage.

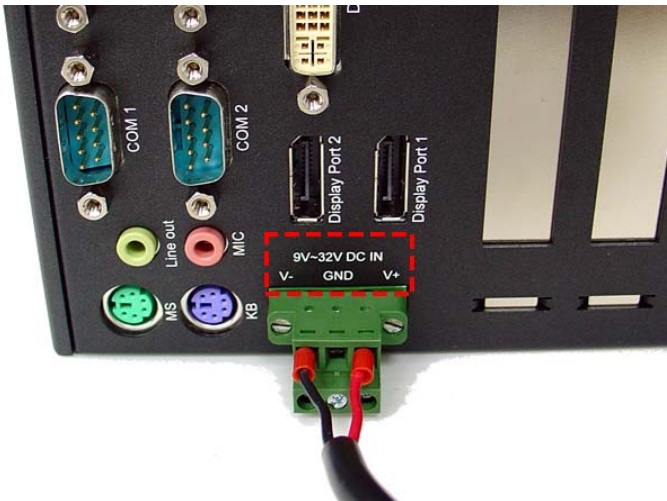

The DC power input connector of the MXC-6400 has V+, V- , and chassis ground pins, and accepts input voltage as shown previously. Connect DC power as shown. Two screws fasten to secure the plug.

2.8 Wall-mounting the MXC-6400



NOTE:

All dimensions shown are in mm (millimeters).

The MXC-6400 is shipped with wall-mount brackets and accessory screws.

Wall-mounting procedures follow.

1. Remove the 4 plastic pads from the corners.

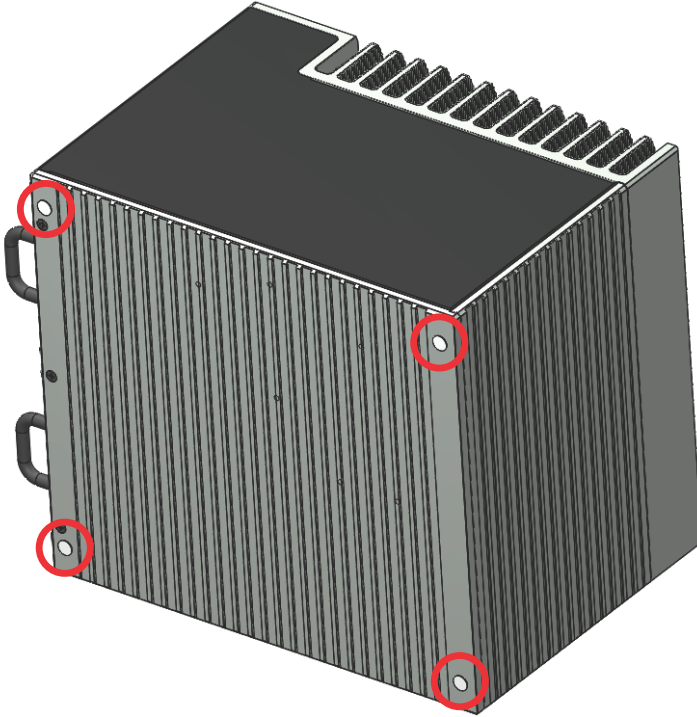

2. Use the 4 M4 screws shipped with the controller to fix the 2 wall-mount brackets, also included, to the chassis, according to the spacing dimensions of the screw holes and brackets, as shown.

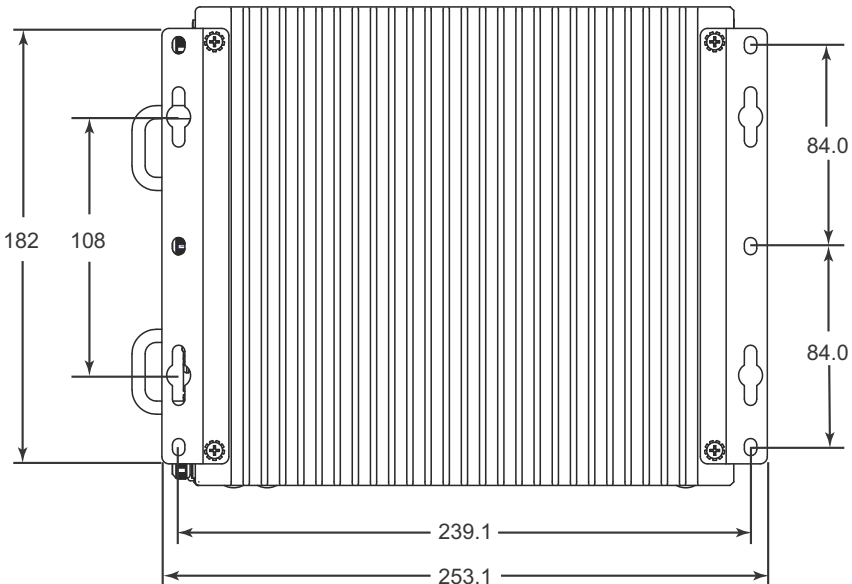
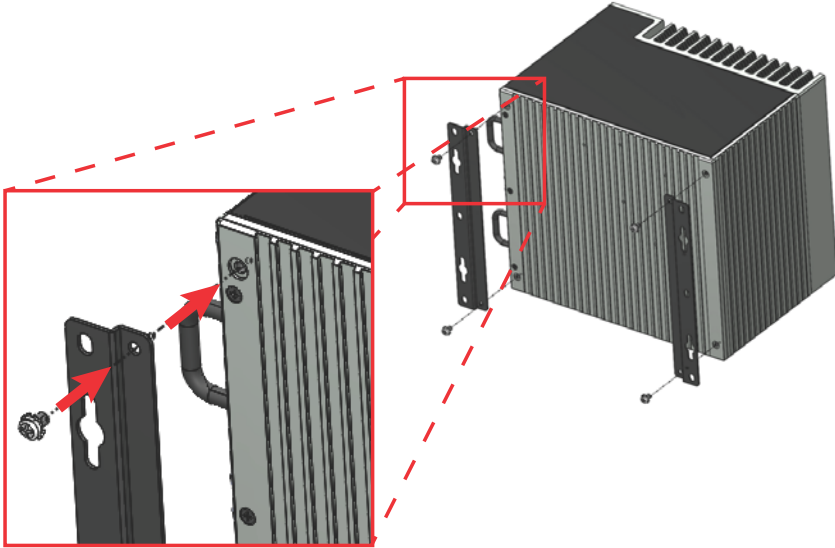

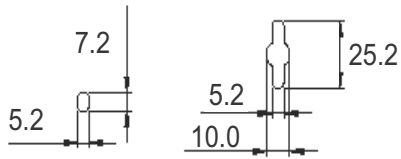

3. Once final assembly as shown is complete, mount the MXC-6400 on the wall via screw holes.



2.9 Optional Fan Module

The MXC-6400 can be optionally equipped with an easily installed fan module providing heat dissipation.

To install the fan module:

1. Follow steps 1-2 in section 2.3 to remove the top cover. Seat the fan module in the chassis.



2. Slide the fan module back until USB connection is secured, as shown.

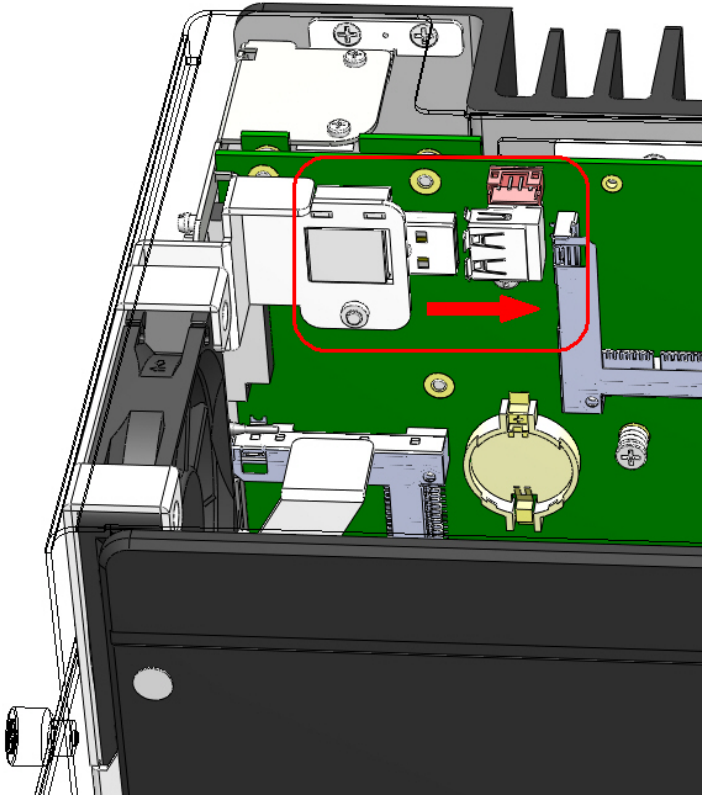

3. Replace the thumbscrews.

2.10 Cooling Considerations

Heat-generating components of the MXC-6400 (such as CPU and PCH) are all situated on the left side of the system. These components directly contact the heat sink via thermal pads and dissipate heat generated by the components. To maximize efficiency of heat dissipation, maintain a minimum of 2 inches (5 cm) clearance on the top of the MXC-6400 controller.

2.11 Driver Installation

Download requisite drivers, as follows, for your system from <http://www.adlinktech.com> and install.

The following drivers must be installed:

- ▶ Chipset driver
- ▶ Graphics driver
- ▶ Ethernet driver
- ▶ Audio driver
- ▶ USB 3.0 driver
- ▶ Intel® Management Engine driver
- ▶ Serial I/O driver

Appendix A Power Consumption



NOTE:

Information in this Appendix is for power budget planning and design purposes only. Actual power consumption may differ based on final application.

A.1 Power Consumption Reference

Power consumption as follows is based on lab data in which 24V DC is applied and current is measured by the DC power supply. The power consumption (W) is calculated as the product of applied voltage (V) and the current (A).

Platforms tested for this data have available external I/O interfaces, and are attached to supported devices such as VGA and DVI monitors, CFast card, PS2 keyboard/mouse, USB dummy load (5VDC 500mA), external SATA, COM loopback, and audio loopback, and an internal hard disk driver is installed.

No internal PCI/PCIe/mini PCIe slots are occupied.

Information is presented for reference only. Actual power consumption will vary with different attached devices and platform operations.

Power Supply (24VDC)	Power Off*	System Idle**	System Full Load***	Recommended Power Supply****
Integrated Embedded Computer				
MXC-6401D i7	4.412W	25.02W	63.132W	160W
MXC-6402D i5	4.412W	24.03W	58.162W	160W
MXC-6403D i3	4.412W	23.85W	56.88W	160W

Table A-1: Power Consumption



NOTE:

- ▶ Sufficient power supply for the entire system is required to meet these specifications. At least 100W at 24V input is recommended.
- ▶ Heat generated by add-on PCI/PCIe adapters affects thermal stability. Additional heat dissipation is required when the system operates at high temperatures or in harsh environments with add-on adapters.
- ▶ Power supply specifications shown are for total power consumption of all PCI/PCIe slots at once, not for single slot use.

A.2 Power Supply Reference

+3.3V Power Rail	Maximum 7A	Total Power Supply Max. 50W
+5V Power Rail	Maximum 5A	
+12V Power Rail	Maximum 2A	
-12V Power Rail	Maximum 0.2A	
CN23 +12V	Maximum 1A	
CN23 +5V	Maximum 1A	

Table A-2: Power Supply

A.3 Accessory Cabling

Power supply to add-on cards is provided by the auxiliary power cable (from CN23 to Molex 8981), Part Number 30-20724-0000.



Yellow	12V	Black	GND
Black	GND	Red	5V

Appendix B BIOS Setup

The Basic Input/Output System (BIOS) is a program that provides a basic level of communication between the processor and peripherals. In addition, the BIOS also contains codes for various advanced features applied to the MXC-6400. The BIOS setup program includes menus for configuring settings and enabling features of the MXC-6400. Most users do not need to use the BIOS setup program, as the MXC-6400 ships with default settings that work well for most configurations.

Enter BIOS setup by selecting DEL when the system is powered on the POST (Power On Self Test) message is displayed. The MXC-6400 controller supports one-time Boot Menu allowing selection of boot device. Enter the Boot Menu by selecting F7 at POST.



NOTE:

- ▶ BIOS options listed are for reference only
 - ▶ Different configurations can affect BIOS behavior
 - ▶ Displayed material may reflect only the BIOS version corresponding to initial release and may differ from that of the purchased motherboard
 - ▶ Users are welcome to download the latest BIOS version from our official website
-

B.1 Main

Contains basic system information for the MXC-6400.



WARNING:

Changing BIOS settings may lead to incorrect controller behavior and possible inability to boot. In such a case, See “Clear CMOS Jumper” on page 32. for instructions on clearing the CMOS and restoring default settings

```

Aptio Setup Utility - Copyright (C) 2015 American Megatrends, Inc.
Main Advanced Security Boot Save & Exit

BIOS Information
BIOS Vendor          American Megatrends
Core Version         5.11
BIOS Version         MXC6400 0.98.10
Board Version        A01

Platform Information
Name                 SkyLake DT
Stepping             Q0
Name                 SKL PCH-H
PCH SKU              PCH-H Mobile QM170
Stepping             20/C0
GT Info              GT2 (900 MHz)

F/W Information
Memory RC Version    1.8.0.1
Microcode Patch      1D
IGFX VBIOS Version   1028
ME FW Version        11.0.0.1153

System Date          [Thu 01/01/2015]
System Time          [00:02:27]

Access Level         Administrator

Set the Date. Use Tab to
switch between Date elements.

++: Select Screen
↑↓: Select Item
Enter: Select
+/-: Change Opt.
F1: General Help
F2: Previous Values
F3: Optimized Defaults
F4: Save & Exit
ESC: Exit
  
```

BIOS Information

Shows current system BIOS vendor, Core version, BIOS version and Board version.

Platform Information

Shows current system Platform name, CPU Stepping, PCH SKU, PCH Stepping and GT information.

F/W Information

Shows current system Memory RC version, Microcode Path, IGFX VBIOS version and ME FW version.

System Time/System Date

Allows adjustment of system time and date, as follows.

1. Highlight System Time or System Date using the up and down <Arrow> keys
2. Enter new values using the keyboard and select <Enter>
3. Select < Tab > to move between fields.



NOTE:

- ▶ The date must be entered in MM/DD/YY format, and the time in HH:MM:SS.
- ▶ The time is in 24-hour format. For example, 5:30 A.M. appears as 05:30:00, and 5:30 P.M. as 17:30:00.

B.2 Advanced

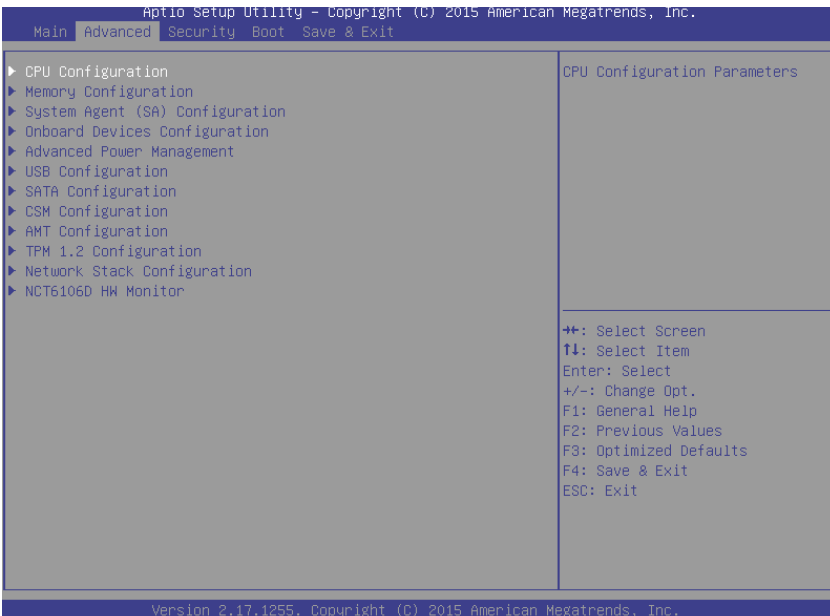

CAUTION:

Setting incorrect or conflicting values in Advanced BIOS Setup may cause system malfunction

Accesses advanced options of the MXC-6400.

B.2.1 CPU Configuration

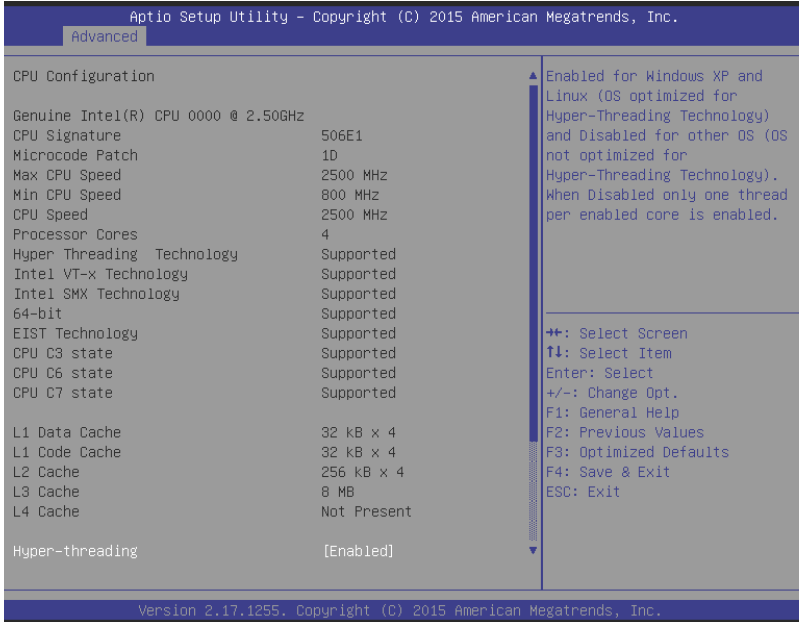

Hyper-Threading

Enabled for Windows XP and Linux (OS optimized for Hyper-Threading Technology) and Disabled for other OS (OS not optimized for Hyper-Threading Technology), with only one thread per enabled core enabled when Disabled.

Active Processor Cores

Number of cores to enable in each processor package.

Intel® Virtualization Technology

When enabled, a VMM can utilize the additional hardware capabilities provided by Vanderpool Technology.

CPU AES

Enables/disables CPU Advanced Encryption Standard instructions.

Intel® SpeedStep(tm)

Allows more than two frequency ranges to be supported.

CPU C States

Enables/disables CPU C states.

Intel® TXT(LT) Support

Enables/disables Intel® TXT(LT) support.

TCC Activation Offset

Offset from the factory TCC activation temperature.

B.2.2 Memory Configuration

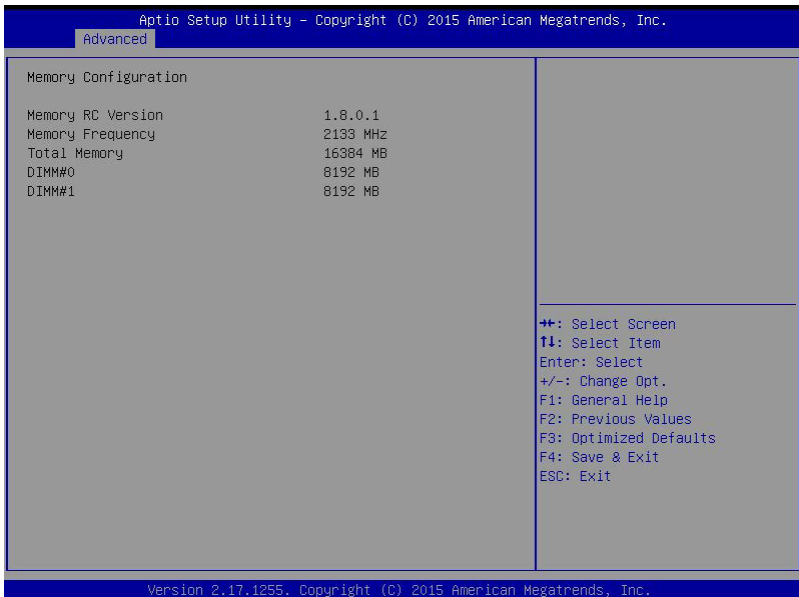

Shows current system memory RC version, memory frequency, total memory, DIMM#0 and DIMM#1.

B.2.3 System Agent (SA) Configuration



VT-d

VT-d capability

B.2.4 Graphics Configuration

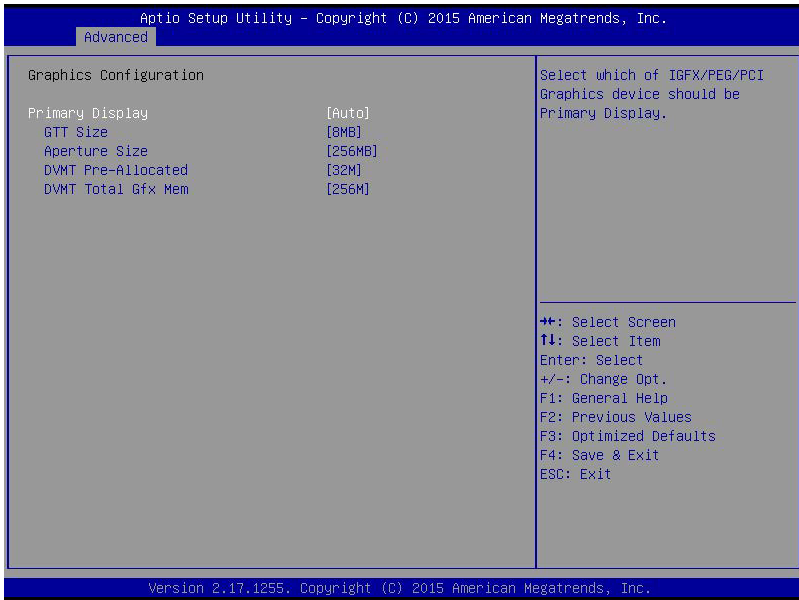

Primary Display

Selects graphics device for primary display, from among IGFX/PEG/PCI.

GTT Size

Selects GTT Size.

Aperture Size

Selects aperture size, with MMIO BIOS assignment exceeding 4GB automatically enabled when 2048MB aperture is selected, requires CSM Support to be disabled.

DVMT Pre-Allocated

Selects DVMT 5.0 pre-allocated (fixed) graphics memory size used by internal graphics device.

DVMT Total Gfx Mem

Selects DVMT5.0 total graphic memory size used by internal graphics device.

B.2.5 Onboard Device Configuration

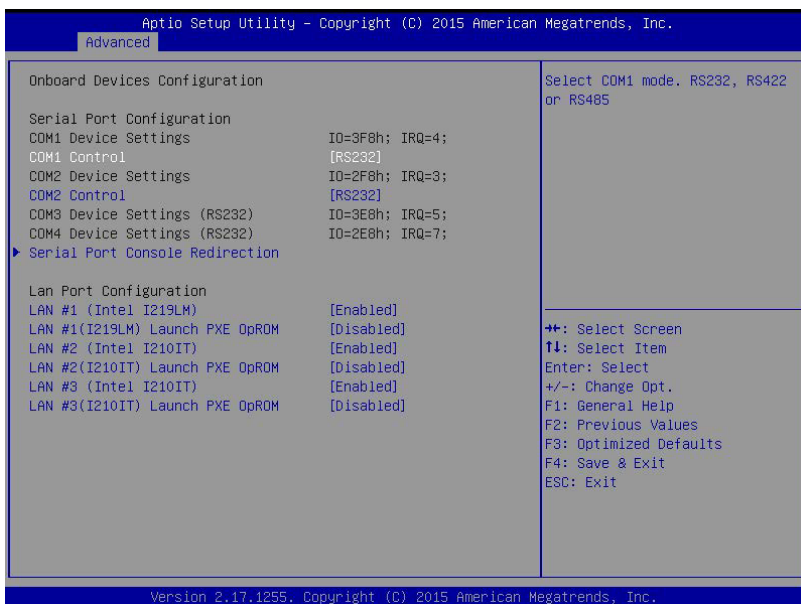

Serial Port 1 to 4 Configuration

Allows selection of port type (RS-232/422/485) for Serial Ports 1 and 2 only

LAN #1 (Intel® I219LM)

Enables/disables onboard Intel® I219LM LAN controller.

LAN #1(I219LM) Launch PXE OpROM

Enables/disables execution of LAN boot-rom to add boot option for legacy network devices.

LAN #2 (Intel® I210IT)

Enables/disables onboard Intel® I210IT LAN controller.

LAN #2(I210IT) Launch PXE OpROM

Enables/disables execution of LAN boot-rom to add boot option for legacy network devices.

LAN #3 (Intel® I210IT)

Enables/disables onboard Intel® I210IT LAN controller.

LAN #3 (I210IT) Launch PXE OpROM

Enables/disables execution of LAN boot-rom to add boot option for legacy network devices.

B.2.5.1 Serial Port Console Redirection

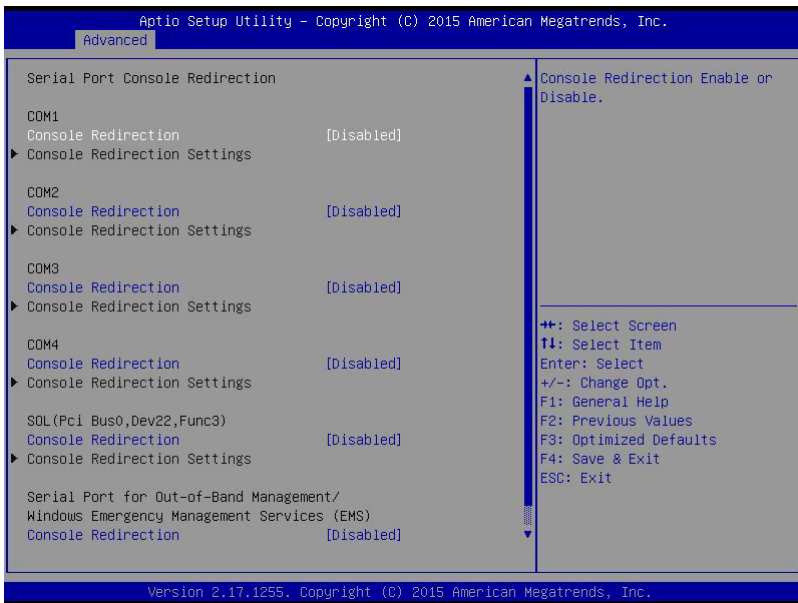

Serial Console for COM 1 to 4, SOL (Serial Over LAN) and EMS COM.

Console Redirection

Enables Console Redirection on COM 1 to 4, SOL and EMS COM.

Console Redirection Settings

Miscellaneous parameters for COM Ports 1 to 4, SOL and EMS COM.

B.2.6 Advanced Power Management



State After G3

Specifies desired state entered when power is resumed following outage (G3 state), from among Last State, Power On, and Power Off

Option	Description
Power Off	Retains system power off after power is restored
Power On	Powers the system up when power is restored
Last State	When power is restored, returns the system to the state in which power was interrupted

RTC Wake system from S5

Enables/disables System wake on alarm event, with FixedTime waking on the hr::min::sec specified, DynamicTime waking on the current time + Increase minute(s).

BIOS POST Watchdog

Disable disables WatchDog Timer, Second Mode enables Watchdog Timer in second mode, and Minute Mode enables Watchdog Timer in minute mode.

B.2.7 USB Configuration

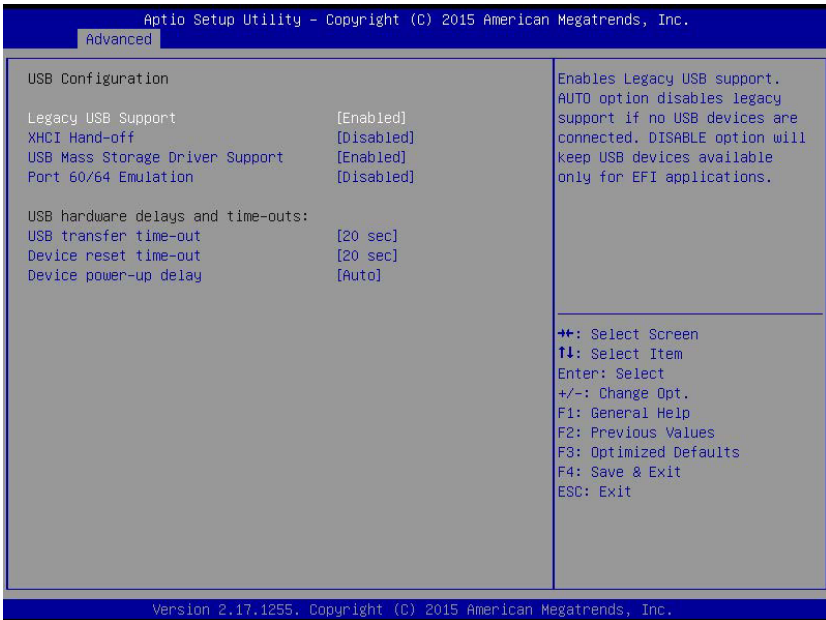

Legacy USB Support

Enables Legacy USB support, with AUTO disabling legacy support if no USB devices are connected, and DISABLE keeping USB devices available only for EFI applications.

XHCI Hand-off

A workaround for OS with no XHCI hand-off support, with XHCI ownership change claimed by XHCI driver.

USB Mass Storage Driver Support

Enables/disables USB Mass Storage Driver Support.

Port 60/64 Emulation

Enables I/O port 60h/64h emulation support, should be enabled for complete USB keyboard legacy support with non-USB recognizing OS.

USB transfer time-out

Timeout value for Control, Bulk, and Interrupt transfers.

Device reset time-out

USB mass storage device Start Unit command timeout.

Device power-up delay

Maximum delay invoked before the device routinely registers with the Host Controller, with Auto using default value for a Root port of 100 ms, and for a Hub port the value acquired from Hub descriptor.

B.2.8 SATA Configuration

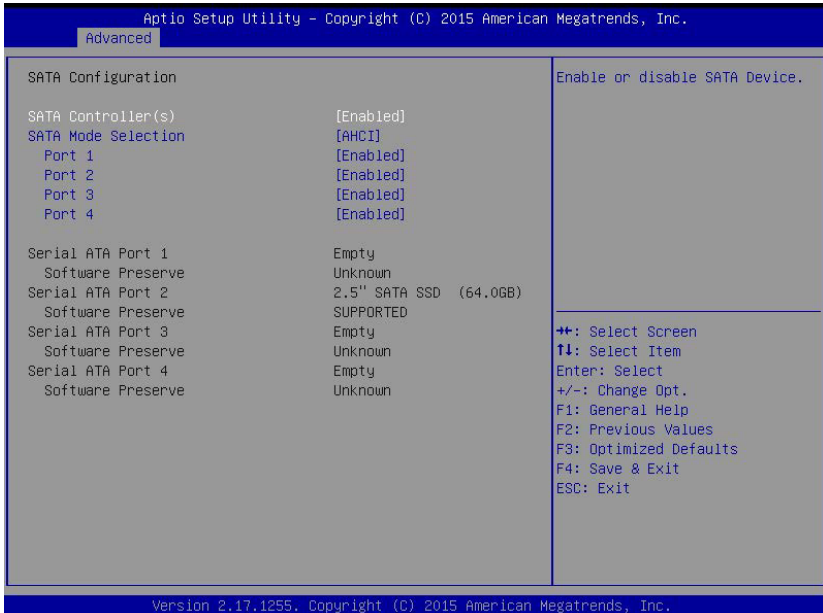

SATA Controller(s)

Enables/disables SATA device.

SATA Mode Selection

Selects SATA controller(s) operating mode.

Port 1 to 4

Enables/disables SATA ports 1 to 4.

B.2.9 CSM Configuration

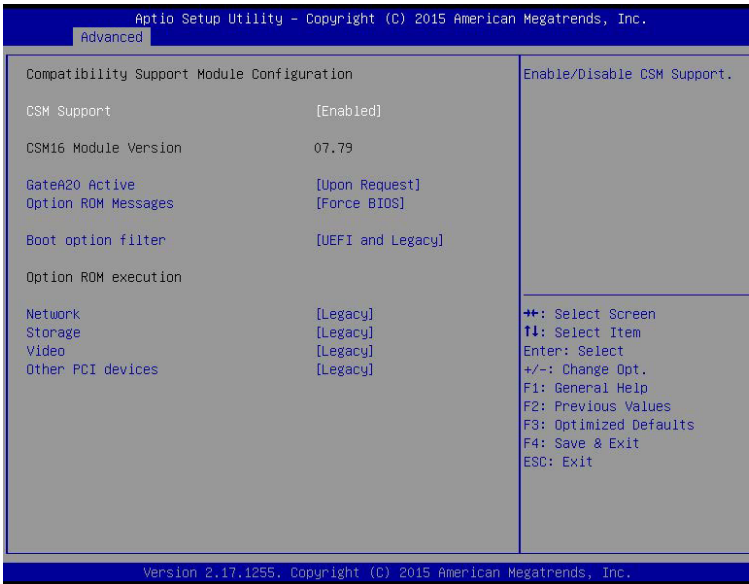

CSM Support

Enables/disables CSM Support.

GateA20 Active

UPON REQUEST allows GA20 to be disabled using BIOS services, ALWAYS prevents GA20 from being disabled, used when any RT code over 1MB is executed.

Option ROM Messages

Sets display mode for Option ROM.

Boot option filter

Sets Legacy/UEFI ROM priority.

Network

Controls execution of UEFI and Legacy PXE OpROM.

Storage

Controls execution of UEFI and Legacy Storage OpROM.

Video

Controls execution of UEFI and Legacy Video OpROM.

Other PCI devices

Determines OpROM execution policy for devices other than Network, Storage, or Video.

B.2.10 AMT Configuration

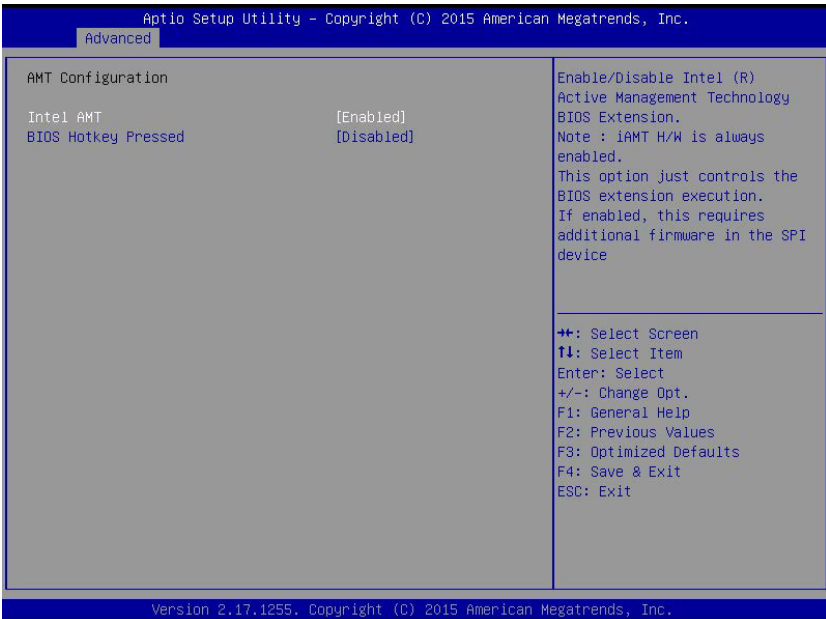

Intel® AMT

Enables/disables Intel® Active Management Technology BIOS extension only, where iAMT H/W is always enabled, and requiring, when enabled, installation of additional firmware in the SPI device.

BIOS Hotkey Pressed

OEMFLag Bit 1: Enables/disables BIOS hotkey press.

B.2.11 TPM 1.2 Configuration



Security Device Support

Enables/disables BIOS support for security device, not shown by OS, and rendering TCG EFI protocol and INT1A interface unavailable.

TPM State

Enables/disables security device, where the computer reboots during restart to change device state.

Pending Operation

Schedules operations for the security device, where the computer reboots during restart to change security device state.

B.2.12 Network Stack Configuration

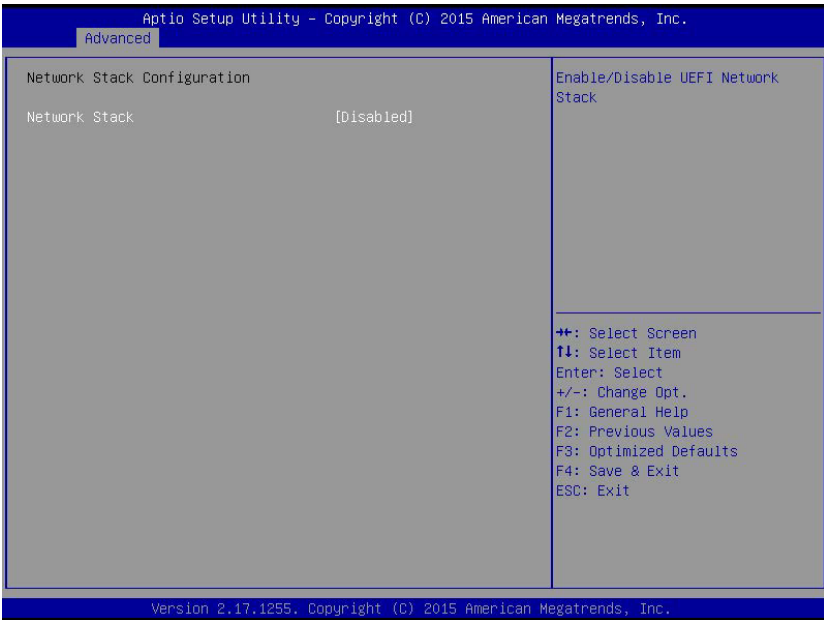

Network Stack

Enables/disables UEFI Network Stack.

B.2.13 NCT6106D HW Monitor

Aptio Setup Utility - Copyright (C) 2015 American Megatrends, Inc.

Advanced

<p>PC Health Status</p> <pre> Board Temperature : +37 °C CPU Temperature : +39 °C Fan Speed : N/A Fan1 Control Mode [SMART FAN IV] T1 1 T1 Duty 40 T2 40 T2 Duty 40 T3 60 T3 Duty 126 T4 80 T4 Duty 212 Critical 90 +VDDCORE : +1.128 V +12V_S : +11.904 V +5V_S : +4.929 V +3.3V_S : +3.251 V +3.3V_A : +3.264 V +3.3V_BAT : +2.880 V </pre>	<p>Fan1 Control Mode Select</p> <hr/> <pre> +/: Select Screen ↑↓: Select Item Enter: Select +/-: Change Opt. F1: General Help F2: Previous Values F3: Optimized Defaults F4: Save & Exit ESC: Exit </pre>
---	---

Version 2.17.1255. Copyright (C) 2015 American Megatrends, Inc.

Fan Control Mode

Selects fan control mode.

B.3 Security

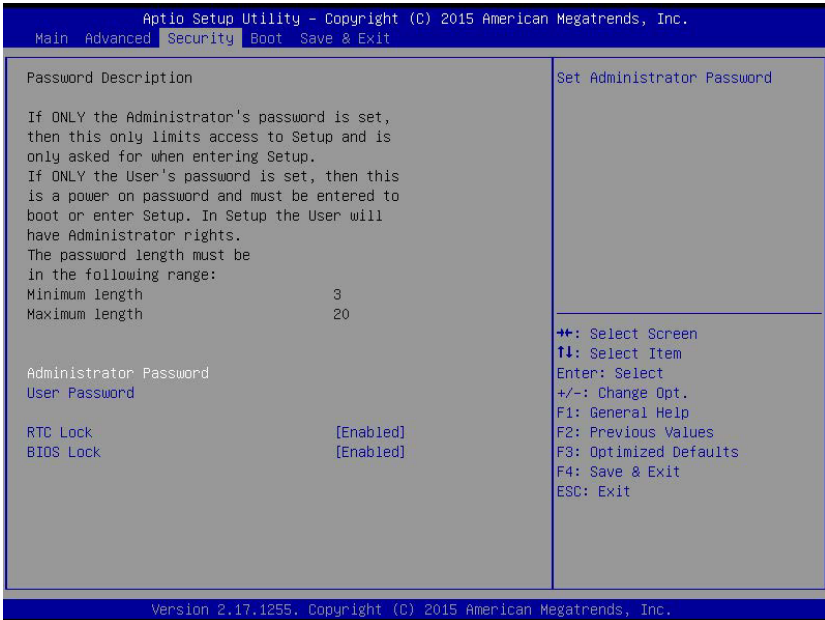

When only Administrator password is set, access to Setup is limited and password requested when entering, if only User password is set, it must be entered to boot or enter setup, after which user receives Administrator rights.

Administrator Password

Sets Administrator password.

User Password

Sets User password.

RTC Lock

When enabled locks bytes 38h-3Fh in the lower/upper 128-byte bank of RTC RAM.

BIOS Lock

Enables/disables PCH BIOS Lock Enable (BLE bit).

B.4 Boot

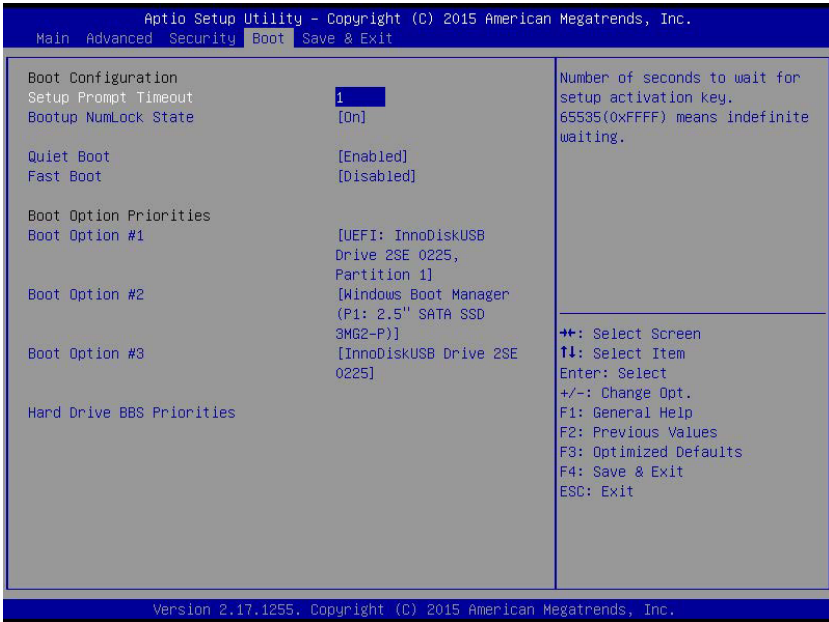

Setup Prompt Timeout

Sets wait time for setup activation key, with 65535 (0xFFFF) setting indefinite wait.

Bootup Num-Lock State

Sets keyboard NumLock state.

Quiet Boot

Option	Description
Disabled	Directs BIOS to display POST messages
Enabled	Directs BIOS to display the OEM logo.

Fast Boot

Option	Description
Disabled	Directs BIOS to perform all POST tests.
Enabled	Directs BIOS to skip certain POST tests to boot faster.

Enabling Fast Boot may reduce system ready time, but some prerequisites can reduce the effectiveness

Boot Option Priorities

Specifies the priority of boot devices, all of which are detected during POST and displayed.

Move the cursor to target Boot Option # and click to select the desired device

Hard Drive BBS Priorities

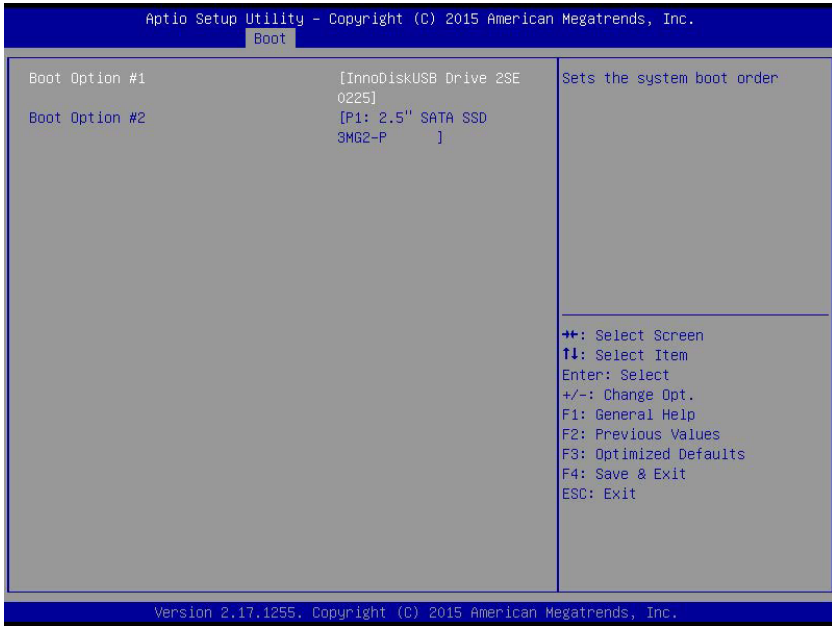

Specifies the priority of boot devices. All installed boot devices are detected during POST and displayed. Move the cursor to target Boot Option # and select.

B.5 Save & Exit

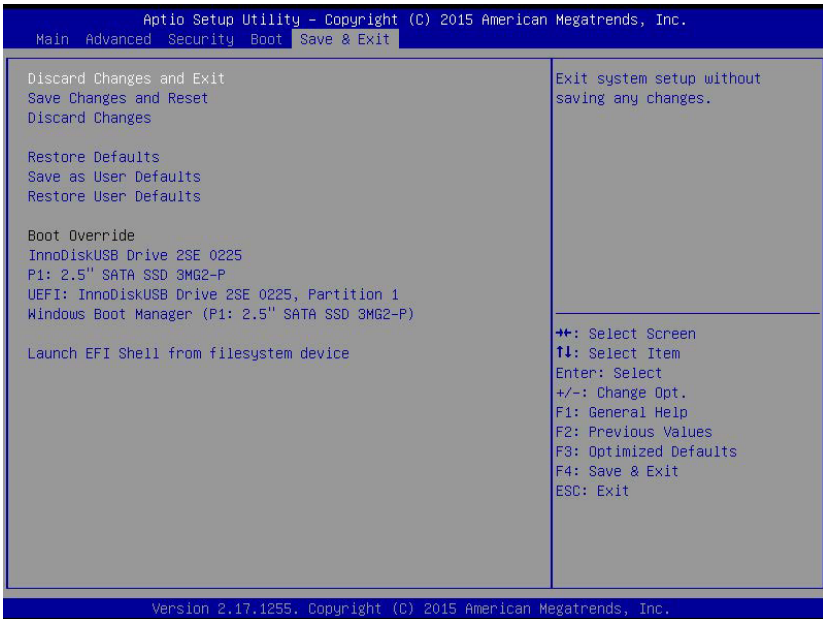

Discard Changes and Exit

Exits setup without saving any changes.

Save Changes and Reset

Saves all changes and reboots the system, with new settings taking effect

Discard Changes

Resets system setup without saving any changes

Restore Defaults

Restore/Load Default values for all Setup options.

Save as User Defaults

Saves all changes to this point as user defaults

Restore User Defaults

Restores user defaults to all setup options

Launch EFI Shell from filesystem device

Attempts to launch EFI Shell application (Shell.efi) from one of the available filesystem devices

Appendix C Activating RAID Function

The Matrix MXC-6400 utilizes Intel® Rapid Storage Technology provided by the Intel® QM77 chipset, and supports RAID 0 and RAID 1 levels, differentiated as follows.

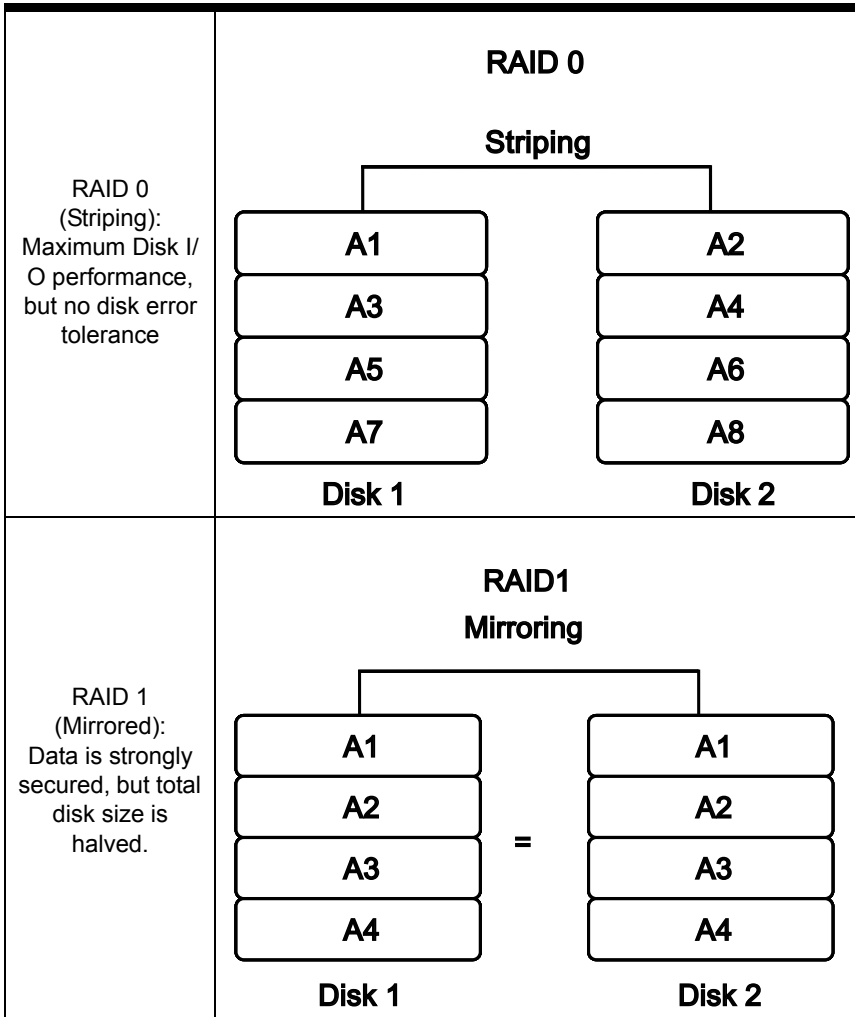

RAID function is disabled by default. Activation procedures are as follows.

Ensure all data on the disks to be used in the RAID array is fully backed up.

Refer to section 2.3 to install the two hard disks in the chassis.



CAUTION:

It is strongly recommended that both HDDs are the same model and size for maximal compatibility.

C.1 RAID Activation in System Management

1. In the BIOS menu, enter “SATA Configuration” under “Advanced” tab



2. Set SATA Mode to “RAID Mode”, and save and exit BIOS.



C.1.1 Intel® Matrix Storage Manager

After the SATA is set to RAID mode, the Intel® Matrix Storage Manager appears in POST.

1. Select "Ctrl + I" to enter the utility when prompted.

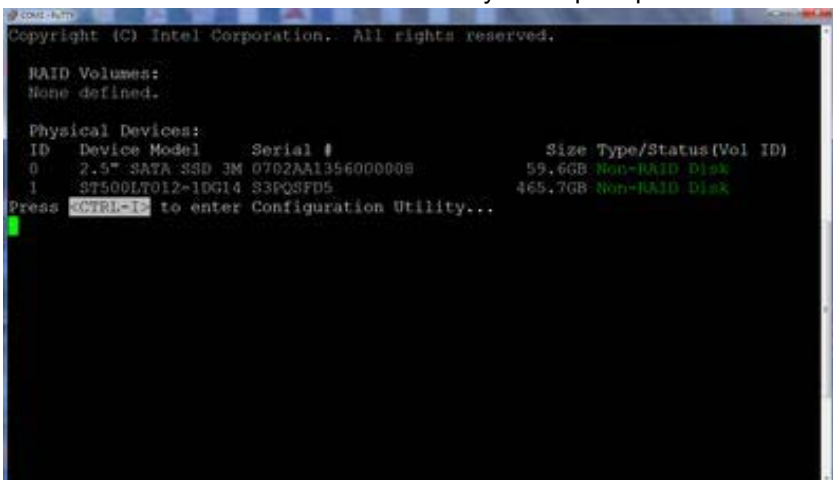



4. After the RAID volume has been created, it appears in the RAID volume list.



This page intentionally left blank.

Appendix D Watchdog Timer (WDT) Function Library

This appendix describes use of the watchdog timer (WDT) function library for the MXC-6400 controller. The watchdog timer is a hardware mechanism provided to reset the system if the operating system or an application stalls. After starting, the watchdog timer in the application must be periodically reset before the timer expires. Once the watchdog timer expires, a hardware-generated signal is sent to reset the system.

D.1 WDT with API/Windows

Matrix WDT API library files and a demo program (incl. source code) can be found on the included driver CD or downloaded from <http://www.adlinktech.com>.

To use the WDT function library for MXC-6400, include the header file `WDT.h` and linkage library `WDT.lib` in the C++ project.

InitWDT

Initializes the watchdog timer function. Must be called before the invocation of any other WDT function.

Syntax

C/C++

```
BOOL InitWDT()
```

Parameters

None

Return codes

TRUE if watchdog timer is successfully initialized.

FALSE if watchdog timer fails to initialize.

SetWDT

Sets the timeout value of the watchdog timer. There are two parameters for this function to indicate the timeout ticks and

unit. ResetWDT or StopWDT should be called before the expiration of watchdog timer, or the system will reset.

Syntax

C/C++

```
BOOL SetWDT(BYTE tick, BYTE unit)
```

Parameters

tick

Specify the number of ticks for watchdog timer. A valid value is 1 - 255.

unit

Specifies the timeout ticks of the watchdog timer.

Value	Description
0	The unit for one tick is one second. For example, when one tick is specified as 100 and the unit as 0, the timeout value is 100 seconds.
1	The unit for one tick is one minute. For example, when one tick is specified as 100 and the unit as 1, the timeout value is 100 minutes.

Return codes

TRUE if timeout value of watchdog timer is successfully set.

FALSE if timeout value of watchdog timer is failed to set.

StartWDT

Start the watchdog timer function. Once the StartWDT is invoked, the watchdog timer starts. ResetWDT or StopWDT should be called before the expiration of watchdog timer, or the system will reset.

Syntax

C/C++

```
BOOL StartWDT()
```

Parameters

None

Return codes

TRUE if watchdog timer is successfully started.

FALSE if watchdog timer is failed to start.

ResetWDT

Reset the watchdog timer. The invocation of ResetWDT allows restoration of the watchdog timer to the initial timeout value specified in SetWDT function. ResetWDT or StopWDT should be called before the expiration of the watchdog timer, or the system will reset.

Syntax

C/C++

```
BOOL ResetWDT()
```

Parameters

None

Return codes

TRUE if watchdog timer is successfully reset.

FALSE if watchdog timer fails to reset.

StopWDT

Stops the watchdog timer.

Syntax

C/C++

```
BOOL StopWDT()
```

Parameters

None

Return codes

TRUE if watchdog timer is successfully stopped.

FALSE if watchdog timer fails to stop.

D.2 WDT with DOS/Linux

Under Linux, please program WDT function using the same LPC IO registers according to the sample program as follows.

```
#include <dos.h>
#include <stddef.h>
#include <stdio.h>

/* Config LPC IO ITE8783 to enter config mode */
EnterConfig(void)
{
    outp(0x2E, 0x87);
    outp(0x2E, 0x01);
    outp(0x2E, 0x55);
    outp(0x2E, 0x55);}

/* Config LPC IO to exit config mode */
ExitConfig(void)
{
    outp(0x2E, 0x02);
    outp(0x2F, 0x02);
}

/* Read byte from LPC IO register */
unsigned char r_reg(unsigned char regoffset)
{
    outp(0x2E, regoffset);
    return inp(0x2F);
}

/* Write byte to LPC IO register */
```

Appendix E Digital Input/Output Function Library

ADMX_DIO_Init

Reserves system resources for digital input/output API service. Must be called before using other MXC-6400 `matrix_dio` functions.

Syntax

C/C++, Linux C/C++, and Borland C++

```
I16 ADMX_DIO_Init(void)
```

Visual Basic

```
ADMX_DIO_Init () As Integer
```

Parameter(s)

None

Return codes

```
NoError  
ErrorOpenDriverFailed  
ErrorDeviceIoctl
```

ADMX_DIO_Close

Instructs the MXC-6400 `matrix_dio` library that DI/O is currently idle and may be released. Required at the end of a program to release all system resources.

Syntax

C/C++, Linux C/C++, and Borland C++

```
I16 ADMX_DIO_Close(void)
```

Visual Basic

```
ADMX_DIO_Close () As Integer
```

Parameter(s)

None

Return codes

NoError

DI_ReadPort

Reads digital data from the specified digital input port.

Syntax

C/C++ and Borland C++

```
I16 DI_ReadPort (U32 *Value)
```

Visual Basic

```
DI_ReadPort (Value As Long) As Integer
```

Parameter(s)

Value

Returns the digital data read from the specified port

Valid values include MXC-6400 16-bit data

Return codes

NoError

CardNotRegistered

ErrorInvalidCardNumber

ErrorCardNotRegistered

ErrorFuncNotSupport

DO_WritePort

Writes digital data to the specified digital output port.

Syntax

C/C++ and Borland C++

```
I16 DO_WritePort (U32 Value)
```

Visual Basic

```
DO_WritePort (ByVal Value As Long) As Integer
```

Parameter(s)

Value

Digital data written to the specified port

Valid values include: MXC-6400 16-bit data

Return codes

```
NoError
ErrorInvalidCardNumber
ErrorCardNotRegistered
ErrorFuncNotSupport
ErrorInvalidIoChannel
```

DO_ReadPort

Reads back digital data output from the specified digital output port.

Syntax

C/C++ and Borland C++

```
I16 DO_ReadPort (U32 *Value)
```

Visual Basic

```
DO_ReadPort (Value As Long) As Integer
```

Parameter(s)

Value

Returns the digital data read from the specified output port.

Valid values include: MXC-6400 16-bit data

Return codes

```
NoError
ErrorInvalidCardNumber
ErrorCardNotRegistered
ErrorFuncNotSupport
ErrorInvalidIoChannel
```

DI_ReadLine

Reads the digital logic state of the digital line in the specified port.

Syntax

C/C++ and Borland C++

```
I16 DI_ReadLine (U16 Line, U16 *State)
```

Visual Basic

```
DI_ReadLine (ByVal Line As Integer, State As  
Integer) As Integer
```

Parameter(s)

Line

Digital line to be read.

Valid values include: MXC-6400 0 to 15

State

Returns the digital logic state of the specified line to 0 or 1

Return codes

```
NoError  
ErrorInvalidCardNumber  
ErrorCardNotRegistered  
ErrorFuncNotSupport  
ErrorInvalidIoChannel
```

DO_WriteLine

Sets the specified digital output line in the specified digital port to the specified state. Only available for cards supporting DO readback.

Syntax

C/C++ and Borland C++

```
I16 DO_WriteLine (U16 Line, U16 State)
```

Visual Basic

```
DO_WriteLine(ByVal Line As Integer, ByVal State  
As Integer) As Integer
```

Parameter(s)

Line

Digital line to be read.

Valid values include: MXC-6400 0 to 15

State

New digital logic state 0 or 1.

Return codes

```
NoError
```

```
ErrorInvalidCardNumber
ErrorCardNotRegistered
ErrorFuncNotSupport
ErrorInvalidIoChannel
```

DO_ReadLine

Reads back the digital logic state of the specified digital output line of the specified port.

Syntax

C/C++ and Borland C++

```
I16 DO_ReadLine (U16 Line, U16 *State)
```

Visual Basic

```
DO_ReadLine (ByVal Line As Integer, State As
             Integer) As Integer
```

Parameter(s)

Line

Digital line to be read.

Valid values include: MXC-6400 0 to 15

State

Returns the digital logic state, 0 or 1, of the specified line

Return codes

```
NoError
ErrorInvalidCardNumber
ErrorCardNotRegistered
ErrorFuncNotSupport
ErrorInvalidIoChannel
```

DIO_INT_Event_Message

Controls and notifies user application when a specified interrupt event occurs. Notification is implemented through a user-specified callback function or the Windows PostMessage API. When a new event message is added, it remains active until the function is called by setting the argument mode to 0, removing the specified interrupt event message. To remove a

specified message, the event handle for the message must be identified.

Syntax

C/C++ and Borland C++

```
I16 DIO_INT_EventMessage (I16 mode, HANDLE evt,  
HANDLE windowHandle, U32 message, U32  
callbackAddr)
```

Visual Basic

```
DIO_INT_EventMessage (ByVal mode As Integer,  
ByVal evt As Long, ByVal windowHandle As  
Long, ByVal message As Long, ByVal  
callbackAddr As Long) As Integer
```

Parameter(s)

mode

Operation mode of adding or removing message, with
0 Removes an existing message interrupt event defined argu-
ment event

1 Adds a new message for an interrupt event defined

evt

Handle of the INT event to be handled.

windowHandle

Handle to the destination window for a Windows message when the specified INT event occurs. If windowHandle is 0, no Windows messages will be sent.

message

User-defined message. When the specified INT event occurs, MXC-6400 matrix_dio remits this message. The message can be of any value. In Windows, the message can be set to a value including any Windows predefined messages, such as WM_PAINT. However, to define a designated message, any value ranging from WM_USER (0x400) to 0x7fff can be used. This range is reserved by Windows for user-defined messages.

callbackAddr

Address of the user callback function. The MXC-6400 `matrix_dio` calls this function when the specified INT event occurs. If no callback function is desired, set `callbackAddr` to 0.

Return codes

```
NoError
ErrorInvalidCardNumber
ErrorCardNotRegistered
ErrorFuncNotSupport
```

DIO_INT1_EventMessage

Controls the INT1 interrupt sources for a dual-interrupt system and notifies the application when an interrupt event occurs. Notification is implemented through a user-specified callback function or the Windows `PostMessage` API.

Syntax

C/C++ and Borland C++

```
I16 DIO_INT1_EventMessage (I16 Int1Mode, HANDLE
    windowHandle, U32 message, void
    *callbackAddr())
```

Visual Basic

```
DIO_INT1_EventMessage (ByVal Int1Mode As Integer,
    ByVal windowHandle As Long, ByVal message As
    Long, ByVal callbackAddr As Long) As Integer
```

Parameter(s)

Int1Mode

Interrupt mode of INT1.

Valid values include: MXC-6400, INT1_DISABLE, INT1_EXT_SIGNAL INT1 by COS of Ch0 of Port 0

windowHandle

Handle to the destination window for a Windows message when the specified INT event occurs. If `windowHandle` is 0, no Windows messages will be sent.

message

User-defined message. When the specified INT event occurs, MXC-6400 matrix_dio remits this message. The message can be of any value. In Windows, the message can be set to a value including any Windows predefined messages, such as WM_PAINT. However, to define a designated message, any value ranging from WM_USER (0x400) to 0x7fff can be used. This range is reserved by Windows for user-defined messages.

callbackAddr

Address of the user callback function. The MXC-6400 matrix_dio calls this function when the specified INT event occurs. If no callback function is desired, set callbackAddr to 0.

Return codes

```
NoError  
ErrorInvalidCardNumber  
ErrorCardNotRegistered  
ErrorFuncNotSupport
```

DIO_INT2_EventMessage

Controls INT2 interrupt sources for a dual-interrupt system and notifies the application when an interrupt event occurs. The notification is performed through a user-specified callback function or the Windows PostMessage API.

Syntax

C/C++ and Borland C++

```
I16 DIO_INT2_EventMessage (I16 Int2Mode, HANDLE  
    windowHandle, U32 message, void  
    *callbackAddr())
```

Visual Basic

```
DIO_INT2_EventMessage (ByVal Int2Mode As Integer,  
    ByVal windowHandle As Long, ByVal message As  
    Long, ByVal callbackAddr As Long) As Integer
```

Parameter(s)

Int2Mode

INT2 interrupt mode. Valid values include: MXC-6400, INT2_DISABLE, and INT2_EXT_SIGNAL INT2 by COS of Ch1 of Port 0

windowHandle

Handle to the destination window for a Windows message when the specified INT event occurs. If windowHandle is 0, no Windows messages will be sent.

message

User-defined message. When the specified INT event occurs, MXC-6400 matrix_dio remits this message. The message can be of any value. In Windows, the message can be set to a value including any Windows predefined messages, such as WM_PAINT. However, to define a designated message, any value ranging from WM_USER (0x400) to 0x7fff can be used. This range is reserved by Windows for user-defined messages.

callbackAddr

Address of the user callback function. The MXC-6400 matrix_dio calls this function when the specified INT event occurs. If no callback function is desired, set callbackAddr to 0.

Return codes

```
NoError
ErrorInvalidCardNumber
ErrorCardNotRegistered
ErrorFuncNotSupport
```

DIO_ SetDualInterrupt

Informs the MXC-6400 matrix_dio library of the two interrupt source modes of a dual-interrupt system and returns dual interrupt events. If an interrupt is generated, the corresponding interrupt event is signaled. The application uses Win32 wait functions, such as WaitForSingleObject or WaitForMultipleObjects to determine interrupt event status.

Syntax

C/C++ and Borland C++

```
I16 DIO_SetDualInterrupt (I16 Int1Mode, I16
    Int2Mode, HANDLE *hEvent)
```

Visual Basic

```
DIO_SetDualInterrupt (ByVal Int1Mode As Integer,  
    ByVal Int2Mode As Integer, hEvent As Long)  
    As Integer
```

Parameter(s)

CardNumber

ID of the card performing the operation.

Int1Mode

Interrupt mode of INT1.

Valid values include: MXC-6400, and INT1_DISABLE, INT1_EXT_SIGNAL INT1 by COS of Ch0 of Port 0

Int2Mode

Interrupt mode of INT2.

Valid values include: MXC-6400, and INT2_DISABLE, INT2_EXT_SIGNAL INT2 by COS of Ch1 of Port 0

hEvent

Returned dual-interrupt event handles, where status of a dual-interrupt event indicates whether an interrupt is generated for cards comprising dual-interrupt systems

Return codes

```
NoError  
ErrorInvalidCardNumber  
ErrorCardNotRegistered  
ErrorFuncNotSupport
```

Important Safety Instructions

For user safety, please read and follow all instructions, Warnings, Cautions, and Notes marked in this manual and on the associated device before handling/operating the device, to avoid injury or damage.

S'il vous plaît prêter attention stricte à tous les avertissements et mises en garde figurant sur l'appareil , pour éviter des blessures ou des dommages.

- ▶ Read these safety instructions carefully
- ▶ Keep the User's Manual for future reference
- ▶ Read the Specifications section of this manual for detailed information on the recommended operating environment
- ▶ The device can be operated at an ambient temperature of 50°C
- ▶ When installing/mounting or uninstalling/removing device; or when removal of a chassis cover is required for user servicing (See "Getting Started" on page 35.):
 - ▷ Turn off power and unplug any power cords/cables
 - ▷ Reinstall all chassis covers before restoring power
- ▶ To avoid electrical shock and/or damage to device:
 - ▷ Keep device away from water or liquid sources
 - ▷ Keep device away from high heat or humidity
 - ▷ Keep device properly ventilated (do not block or cover ventilation openings)
 - ▷ Always use recommended voltage and power source settings
 - ▷ Always install and operate device near an easily accessible electrical outlet
 - ▷ Secure the power cord (do not place any object on/over the power cord)
 - ▷ Only install/attach and operate device on stable surfaces and/or recommended mountings
- ▶ If the device will not be used for long periods of time, turn off and unplug from its power source

- ▶ Never attempt to repair the device, which should only be serviced by qualified technical personnel using suitable tools
- ▶ A Lithium-type battery may be provided for uninterrupted backup or emergency power.



Risk of explosion if battery is replaced with one of an incorrect type; please dispose of used batteries appropriately.

Risque d'explosion si la pile est remplacée par une autre de type incorrect. Veuillez jeter les piles usagées de façon appropriée.

- ▶ The device must be serviced by authorized technicians when:
 - ▷ The power cord or plug is damaged
 - ▷ Liquid has entered the device interior
 - ▷ The device has been exposed to high humidity and/or moisture
 - ▷ The device is not functioning or does not function according to the User's Manual
 - ▷ The device has been dropped and/or damaged and/or shows obvious signs of breakage
- ▶ Disconnect the power supply cord before loosening the thumbscrews and always fasten the thumbscrews with a screwdriver before starting the system up
- ▶ It is recommended that the device be installed only in a server room or computer room where access is:
 - ▷ Restricted to qualified service personnel or users familiar with restrictions applied to the location, reasons therefor, and any precautions required
 - ▷ Only afforded by the use of a tool or lock and key, or other means of security, and controlled by the authority responsible for the location

	<p>BURN HAZARD</p> <p>Touching this surface could result in bodily injury. To reduce risk, allow the surface to cool before touching.</p> <p><i>RISQUE DE BRÛLURES</i></p> <p><i>Ne touchez pas cette surface, cela pourrait entraîner des blessures.</i></p> <p><i>Pour éviter tout danger, laissez la surface refroidir avant de la toucher.</i></p>
---	--

This page intentionally left blank.

Getting Service

Ask an Expert: <http://askanexpert.adlinktech.com>

ADLINK Technology, Inc.

Address: 9F, No.166 Jian Yi Road, Zhonghe District
New Taipei City 235, Taiwan
新北市中和區建一路 166 號 9 樓
Tel: +886-2-8226-5877
Fax: +886-2-8226-5717
Email: service@adlinktech.com

Ampro ADLINK Technology, Inc.

Address: 5215 Hellyer Avenue, #110
San Jose, CA 95138, USA
Tel: +1-408-360-0200
Toll Free: +1-800-966-5200 (USA only)
Fax: +1-408-360-0222
Email: info@adlinktech.com

ADLINK Technology (China) Co., Ltd.

Address: 上海市浦东新区张江高科技园区芳春路 300 号 (201203)
300 Fang Chun Rd., Zhangjiang Hi-Tech Park
Pudong New Area, Shanghai, 201203 China
Tel: +86-21-5132-8988
Fax: +86-21-5132-3588
Email: market@adlinktech.com

ADLINK Technology Beijing

Address: 北京市海淀区上地东路 1 号盈创动力大厦 E 座 801 室(100085)
Rm. 801, Power Creative E, No. 1 Shang Di East Rd.
Beijing, 100085 China
Tel: +86-10-5885-8666
Fax: +86-10-5885-8626
Email: market@adlinktech.com

ADLINK Technology Shenzhen

Address: 深圳市南山区科技园南区高新南七道 数字技术园
A1 栋 2 楼 C 区 (518057)
2F, C Block, Bldg. A1, Cyber-Tech Zone, Gao Xin Ave. Sec. 7
High-Tech Industrial Park S., Shenzhen, 518054 China
Tel: +86-755-2643-4858
Fax: +86-755-2664-6353
Email: market@adlinktech.com

LiPPERT ADLINK Technology GmbH

Address: Hans-Thoma-Strasse 11
D-68163 Mannheim, Germany
Tel: +49-621-43214-0
Fax: +49-621 43214-30
Email: emea@adlinktech.com

PENTA ADLINK Technology GmbH

Ulrichsbergerstrasse 17
94469 Deggendorf, Germany
Tel: +49 (0) 991 290 94 – 10
Fax: +49 (0) 991 290 94 - 29
Email: emea@adlinktech.com

ADLINK Technology, Inc. (French Liaison Office)

Address: 6 allée de Londres, Immeuble Ceylan
91940 Les Ulis, France
Tel: +33 (0) 1 60 12 35 66
Fax: +33 (0) 1 60 12 35 66
Email: france@adlinktech.com

ADLINK Technology Japan Corporation

Address: 〒101-0045 東京都千代田区神田鍛冶町 3-7-4
神田 374 ヒル 4F
KANDA374 Bldg. 4F, 3-7-4 Kanda Kajicho,
Chiyoda-ku, Tokyo 101-0045, Japan
Tel: +81-3-4455-3722
Fax: +81-3-5209-6013
Email: japan@adlinktech.com

ADLINK Technology, Inc. (Korean Liaison Office)

Address: 경기도 성남시 분당구 수내로 46 번길 4 경동빌딩 2 층
(수내동 4-4 번지) (우) 463-825
2F, Kyungdong B/D, 4 Sunae-ro 46 beon-gil
Bundang-gu, Seongnam-si, Gyeonggi-do, Korea, 463-825
Toll Free +82-80-800-0585
Tel: +82-31-786-0585
Fax: +82-31-786-0583
Email: korea@adlinktech.com

ADLINK Technology Singapore Pte. Ltd.

Address: 84 Genting Lane #07-02A, Cityneon Design Centre
Singapore 349584
Tel: +65-6844-2261
Fax: +65-6844-2263
Email: singapore@adlinktech.com

ADLINK Technology Singapore Pte. Ltd. (Indian Liaison Office)

Address: #50-56, First Floor, Spearhead Towers
Margosa Main Road (between 16th/17th Cross)
Malleswaram, Bangalore - 560 055, India
Tel: +91-80-65605817, +91-80-42246107
Fax: +91-80-23464606
Email: india@adlinktech.com

ADLINK Technology, Inc. (Israeli Liaison Office)

Address: 27 Maskit St., Corex Building
PO Box 12777
Herzliya 4673300, Israel
Tel: +972-54-632-5251
Fax: +972-77-208-0230
Email: israel@adlinktech.com

ADLINK Technology, Inc. (UK Liaison Office)

Tel: +44 774 010 59 65
Email: UK@adlinktech.com