

# Regulator Numbering System

   = "Most Popular"

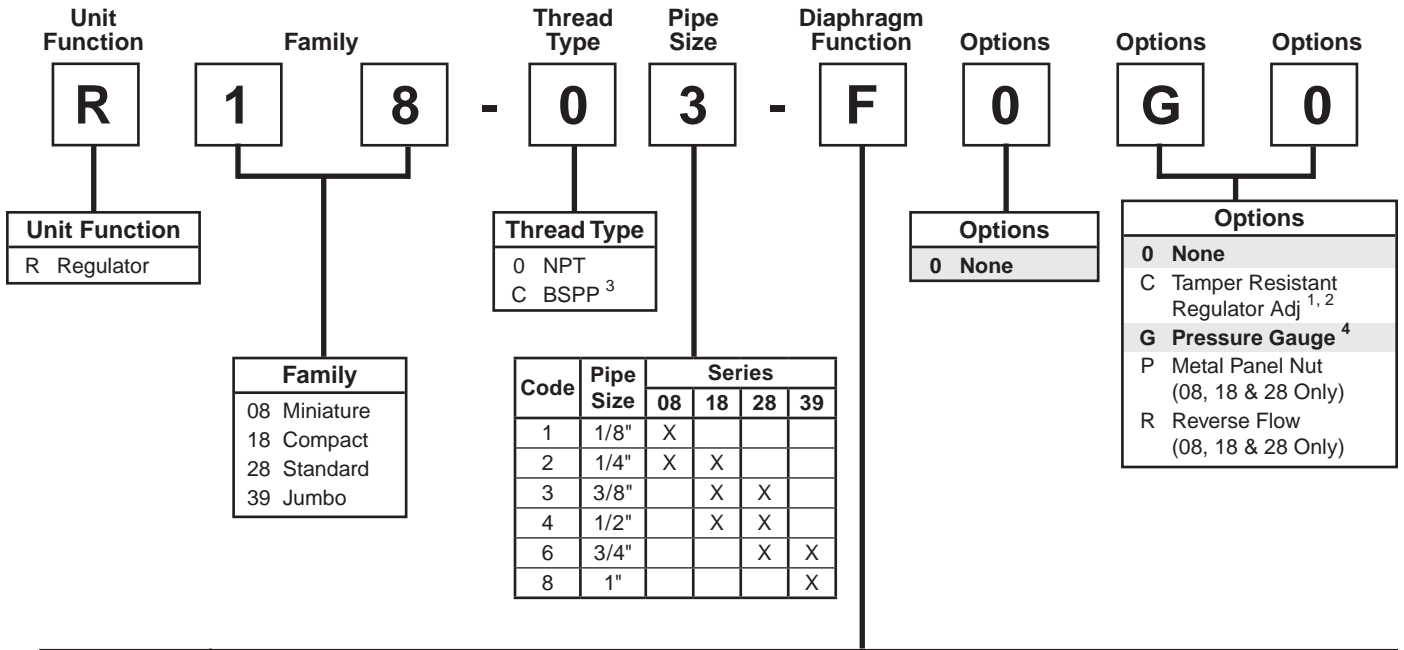

**B**  
Filters, Regulators, Lubricators

Diaphragm Function <sup>5</sup>	Fluorocarbon <sup>1</sup>	Spring Range				
		0 to 30 PSIG <sup>1</sup> (0 to 2.1 bar)	0 to 60 PSIG <sup>1</sup> (0 to 4.1 bar)	0 to 125 PSIG (0 to 8.6 bar)	0 to 200 PSIG <sup>1,6</sup> (0 to 13.7 bar)	0 to 250 PSIG <sup>1,6</sup> (0 to 17.2 bar)
Relieving	No	C	D	F	H	G
	Yes	J	K	L	N	M
Non-relieving	No	P	W	R	T	S
	Yes	V	X	Y	U	Z

<sup>1</sup> Not Available on 39 Series.  
<sup>2</sup> Tamper kit not installed. Kit is shipped loose in carton, for 08, 18 & 28 NPT units.  
<sup>3</sup> ISO, R228 (G Series).  
<sup>4</sup> For 08 Series only: "G" in position 8 or 9 is for unit with flush mounted pressure gauge. Units without gauge have 1/8" threaded gauge ports, and a center back mounted pressure gauge must be ordered separately.  
<sup>5</sup> 39 Series is piston type.  
<sup>6</sup> Not Available on 08 Series.

**NOTE:** When selecting from the options columns, please enter letters in alphabetical order for positions 7, 8, and 9.  
**For example:**

**R 1 8 - 0 3 - F 0 G 0**

# Regulator

## R18

= "Most Popular"

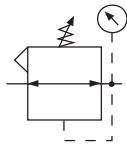

Relieving

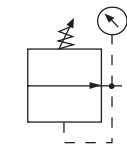

Non-Relieving



**R18-02-F0G0**

### Features

- Balanced Valve Design
- Spring-loaded Diaphragm
- 4 Adjusting Pressure Ranges Available
- 1/2" NPT / BSPP-G Over-port
- Reverse-flow Available
- 2 Gauge Ports

### Specifications

Flow Capacity*	1/4	82 SCFM (38.7 dm <sup>3</sup> /s)
	3/8	97 SCFM (45.7 dm <sup>3</sup> /s)
	1/2	97 SCFM (45.7 dm <sup>3</sup> /s)
Adjusting Range Pressure	0 to 30 PSIG (0 to 2.1 bar)	
	0 to 60 PSIG (0 to 4.1 bar)	
	0 to 125 PSIG (0 to 8.6 bar)	
	0 to 250 PSIG (0 to 17.2 bar)	

Gauge Port (2 ea.)	NPT / BSPP-G	1/4
Maximum Supply Pressure	300 PSIG (20.7 bar)	
Operating Temperature	-13° to 150°F (-25° to 65.5°C)	
Port Size	NPT / BSPP-G	1/4, 3/8, 1/2
Weight	lb. (kg)	1.16 (0.5)

\* Inlet pressure 100 PSIG (6.9 bar). Secondary pressure 90 PSIG (6.2 bar).

### Materials of Construction

Adjustment Knob	Acetal
Body	Zinc
Body Cap	ABS
Bonnet	33% glass-filled nylon
Bottom Plug	33% Glass-filled Nylon
Diaphragm Assembly	Nitrile / Zinc
Valve Assembly	Brass / Nitrile
Panel Nut	Acetal
Seals	Nitrile
Springs	Main Regulating Valve: Steel, Stainless Steel

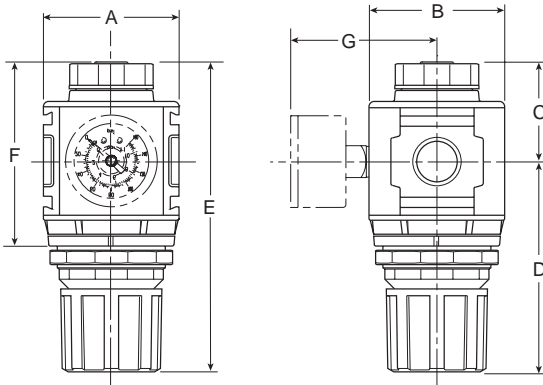

NOTE: 2" Dia. (51 mm) hole required for panel nut mounting.

### Dimensions

Models	Inches (mm)	A	B	C	D	E	F	G
Standard Unit R18-XX-F000		2.36 (60)	2.36 (60)	1.74 (44)	3.66 (93)	5.35 (136)	3.10 (78.7)	—
With Gauge R18-XX-F0G0		2.36 (60)	2.36 (60)	1.74 (44)	3.66 (93)	5.35 (136)	3.10 (78.7)	3.74 (94)

### WARNING

Product rupture can cause serious injury.  
Do not connect regulator to bottled gas.  
Do not exceed maximum primary pressure rating.

### CAUTION:

**REGULATOR PRESSURE ADJUSTMENT** – The working range of knob adjustment is designed to permit outlet pressures within their full range. Pressure adjustment beyond this range is also possible because the knob is not a limiting device. This is a common characteristic of most industrial regulators, and limiting devices may be obtained only by special design.

For best performance, regulated pressure should always be set by increasing the pressure up to the desired setting.

= "Most Popular"

### Replacement Kits

- Adjusting Knob..... RRP-16-340-000
- Diaphragm Assembly –
  - Non-relieving ..... RRP-96-657
  - Relieving..... RRP-96-656
- Spring, Regulating –
  - 0 to 30 PSIG (0 to 2.1 bar) ..... RRP-96-659
  - 0 to 60 PSIG (0 to 4.1 bar) ..... RRP-96-660
  - 0 to 125 PSIG (0 to 8.6 bar) ..... RRP-96-661
  - 0 to 250 PSIG (0 to 17.2 bar) ..... RRP-96-662
- Valve Assembly..... RRP-96-658

### Accessories

- Panel Mount Nut –
  - Aluminum..... RRP-96-673
  - Plastic..... RRP-96-675
- Pressure Gauge –
  - 0-30 PSIG, 1-1/2" Dial Face, 1/4 NPT CBM ..... K4515N14030
  - 0-60 PSIG, 1-1/2" Dial Face, 1/4 NPT CBM ..... K4515N14060
  - 0-160 PSIG, 1-1/2" Dial Face, 1/4 NPT CBM..... K4515N14160
  - 0-300 PSIG, 1-1/2" Dial Face, 1/4 NPT CBM .... K4515N14300
  - 0-2.0 bar, 1-1/2" Dial Face, G 1/4 CBM ..... K4515G14030
  - 0-4.1 bar, 1-1/2" Dial Face, G 1/4 CBM ..... K4515G14060
  - 0-11 bar, 1-1/2" Dial Face, G 1/4 CBM..... K4515G14160
  - 0-21 bar, 1-1/2" Dial Face, G 1/4 CBM ..... K4515G14290
- Tamper Resistant Kit..... RRP-96-671
- Wall Mounting Bracket –
  - L-Type ..... GPA-96-606
  - T-Type ..... GPA-96-602

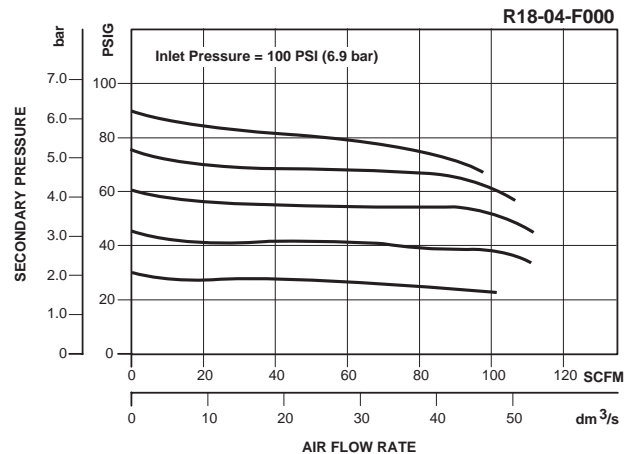
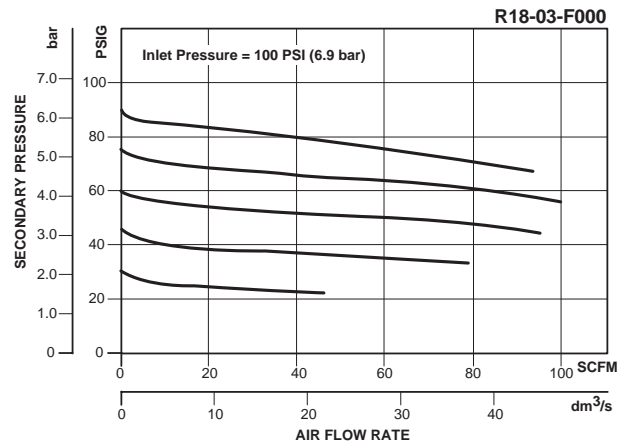
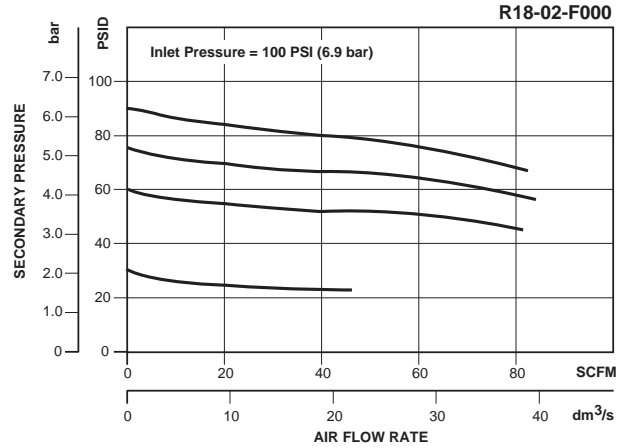

**B**  
Filters, Regulators, Lubricators

### Ordering Information

Model Type	Port Size	With Gauge 5 to 125 PSIG (0.4 to 8.6 bar)	With Gauge 10 to 250 PSIG (0.7 to 17.2 bar)	With Gauge 3 to 60 PSIG (0.2 to 4.1 bar)	Without Gauge 5 to 125 PSIG (0.4 to 8.6 bar)	Without Gauge 10 to 250 PSIG (0.7 to 17.2 bar)	Without Gauge 3 to 60 PSIG (0.2 to 4.1 bar)
Relieving	1/4	R18-02-F0G0	R18-02-G0G0	R18-02-D0G0	R18-02-F000	R18-02-G000	R18-02-D000
	3/8	R18-03-F0G0	R18-03-G0G0	R18-03-D0G0	R18-03-F000	R18-03-G000	R18-03-D000
	1/2	R18-04-F0G0	R18-04-G0G0	R18-04-D0G0	R18-04-F000	R18-04-G000	R18-04-D000
Non-relieving	1/4	R18-02-R0G0	R18-02-S0G0	R18-02-W0G0	R18-02-R000	R18-02-S000	R18-02-W000
	3/8	R18-03-R0G0	R18-03-S0G0	R18-03-W0G0	R18-03-R000	R18-03-S000	R18-03-W000
	1/2	R18-04-R0G0	R18-04-S0G0	R18-04-W0G0	R18-04-R000	R18-04-S000	R18-04-W000

**Options** - To order an option supplied with the unit model, add the appropriate coded suffix letter in the designated position of the model number.