



TS1 Series Temperature Controls Technical Data



Adjustable temperature controls for refrigeration applications.

Features

- Housing variants for top and front operation
- Flush mounted version
- Adjustable temperatures and differentials
- Range and differential pointer in units °C and °F
- Range and differential individually lockable by wire seal
- High rated SPDT contacts for all versions
- Captive terminal and cover screws
- Manual toggle for system checkout and override
- Vapour, liquid and x-ambient charges
- Sensor shapes for various applications
- Bellows heater for thermostats with vapour charge (not for frost monitors)
- Room thermostats with insulation console
- Versions with and without manual override

Options

- Gold plated contacts for electronic applications (PLC, low voltage/current)
- Factory set to customer specification
- Different types of mounting brackets
- Sensor bulb wells and capillary tube holders
- Special approvals

Introduction

The TS1 Series is ALCO's range of adjustable thermostats for application in refrigeration and heat pump systems.

In these systems, thermostats serve control and monitoring functions, such as space temperature control, high/low temperature alarming or defrost termination. By operating a set of electrical contacts, a temperature value is kept inside a certain limit.

Several housing variants and sensors are provided in order to suit a control to a specific application.

Housing variants

TS1 controls can be delivered in three main housing variants, top operated, front operated and flush mounted.

Top operated controls have adjustment spindles at the top and a display scale, indicating temperature setpoint and differential, at the front. A knob which may be permanently plugged onto one of the adjustment spindles comes with every control. Frost monitors and room thermostats are derivatives of top operated thermostats. They differ by their sensors and other features to suit their particular target applications.

Front operated controls have an adjustment knob at the front for the temperature setpoint with an approximate scale imprinted on



TS1 Top Operated



TS1 Front Operated



TS1 Flush Mounted

the knob. In order to adjust the temperature differential, the cover of the control must be removed.

Flush mounted controls are designed in a way that they can be integrated into a panel or housing, for example into display cases.

All of these three variants are available either with or without off-switch, which cuts off power supply to the thermostat in off position

Temperature sensing

TS1 thermostats sense temperature by means of a thermal system, consisting of temperature charge, bulb, capillary and bellows. The temperature charge changes its pressure based on the refrigerant temperature to be sensed. The sensor is the portion of the system which is in thermal contact with the refrigerant, the capillary connects the sensor with the bellows and the bellows contracts or expands depending on the temperature, causing the thermostat to operate the electrical contacts. An exception are capillary type of sensors, which do not have a bulb, instead, their capillary serves as the bulb directly.

Charges and sensor types are matched to temperature ranges and other application specific characteristics. TS1 thermostats come with one of three charge types: vapour charges, adsorption charges or liquid charges. The application temperature range covered by each charge type is shown below:

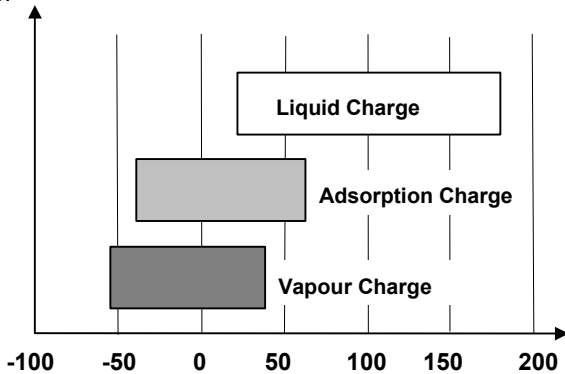

Vapour charge – Sensor type A, E, P

These sensing elements always sense from the coldest point on the capillary, coil, bulb or power element head. For proper operation it must be ensured that this coldest point is at the sensor portion which is exposed to the medium temperature to be sensed. The sensing location should be at least 2 K colder than the other parts of the thermal system.

In order to avoid unwanted effects of heat transfer, e.g. from a cold wall, ALCO vapour charged thermostats come with an integrated bellows heater (not for frost monitors), which is rated for 230 V applications. For other applications the heater must be disabled, alternatively, a bellows heater with a different rating may be available.

In addition to the bellows heater, room thermostats are supplied with an insulation console for the same reason.

Sensor type 'A' is a coiled bulb sensor with two meter capillary, which may be used with or without a bulb well. Style 'E' is a coil sensor for space temperature sensing, and type 'P' is a capillary type of sensor which can be wrapped around a heat exchanger's surface in order to sense the coldest point on the heat exchanger for frost protection applications.

Vapour charges respond faster to temperature changes than adsorption and liquid charges.

Adsorption charge – sensor type F

Adsorption charged sensor types operate on the basis of a temperature dependent adsorption material, which is located inside the bulb only. Therefore these sensor types always respond to temperature changes at the bulb only. This makes them suitable to applications where it is not always defined which part of the thermal system the coldest point is (cross ambient applications). An example for such applications is defrost control.

Adsorption charges are slower in response to temperature changes than vapour charges.

Liquid charge – sensor type C

Liquid charge sensors of type 'C' always sense from the warmest point of the thermal system. This condition must always be ensured. The sensing location should always be warmer than 2 K than other parts of the thermal system.

Setpoints

TS1 are adjustable controls with adjustment spindles for range and differential*. By turning the range spindle, the *upper setpoint* is defined and by adjusting the differential spindle, the differential and hence the *lower setpoint* is defined.

The dependency between upper and lower setpoint is always as follows:

$$\text{lower setpoint} = \text{upper setpoint} - \text{differential}$$

The following two rules should be kept in mind:

- an adjustment of the range spindle always affects both, upper and lower setpoint.
- an adjustment of the differential spindle affects the lower setpoint, only.

The following diagrams depict this dependency:

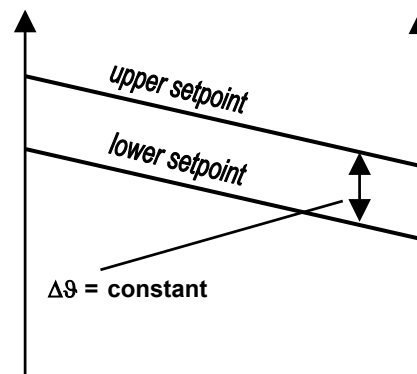

Effect of turning range spindle

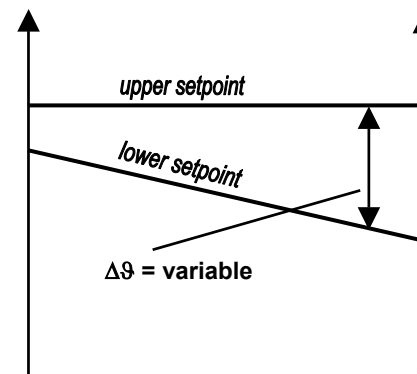

Effect of turning differential spindle

The controls are equipped with display scale and pointers to indicate the approximate settings. Top operated controls have display scales in units °C and °F, front operated controls have a display scale in units °C.

For precise setting of the controls, external thermometers must be used.

*) Manual reset controls and some other controls have a fixed differential and no differential spindle

Electrical contacts

TS1 temperature controls are equipped with high rated double snap action contacts for shatter-free and reliable operation.

All contacts throughout this range of controls are designed as Single Pole Double Throw (SPDT) contacts. One contact may be used for control and the other contact for alarm/status indication or auxilliary control.

Gold plated contacts are available on request for low electrical loads, for example in electronic signalling applications.

For applications using a supply voltage other than 230 V and for applications using gold plated contacts, the bellows heater of vapour charged thermostats (sensor style A, E or P – not for frost monitors function C or D) must be disabled.

Contact function

Thermostat contacts TS1 are labelled 1-2-4 where '1' refers to the common pole, '2' refers to the lower setpoint and '4' refers to the upper setpoint.

The contact function for automatic and manual reset versions is as described below.

Automatic reset

On temperature rise above the upper setpoint, contacts 1-2 open and contacts 1-4 close. On decreasing temperature lower setpoint contacts 1-4 open and contacts 1-2 close.

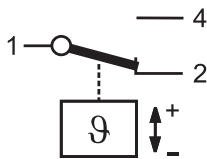

Automatic reset contact function

Manual reset low temperature

On decreasing temperature below the lower setpoint, contacts 1-4 open, contacts 1-2 close and latch. Only on pressure rise above upper setpoint and after pressing the manual reset button contacts 1-2 will open and contacts 1-4 will close again.

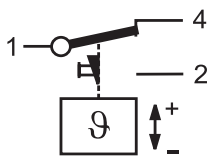

Manual reset low pressure contact function

Manual reset high temperature

On increasing temperature above the upper setpoint, contacts 1-2 open, contacts 1-4 close and latch. Only on falling temperature below lower setpoint and after pressing the manual reset button, contacts 1-4 will open and contacts 1-2 will close again.

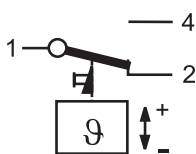

Manual reset high temperature contact function

For operational safety, all TS1 with manual reset are designed as *trip-free* controls, i.e. pressing the manual reset button while the temperature has not reached its reset threshold will not operate the electrical contacts.

Off-switch

TS1-B/F/H with an off-switch (TS1-B/F/H) cut off the line to terminal 1 when in Position "STOP".

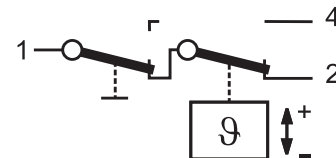

Off-switch interrupting line to terminal 1

Bellows heater

TS1 with vapour charges, ie. sensor types A, E, P (not frost monitors function C or D) have a bellows heater wired across the contacts in the following way.

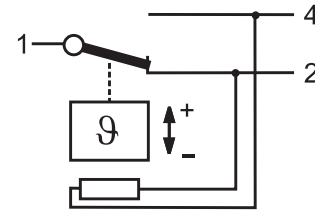

Bellows heater

Installation and maintenance

Controls come with an adjustment knob and a lockplate which may be used to protect the settings by wire-seal if desired. Range and differential spindle may be sealed independent from each other.

A front access manual toggle is provided for checking out control operation. All TS1 controls come with heavy duty terminal blocks which are finger-proof and feature wire clamps plus non-loosable terminal screws for ease of wiring.

Available accessories include mounting brackets of various types, sensor bulb wells and capillary tube holders.

The standard mounting holes for mounting brackets are equipped with a universal thread to fit both, M4 and UNC 8-32 screws. The standard wholesale package includes two mounting screws.

In addition, further hole patterns for surface mounting are provided.

Nomenclature

The following chart explains the nomenclature of the TS1 controls for ease of reference. The basic structure is that of a three digit *Product Name* followed by a three digit code, describing *Function*, *Temperature Range* and *Temperature Sensor*.

Customised versions, which deviate from standard catalogue products are available on request and use a different *Product Name*. They are called *TSA* followed by the three digit code to indicate *function*, *temperature range* and *temperature sensor*.

Type code

TS1 -



Product Name

TS1 = Adjustable thermostat
TSA = Customised version

Function / housing variant

A = Wall mounting, top adjustment
B = Wall mounting, top adjustment, off-switch
C = Frost monitor, auto reset
D = Frost monitor, manual reset
E = Wall mounting, front adjustment
F = Wall mounting, front adjustment, off-switch
G = Flush mounting
H = Flush mounting, off-switch
R = Wall mounting, top adjustment, manual reset*

*temp. ranges 0 – 4: manual reset for falling temperature
temp. ranges 5 – 9: manual reset for rising temperature

Temperature Sensor Type

A = Vapour charge, 2 m, bulb
C = Liquid charge, 2 m, bulb
E = Vapour charge, 0 m, coil
F = Adsorption charge, 2 m, bulb
P = Vapour charge, 2 m, capillary
function „C“ and „D“: 6 m capillary

Temperature range

0 = +4.5 ... +20 °C
1 = -45 ... -10 °C
2 = -30 ... +15 °C (-30 ... +10 °C)
3 = -10 ... +35 °C (-10 ... +25 °C)
4 = -25 ... +30 °C (-30 ... +35 °C)
5 = +20 ... +60 °C (+25 ... +75 °C)
6 = +50 ... +100 °C
7 = 0 ... +10 °C
() = dep. on exact version

Technical data

Environmental conditions

Ambient temperatures storage and transportation:	-50 °C to +70 °C
operation:	-50 °C to +70 °C
Maximum temperature at sensor bulb	depending on bulb type and charge
Dust and water protection EN 60529 / IEC 529:	IP44 (w/o off-switch) IP30 (with off-switch)
Control mounted flush against wall!	
Vibration resistance:	4 g @ 10 ... 1000 Hz

Approvals

Low Voltage Directive 73/23/EWG 93/68/EWG; EN 60947-1 / 60947-5-1 / 60730-2-9	all models (CE-Label)
Germanic Lloyd:	standard models when used with marine cable glands (accessory)
UL / CSA:	all models (<i>pending</i>)

Electrical contacts

Type of contacts	1 x SPDT contact
Contact material	- standard: CuAg3 - options: gold plated contacts
Heating load (AC1):	24 A / 230 V AC
Inductive load (AC15):	10 A / 230 V AC
Inductive load (DC 13):	0.1 A / 230 V DC 3 A / 24 V DC 6 A / 12 V DC
Motor rating UL (FLA):	24 V AC
Locked rotor UL (LRA)/Startup (AC3):	144 A / 230 V AC
Bellows heater (sensor types A, E, P - not for frost monitors function C or D):	82 kΩ, 230 V AC, DC - option: 12 V, 24 V rating

Materials

Housing materials	cover: Polycarbonate (PC) frame: Steel, yellow chromated
-------------------	---

Physical dimensions and drawings

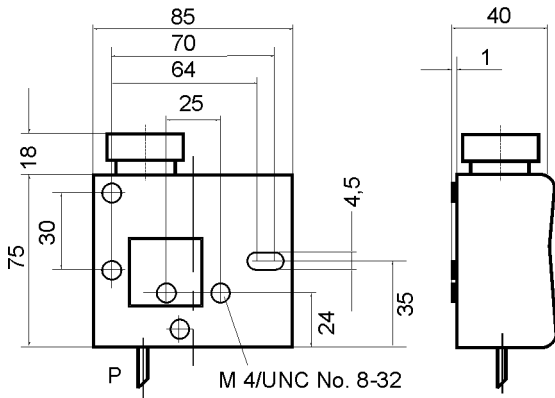

TS1-A / B / C / D

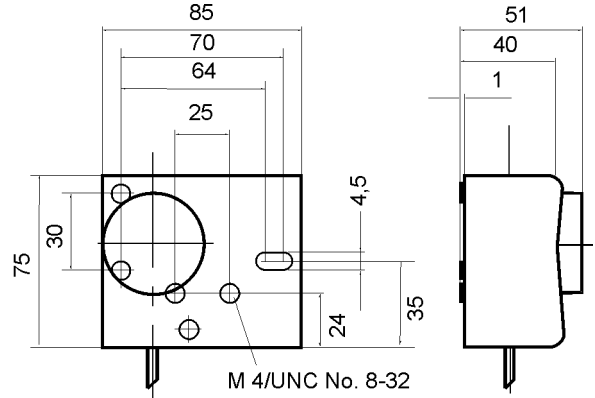

TS1-E / F

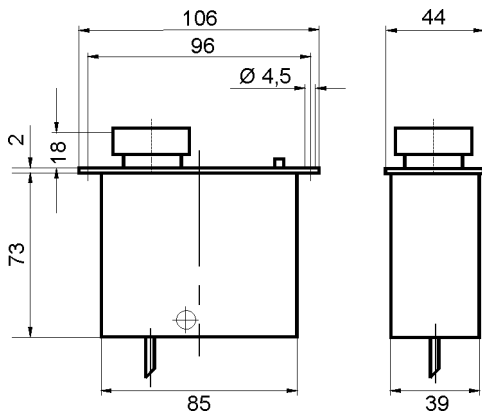

TS1-G / H

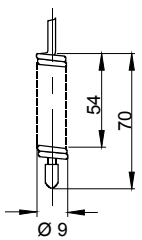

Sensor type A
Vapour charge
2 m capillary
with bulb

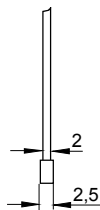

Sensor type P
Vapour charge
2 m capillary
(6m with function C
or D)

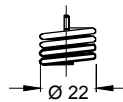

Sensor type E
Vapour charge
coil, 0 m

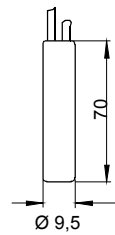

Sensor type F
Adsorption charge
2 m capillary
with bulb

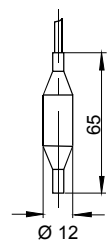

Sensor type C
Liquid charge
2 m capillary
with bulb



TS1 Series Temperature Controls



Standard Temperature Controls

Temperature controls should be selected such, that the target upper and lower setpoints fall well inside the adjustment range and not at the end of the specified range.

Type	PCN	Adjustment Upper Setpoint °C	Range Differential Setpoint K	Lowest Setpoint °C	Factory Setting °C	Max. Bulb Temp. °C	Temp. Sensor Charge	Sensor Type
Thermostats TS1 Top Operated (with capillary type sensor)								
Thermostats without Off-Switch								
TS1-A2P	4 530 400	-30 ... +15	1.5 ... 16	-36	-1 / -6	+150	Vapour	2 m capillary
TS1-R2P <i>Low temp cut out</i>	4 715 170	-30 ... +15	man. reset ca. 2.5 fix	-32	+2			
TS1-A3P	4 356 700	-10 ... +35	1.5 ... 16	-23	+3 / -2			
TS1-A1A	4 351 500	-45 ... -10	1.5 ... 16	-55	-18 / -20	+150	Vapour	2 m cap. and bulb
TS1-A2A	4 351 600	-30 ... +15		-36	-1 / -6			
TS1-A3A	4 352 500	-10 ... +35		-23	+3 / -2			
TS1-A4F <i>Defrost- and Universal Thermostat</i>	4 351 800	-30 ... +35	2.8 ... 20	-35	+5 / 0	+100	Adsorption	2 m capillary and bulb
TS1-A5F	4 458 400	+20 ... +60	3 ... 10	+10	+35 / +30			
TS1-A5C	4 351 900	+25 ... +75	2 ... 15	+20	+65 / +60	+100	Liquid	
TS1-A6C	4 352 000	+50 ... +100	2 ... 15	+47	+85 / +80	+125		
TS1-A8C	4 354 900	+90 ... +140	3 ... 20	+87	+100 / +95	+160		
TS1-A9C	4 355 000	+130 ... +180	3 ... 20	+127	+160 / +155	+210		
Thermostats with Off-Switch								
TS1-B1A	4 366 700	-45 ... -10	1.5 ... 16	-55	-18 / -20	+150	Vapour	2 m capillary and bulb
TS1-B2A	4 366 800	-30 ... +15		-36	-1 / -6			
TS1-B3A	4 366 900	-10 ... +35		-23	+3 / -2			
TS1-B4F	4 367 000	-30 ... +35	2.8 ... 20	-35	+5 / 0	+100	Adsorption	
Room Thermostats TS1 Top Operated (with coil type sensor)								
Room Thermostats without Off-Switch, including insulation console								
TS1-A1E	4 362 800	-45 ... -10	1.5 ... 16	-55	-18 / -20	+70	Vapour	0 m coil
TS1-A2E	4 355 200	-30 ... +15		-36	+4 / +2			
TS1-A3E	4 355 300	-10 ... +35		-23	+20 / +18			
Room Thermostats with Off-Switch, including insulation console								
TS1-B1E	4 344 300	-45 ... -10	1.5 ... 16	-55	-18 / -20	+70	Vapour	0 m coil
TS1-B2E	4 344 400	-30 ... +15		-36	+4 / +2			
TS1-B3E	4 344 500	-10 ... +35		-23	+20 / +18			
Frost Monitors TS1 Top Operated (with capillary type sensor)								
Frost Monitors without Off-Switch								
TS1-C0P	4 352 100	+4.5 ... +20	2.5 fix	+2	4.5 / +2	+150	Vapour	6 m capillary
TS1-D0P <i>Low temp. cut out</i>	4 352 200	+4.5 ... +20	man. reset ca. 2.5 fix	+2	+2			



TS1 Series Temperature Controls



Type	PCN	Adjustment Upper Setpoint °C	Range Differential Setpoint K	Lowest Setpoint °C	Factory Setting °C	Max. Bulb Temp. °C	Temp. Sensor Charge	Sensor Type
Thermostats TS1 Front Operated (with capillary type sensor)								
Thermostats without Off-Switch								
TS1-E1A	4 361 000	-45 ... -10	2 ... 16	-55	-18 / -20	+150	Vapour	2 m capillary and bulb
TS1-E2A	4 356 200	-30 ... +10	1.5 ... 15	-36	+4 / +2			
TS1-E3A	4 365 200	-10 ... +25	1.5 ... 15	-23	+3 / -2			
TS1-E4F <i>Defrost- and Universal Thermostat</i>	4 367 500	-25 ... +30	2.8 ... 20	-30	+5 / 0	+100	Adsorption	
TS1-E5F	4 338 100	+20 ... +60	3 ... 10	+10	+35 / +30			
TS1-E7F <i>Milk and beer Cooler Thermostat</i>	4 367 600	+0 ... +10	2.5 fix	-2.5	+5.5 / +3			
Thermostats with Off-Switch								
TS1-F1A	4 367 100	-45 ... -10	2 ... 16	-55	-18 / -20	+150	Vapour	2 m capillary and bulb
TS1-F2A	4 367 200	-30 ... +10	1.5 ... 15	-36	-1 / -6			
TS1-F3A	4 367 400	-10 ... +25	1.5 ... 15	-23	+3 / -2			
Room Thermostats TS1 Front Operated (with coil type sensor)								
Room Thermostats without Off-Switch, including insulation console								
TS1-E1E	4 365 300	-45 ... -10	2 ... 16	-55	-18 / -20	+70	Vapour	0 m coil
TS1-E2E	4 356 800	-30 ... +10	1.5 ... 15	-36	+4 / +2			
TS1-E3E	4 356 900	-10 ... +25	1.5 ... 15	-23	+20 / +18			
Room Thermostats with Off-Switch, including insulation console								
TS1-F1E	4 368 000	-45 ... -10	2 ... 16	-55	-18 / -20	+70	Vapour	0 m coil
TS1-F2E	4 368 100	-30 ... +10	1.5 ... 15	-36	+4 / +2			
TS1-F3E	4 368 200	-10 ... +25	1.5 ... 15	-23	+20 / +18			
TS1-F4E	4 465 000	0 ... +40	2 ... 16	-7	+20 / +18			
Thermostats TS1 for Flush Mounting (with coil type sensor)								
Thermostats for Flush Mounting without Off-Switch								
TS1-G1A	4 364 700	-45 ... -10	1.5 ... 15	-55	-18 / -20	+150	Vapour	2 m capillary and bulb
TS1-G2A	4 355 400	-30 ... +15	1.5 ... 15	-36	+4 / +2			
TS1-G3A	4 364 800	-10 ... +35	1.5 ... 15	-23	+20 / +18			
TS1-G4F <i>Defrost- and Universal Thermostat</i>	4 355 600	-30 ... +35	2.8 ... 20	-35	+5 / 0	+100	Adsorption	
TS1-G7F <i>Milk and beer Cooler Thermostat</i>	4 356 000	0 ... +10	2.5 fix	-2.5	+5.5 / +3			
Thermostats for Flush Mounting with Off-Switch								
TS1-H1A	4 364 600	-45 ... -10	1.5 ... 15	-55	-18 / -20	+150	Vapour	2 m capillary and bulb
TS1-H2A	4 355 500	-30 ... +15	1.5 ... 15	-36	-1 / -6			
TS1-H3A	4 367 900	-10 ... +35	1.5 ... 15	-23	+3 / +2			
TS1-H4F	4 355 800	-30 ... +35	2.8 ... 20	-35	+5 / 0	+100	Adsorption	
TS1-H7F <i>Milk and beer Cooler Thermostat</i>	4 365 500	0 ... +10	2.5 fix	-2.5	+5.5 / 3			

