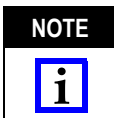

Figure 1

1. INTRODUCTION

This instruction sheet covers contact insertion and extraction procedures for AMPSEAL Automotive Plug Assemblies 776268-[], 776273-[], 770680-[], and 776164-[].



Dimensions in this instruction sheet are in metric units [with U.S. customary units in brackets]. Figures are not drawn to scale.

For information on contact crimping and mating header assemblies, refer to the instruction sheet packaged with the product.

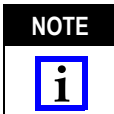

*Instruction sheet packaged with product is:
408-3284 — AMPSEAL Automotive Contacts 770520-[]
408-3285 — AMPSEAL Automotive Header Assemblies 770669-[]*

Reasons for reissue of this instruction sheet are provided in Section 5, REVISION SUMMARY.

2. DESCRIPTION

The plug assembly consists of a housing with contact cavities, cover, red wedge lock, wire seals, and mating seal. See Figure 1.

Each contact cavity contains a wire seal that protects the contact cavity from contaminants. During contact insertion, the wire seal is pierced as the contact passes through the contact cavity. Empty contact cavities will remain sealed. The mating seal provides a tight closure for mated connectors. The red wedge lock is used to lock fully seated contacts in the housing.

3. ASSEMBLY PROCEDURE



NEVER remove the red wedge lock from the housing.

3.1. Contact Insertion

1. Ensure that the contacts are properly crimped.
2. Check that the red wedge lock of the plug assembly is in the open position. If it is not in the open position, refer to Step 1 of Paragraph 3.2.

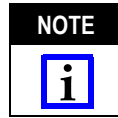

The plug assembly is supplied with the red wedge lock in the open position. DO NOT attempt to insert any contacts with the red wedge lock in the closed position.

3. From the wire size of the plug assembly, align the contact with the applicable contact cavity, then insert the contact until there is an audible or tactile click. Refer to Figure 2. DO NOT force the contact. If the contact is difficult to insert, check that the red wedge lock is fully open.

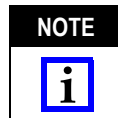

If an empty contact cavity is inadvertently pierced, insert Seal Plug 770678-1, large end first, into the contact cavity as far as it will go to re-seal it.

4. Pull wire slightly (force between 4 and 9 N [1 and 2 in.-lbs]) to ensure that the contact has engaged the retention fingers of the contact cavity. See Figure 2.

Inserting Contact

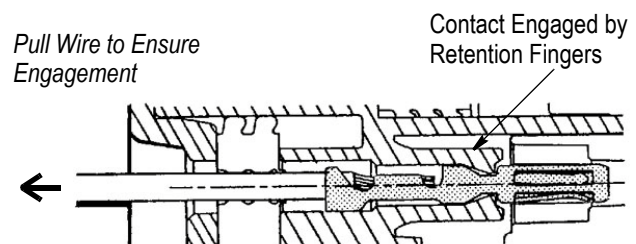
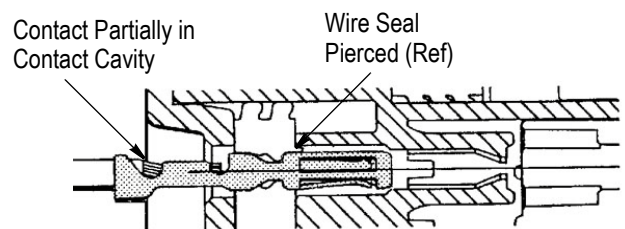

Figure 2

5. After all contacts have been inserted, close the red wedge lock by simultaneously squeezing the locking latches inward, and pushing the red wedge lock into the housing until it is flush with the edge of the housing. See Figure 3.

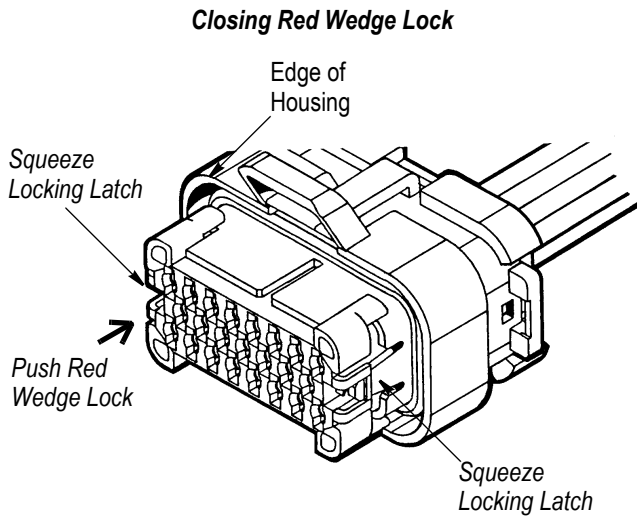

Figure 3

3.2. Contact Removal

1. Move the red wedge lock to the open position as follows:

a. Insert the tip of a screwdriver having a blade between 2 and 5 mm [.078 and .196 in.] wide between the edge of the plug assembly housing and one corner of the red wedge lock. See Figure 4.

b. Gently pry the edge of the red wedge lock until it is released from (but not completely out of) the housing.



Be careful not to break any part of the assembly when releasing the red wedge lock.

c. Repeat these steps for the opposite corner of the red wedge lock. The red wedge lock is now in the open position.

2. Gently pull the wire of the contact to be removed while rotating the wire (a quarter turn each direction) back and forth until the contact is removed from the housing. See Figure 5.

Opening Red Wedge Lock

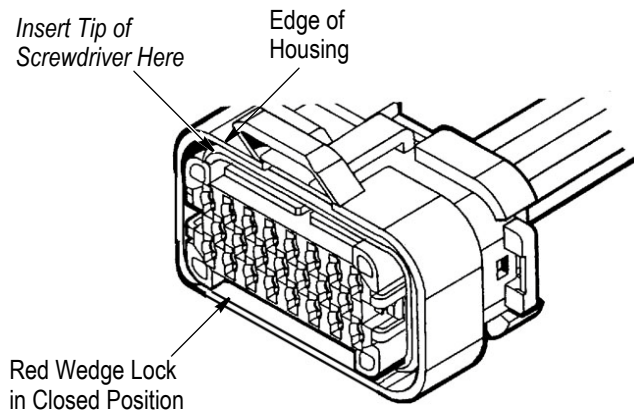

Figure 4

Removing Contact

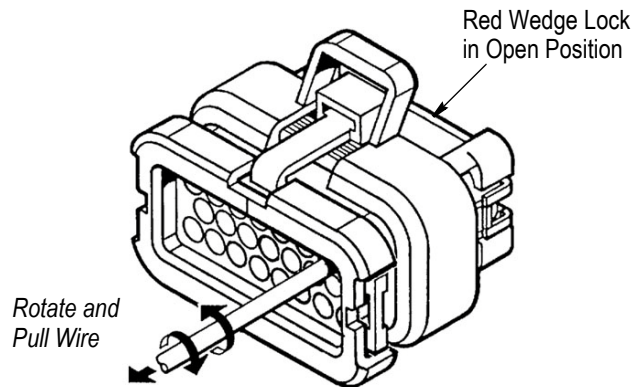

Figure 5

4. REPLACEMENT AND REPAIR

The contacts and plug assemblies are not repairable. Discard and replace any defective or damaged contacts or plug assemblies. DO NOT re-use a terminated contact by removing the wire.

5. REVISION SUMMARY

Revisions to this instruction sheet include:

- Changed company logo