



Totally Focused. Totally Independent.

Technical Guide

ECP32-2M/4C

C-TYPE



The world's largest
independent producer of
alternators 1 – 5,000kVA

Standards

Alternators are designed and produced within an ISO 9001 environment. The entire series is manufactured according to, and complies with, the most common specifications such as CEI 2-3, IEC 34-1, EN 60034-1, VDE 0530, BS 4999-5000, NF 51.111, CAN/CSA-C22.2 No14-95-No100-95, NEMA MG 1-2011, ISO 8528-3. Other standards such as UL1446, UL 1004/4 and /B are available on request.

Windings and Performances

All windings are 2/3rds pitch to eliminate triplen harmonics within the voltage waveform and to avoid excessive neutral currents in certain parallel operating conditions. A fully interconnected aluminium or copper damper cage is supplied on the rotor of all models (excluding the ECP3 series).

- ▶ 12 wire reconnectable:
 - 50Hz – 380V to 440V and 220/110V to 240/120V (de-rates may apply at certain voltages)
 - 60Hz – 380V to 480V and 220/110V to 240/120V (de-rates may apply at certain voltages)
- ▶ 6 wire reconnectable:
 - 50Hz – 380V to 440V and 220V to 240V (de-rates may apply at certain voltages)
 - 60Hz – 380V to 480V and 220V to 240V (de-rates may apply at certain voltages)

Winding Configurations	Standard		Special (dedicated)			
	12 wire Reconnectable	6 wire Reconnectable	380V and 600V 60Hz	690V 50/60Hz	220-240V 1ph 50Hz	220-240V 1ph 60Hz
ECP3 to ECO38	Std	Option	Option	Option	Option	Option
ECO40 to ECO46	Std	Option	Option	Option	Option (to ECO40)	Option (to ECO40)
Insulation materials	Class H	Class H	Class H	Class H	Class H	Class H
High efficiency	Std	Std	Std	Std	Std	Std
High motor starting	>300%	>300%	>300%	>300%	>300%	>300%
THD (Total Harmonic Distortion)	Typically <3.5% full load L-L	Typically <3.0% full load L-L	Typically <3.5% full load L-L	Typically <3.5% full load L-L	Typically <4.5% full load L-N	Typically <4.5% full load L-N
Interference suppression	VDE 0875 G/N/K, EN61000-6-3, EN61000-6-2, others available on request					

Winding Protection

There are various degrees of protection for the windings following the standard impregnation process, as can be seen here. The TOTAL+ butadienic black flexible coating is recommended for arduous applications.

Winding Protection:	STANDARD	STANDARD+	GREY	GREY+	TOTAL+ (3% de-rate may apply on certain models)
ECP3	Std	Option	Option	Option	Option
ECP28 and ECP32	-	Std	Option	Option	Option
NPE32, ECP34 to ECO46	-	-	Std	Option	Option

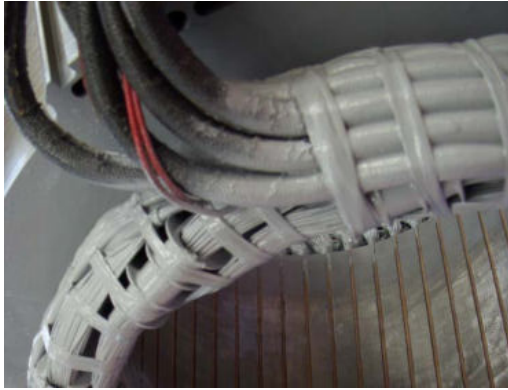

Grey treatment (marinization) on the left, TOTAL+ treatment shown on the right. The EG43 grey varnish, is an high temperature insulating enamel that forms a tough and flexible film, with excellent moisture and chemical protection. It is water and oil proof, and also protects windings from abrasion. It is applied spraying an over coating layer over the impregnated winding, or dipping the stator in a varnish barrel for superior treatments

The TOTAL+ is a protection system that makes Mecc Alte special. It is the ultimate winding treatment that offers truly superior performances when the environment is really harsh, or the application very demanding. It is a rubbery protection treatment, used to replace epoxies and silicones winding encapsulation. The TOTAL+ flexible black compound cures to a tough, resilient, glossy black thick coating that seals the copper against moisture and chemical attacks. Due to its encapsulation capability and flexibility, is also extremely resistant to the particle abrasion as it adsorbs the impacts. Moreover, the high flexibility leads to a long-trouble less life protection, as the compound follows elastically the thermal expansion cycles of the windings from the cold to the hot condition and vice versa without forming any cracks.

Protection for Environment

In addition to protection on the windings themselves, the alternators can have increased ingress protection. Standard levels are IP23 with further upgrades available to include inlet filters, IP43 and IP45: 7% de-rates apply on inlet filters and IP43 protection. 20-30% de-rates apply for IP45 depending on alternator model.

Additional air exit louvres (called IP23+) are optionably retrofittable in the overall ECP32 to ECO 46 range, in order to comply to the most strict marine regulations.



Construction

The robust mechanical structure withstands up to 5G in any direction and 9G vertically and its design permits easy access to the connections and components during routine maintenance check-ups. The mechanical design has used the most advanced FEM techniques. The materials used are: FEPI2 steel for the frame, C45 steel for the shaft and cast iron or aluminum pressure die cast for the end-brackets: fans are aluminum die casted either nylon fiber glass loaded, UL compliant materials. Rotors are dynamically balanced according grade 2.5 of ISO 1940-1.

Terminals and Terminal Box

Easy access to regulators is assured through a pull out drawer or a drop down panel to allow safer adjustment. Large terminal boxes allow easy access of power cables, in the ECO43 and ECO46 higher power ranges the terminal allow the convenient choice of power cable or busbar connection with versatility of entry and connection. Current transformers are available as an option on series ECO 40, 43 and 46 with single or dual output.

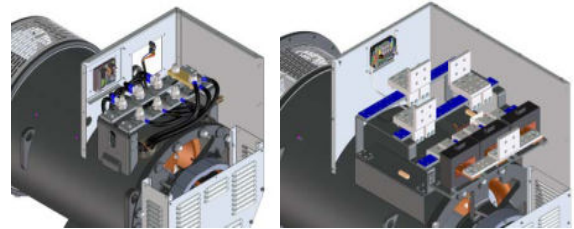

Excitation and Regulation Systems

All ECP/ECO series have MAUX auxiliary winding to power the digital regulator. Both DSR and the DER1 are available to connect to PC through the DxR2 USB interface and DxR TERMINAL software to interrogate/download alarms & settings for analysis or for cloning other regulators. DER2 has got an integrated USB connection and can be connected to the PC without any optional connection boards. More settings such as LAMS, digital RAM based synchronous external control and soft start are obtainable through the DxR connection. Simple analogue potentiometers are available for the more usual adjustments.

Excitation Systems	DSR	DER1	DER2
ECP3 to ECO38	Std	Option	Option
ECO40 to ECO46	-	Std	Option
Parallel Operation	√	√	√
Mains Parallel	√	√	√
3 Phase Sensing (rms)	-	√	√
Accuracy	+/-1%	+/-0.5%	+/-0.5%
Remote Voltage Control	√	√	√
Alarm Log	√	√	√
Analogue and Digital Configurable	√	√	√
LAMS (Load Acceptance V/f)	√	√	√
APO (Active Protection Output)	√	√	√
Soft Start	√	√	√
High dynamic response	-	-	√
USB connection without external boards	-	-	√

For a given motor start duty a smaller machine may be selected – also enhanced by low sub-transient reactance values for non-linear loads. The whole range from 6.5 to 3400kVA is capable of >300% sustained short circuit current for up to 20 seconds.

Optional PMG3

PMG3 can be retro fit or factory fit on ECO 40, 43 and 46 series. This smart MeccAlte design allows an easy fix kit, through a tapered cone coupling and a simple replacement of the rear air louvre. PMG3 is also available on ECO 38, when ordered from the factory.

The complete AVR range is fully compatible with both MAUX and PMG3 systems, this minimises spare part management and flexibility of stock as one AVR suits all applications. The PMG3 is delivering the same amount of kVA available with the MAUX.

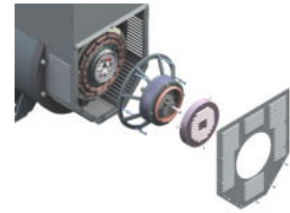

Accessories

Additional optionals can be fit on our alternator series, such as PTC thermistors or PT100 both on windings and bearings, space heaters, high and low profile of terminal boxes (on most series), air filter clogging sensors, rotating diode bridge failure sensor (RBD), power factor controller for parallel operation (PFR/2), parallel devices (standard from ECO 40), air filters, IP43 and IP45 protections, marine IP23 + protection for SOLAS requirements and many others.

Deration coefficients

Altitude (meters)	Ambient temperature (Celsius)					
	25	40	45	50	55	60
≤ 1000	1.07	1	0.96	0.93	0.91	0.89
$> 1000 \leq 1500$	1.01	0.96	0.92	0.89	0.87	0.84
$> 1500 \leq 2000$	0.96	0.91	0.87	0.84	0.83	0.79
$> 2000 \leq 3000$	0.9	0.85	0.81	0.78	0.76	0.73

Notes on short circuit curves

The indicated coefficients have to be used to correct the three phase short circuit curves values as a function of the rated voltage.

The indicated coefficient have to be used to correct the three phase short circuit curves values as a function of the type of short circuit voltage.

50 Hz		60 Hz	
Voltage	Factor	Voltage	Factor
380	0.93X	415	0.85X
400	1X	440	0.90X
415	1.04X	460	0.95X
440	1.10X	480	1X

	3 phase	2 phase L-L	1 phase L-N
<i>Istantaneous</i>	1X	0.87X	1.30X
<i>Minimum</i>	1X	1.80X	3.20X
<i>Sustained</i>	1X	1.50X	2.50X
<i>Max Duration</i>	20 sec.	10 sec.	4 sec.

All the curves are shown for series or parallel star connection at 400V 50 Hz or 480V 60 Hz. If the unit is reconnected from series to parallel star, the additional coefficient is 2X. From series star to series delta, it is 1.72X. From series star to parallel delta, it is 3.44X.

Allgemeine Charakteristiken

Anzahl der Pole	4	Isolationsklasse	H
Anzahl der Phasen	3	mech. Schutzklasse	IP23
Anzahl der Statorleitungen	12	NDE hinteres Lager B-Seite	6309-2RS
Ausführung	bürstenlos	DE vorderes Lager A-Seite	6312-2RS
Reglertyp	DSR	Maximale Überdrehzahl	2250
Wickelschritt	2/3	Aufstellhöhe	≤ 1000
Spannungsreferenz-Code	T0405S3	Balancing	ISO1940-1

Leistungen

400V - 50Hz @ 125/40°C - 0.8 PF - Standard		ECP32 2M4 C
Nennleistung	kVA	62,5
	kW	50

Widerstand & Zeitkonstanten

Ungesättigt (nach EN60034-4)			ECP32 2M4 C
X_d	Synchron-Längsreaktanz	%	276,3
X'_d	Transient-Längsreaktanz	%	13,8
X''_d	Subtransient-Längsreaktanz	%	8,1
X_q	Synchron-Querreaktanz	%	113,9
X'_q	Transient-Querreaktanz	%	113,9
X''_q	Subtransient-Querreaktanz	%	33,8
X₂	Invers-Widerstand	%	20,4
X₀	Nullreaktanz	%	3,21
Gesättigt			ECP32 2M4 C
X_d	Synchron-Längsreaktanz	%	234,9
X'_d	Transient-Längsreaktanz	%	11,7
X''_d	Subtransient-Längsreaktanz	%	6,88
X_q	Synchron-Querreaktanz	%	96,8
X'_q	Transient-Querreaktanz	%	96,8
X''_q	Subtransient-Querreaktanz	%	28,7
X₂	Invers-Widerstand	%	17,3
X₀	Nullreaktanz	%	3,21
K_{cc}	Kurzschlussverhältnis		0,43
T'_d	Transient-Kurzschlusszeitkonstante der Längsachse	sec	0,055
T''_d	Subtransient-Kurzschlusszeitkonstante der Längsachse	sec	0,011
T'_{do}	Transient-Leerlaufzeitkonstante der Längsachse	sec	1,1
T_a	Ankerzeitkonstante	sec	0,016

Zusatzinformationen

I_o	Erregerstrom bei Leerlauf	A	0,7
I_c	Erregerstrom bei Vollast	A	2,6
Überlast		1 Stunde mit 110% Nennlast innerhalb eines Zeitraums von 6 Stunden	
	Überlast für 20 sek.	%	300
	Wärmeableitung	W	5928
	Telephone Harmonic Faktor - THF	%	<2
	Klirrfaktor(THD) bei Vollast LL/LN	%	2,1 / 2,1
	Klirrfaktor(THD) bei Leerlauf LL/LN	%	2,7 / 2,7

Wirkungsgrade @ 50 Hz

Modell		400/230V 50Hz				
		0.25	0.5	0.75	1	1.1
ECP32 2M4 C	%	90,6	91,7	90,7	89,4	88,8

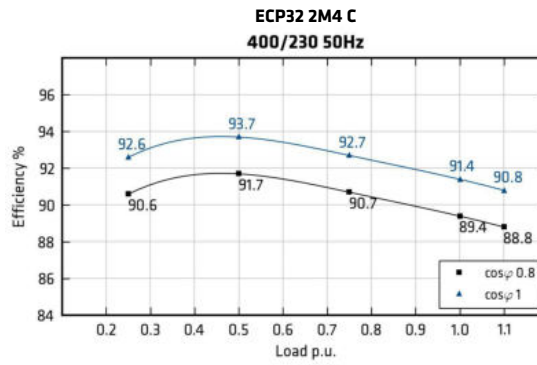

Überspannung

400V - 50Hz

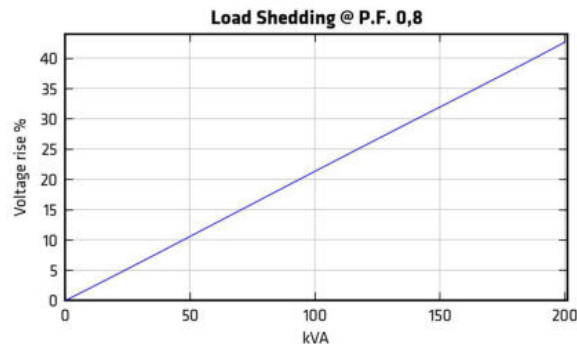
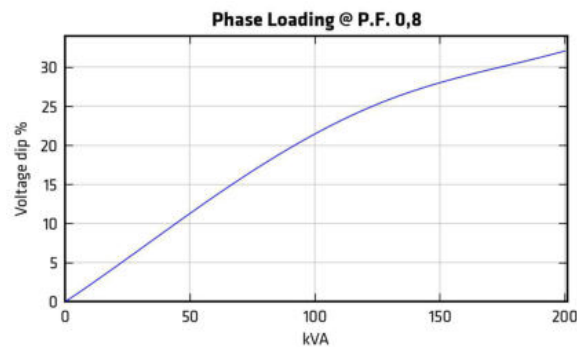
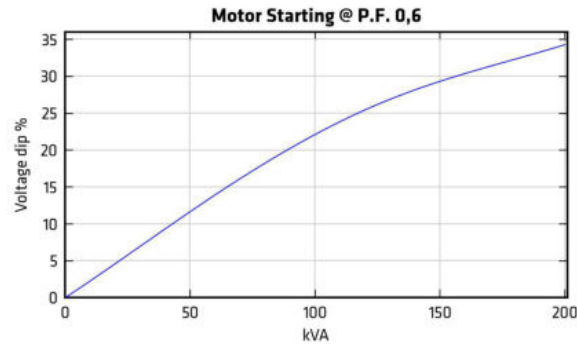

Um Einschwingkurven als eine Funktion eines Leistungsfaktors oder von Spannung zu skalieren, gehen Sie - falls nicht angegeben - bitte folgendermaßen vor:

Leistungsfaktorkorrekturkoeffizient (PFCC), zu verwenden bei Kurven mit einem Leistungsfaktor von 0,6:

$$PFCC = \sin(\text{ARCCos}(PF_{\text{new}})) / 0,8$$

Beispiel: Der PFCC bei einem Leistungsfaktor von 0,3 beträgt 1,192 [$PFCC = \sin(\text{ARCCos}(0,3)) / 0,8$]. Das bedeutet, dass der Spannungsabfall bei einer gegebenen Leistung bei einem Leistungsfaktor (PF) von 0,3 demjenigen entspricht, der auf der Kurve mit einem PF von 0,6 abgelesen werden kann, wenn angenommen wird, dass die Last 1,192 Mal größer ist (19 % höherer Wert). Bei diesem Beispiel entspricht ein Lasteinsatz von 100 kVA bei einem PF von 0,3 einem Spannungsabfall auf einen Lasteinsatz von 119 kVA bei einem PF von 0,6.

Spannungskoeffizientkorrektor (VCC):

$VCC = (400/V_{\text{new}})^2$, bei 50 Hz; $VCC = (480/V_{\text{new}})^2$, bei 60 Hz. Beispiel: VCC bei 415 V und 60 Hz beträgt 1,338 [$VCC = (480/415)^2$]. Das bedeutet, dass der Spannungsabfall bei einer gegebenen Leistung bei 415 V demjenigen entspricht, der auf der Kurve mit einem PF von 0,6 abgelesen werden kann, wenn angenommen wird, dass die Last 1,338 Mal größer ist (33% höherer Wert). Bei diesem Beispiel entspricht ein Lasteinsatz von 100 kVA bei 415 V einem Spannungsabfall auf einen Lasteinsatz von 133 kVA bei 480 V.

50Hz Kurzschlussabnahmekurven - Leerlauf bei Nenndrehzahl

ECP32 2M4 C

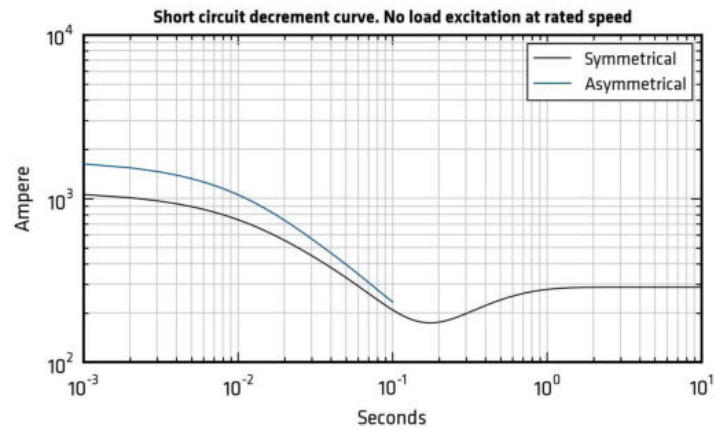

* Bitte lesen Sie Tabellen auf Seite 6

Zusätzliche Charakteristiken

Daten		ECP32 2M4 C	
		50 Hz	
Dämpferkäfig		Aluminium	
Stator Wicklungs-Widerstand (20°C)	Ω	0,053	
Rotor Wicklungs-Widerstand (20°C)	Ω	1,576	
Erregerstator Widerstand (20°C)	Ω	10,6	
Erregerrotor Widerstand (20°C)	Ω	0,417	
Generator-Gesamtgewicht	kg	212,0	
Unsymmetrische magnetische Anziehungskraft	kN/mm	4,6	
Kühlluftmenge	m ³ /min	15,7	
Geräuschpegel bei 1m/7m	dB(A)	72/58	

PQ Diagramm

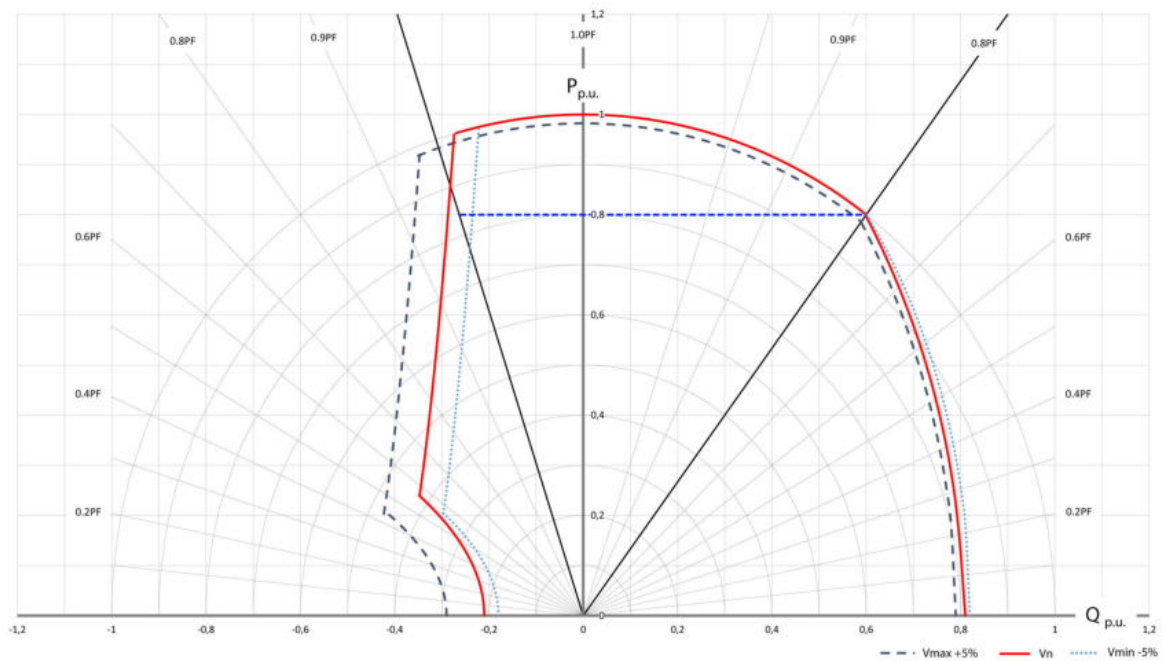

ECP32 2M4 C

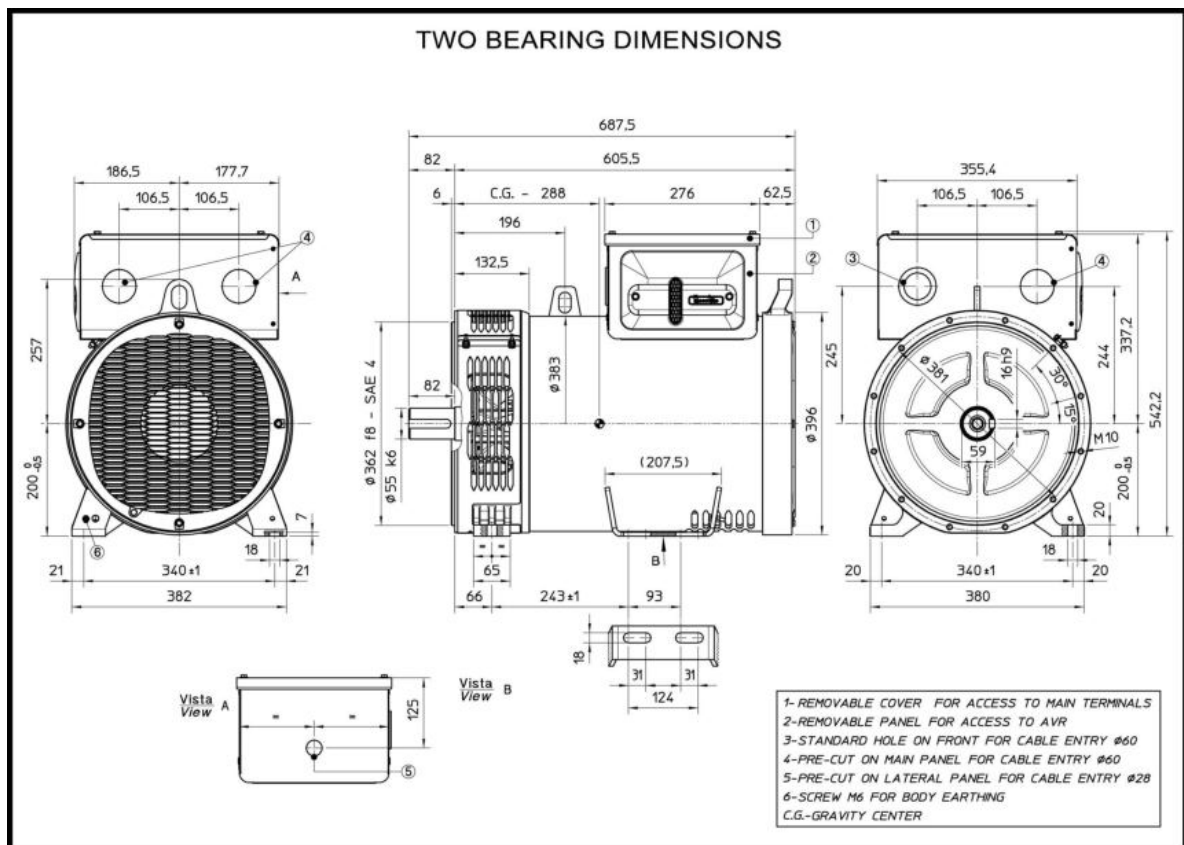
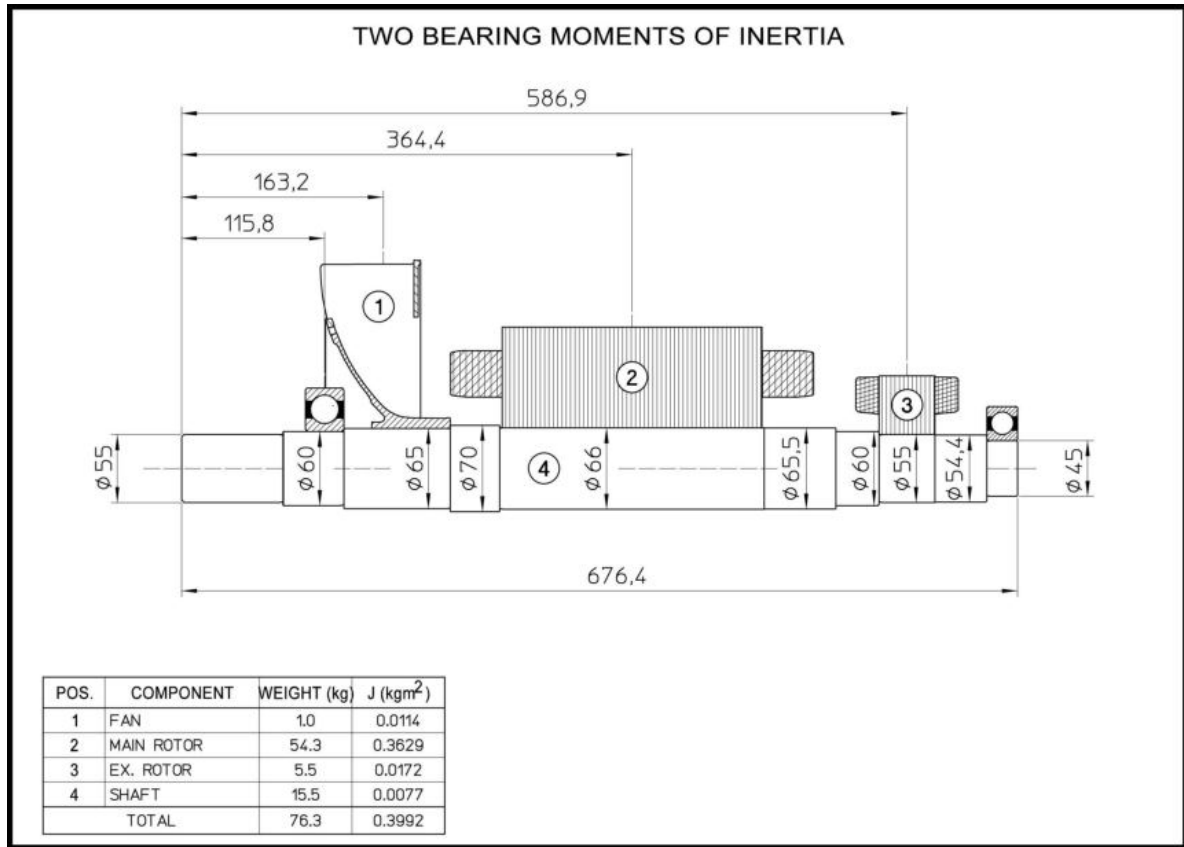

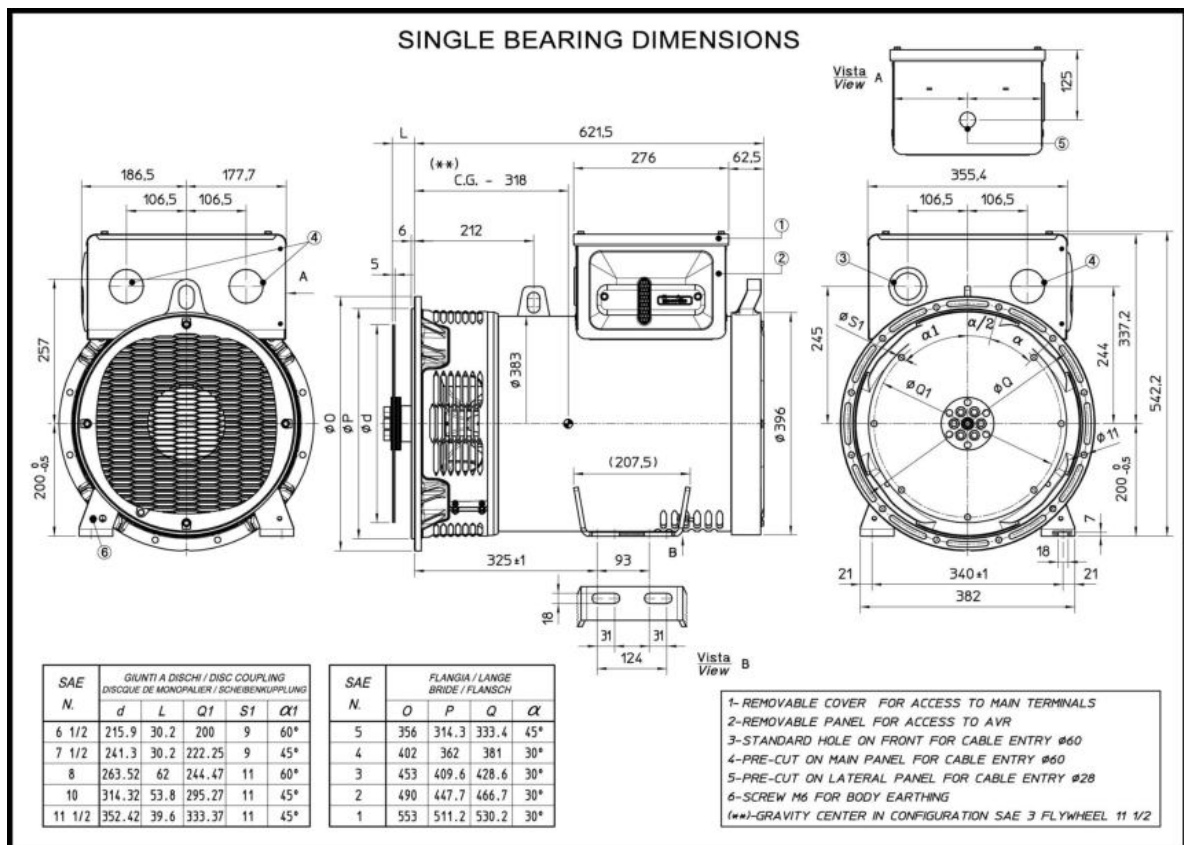
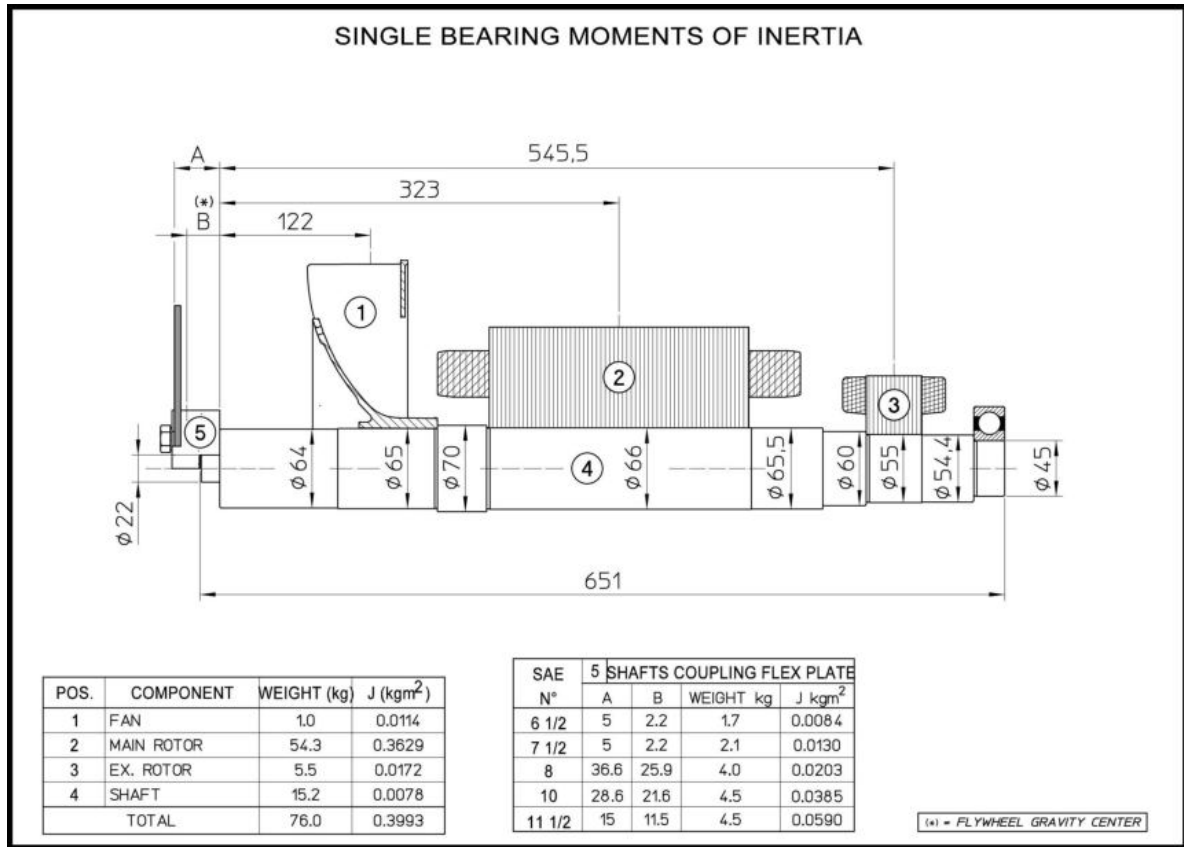



Anmerkung

Lined area for notes, consisting of multiple horizontal lines.

Mecc Alte SpA (HQ)

Via Roma
20 - 36051 Creazzo
Vicenza - ITALY
T: +39 0444 396111
F: +39 0444 396166
E: info@meccalte.it
aftersales@meccalte.it

Mecc Alte Portable

Via Roma
20 - 36051 Creazzo
Vicenza - ITALY
T: +39 0444 396111
F: +39 0444 396166
E: info@meccalte.it
aftersales@meccalte.it

Mecc Alte Power Products srl

Via Melaro
Z - 36075 Montecchio
Maggiore (VI) - ITALY
T: +39 0444 1831295
F: +39 0444 1831306
E: info@meccalte.it
aftersales@meccalte.it

Zanardi Alternatori srl

Via Dei Laghi
48/B - 36077 Altavilla
Vicenza - ITALY
T: +39 0444 370799
F: +39 0444 370330
E: info@zanardialternatori.it

United Kingdom

Mecc Alte U.K. LTD
6 Lands' End Way
Oakham
Rutland LE15 6RF
T: +44 (0) 1572 771160
F: +44 (0) 1572 771161
E: info@meccalte.co.uk
aftersales@meccalte.co.uk

Spain

Mecc Alte España S.A.
C/ Rio Taibilla, 2
Polig. Ind. Los Valeros
03178 Benijofar (Alicante)
T: +34 (0) 96 6702152
F: +34 (0) 96 6700103
E: info@meccalte.es
aftersales@meccalte.es

China

Mecc Alte Alternator Haimen LTD
755 Nanhai East Rd
Jiangsu HEDZ 226100 PRC
T: +86 (0) 513 82325758
F: +86 (0) 513 82325768
E: info@meccalte.cn
aftersales@meccalte.cn

India

Mecc Alte India PVT LTD
Plot NO: 1, Sanaswadi
Talegaon
Dhamdhare Road Taluka:
Shirur, District:
Pune - 412208
Maharashtra, India
T: +91 2137 619600
F: +91 2137 619699
E: info@meccalte.in
aftersales@meccalte.in

U.S.A. and Canada

Mecc Alte Inc.
1229 Adams Drive
McHenry, IL, 60051
T: +1 815 344 0530
F: +1 815 344 0535
E: info@meccalte.us
aftersales@meccalte.us

Germany

Mecc Alte Generatoren GmbH
Ensener Weg 21
D-51149 Köln
T: +49 (0) 2203 503810
F: +49 (0) 2203 503796
E: info@meccalte.de
aftersales@meccalte.de

Australia

Mecc Alte Alternators PTY LTD
10 Duncan Road, PO Box 1046
Dry Creek, 5094, South
Australia
T: +61 (0) 8 8349 8422
F: +61 (0) 8 8349 8455
E: info@meccalte.com.au
aftersales@meccalte.com.au

France

Mecc Alte International S.A.
Z.E.La Gagnerie
16330 ST.Amant de Boixe
T: +33 (0) 545 397562
F: +33 (0) 545 398820
E: info@meccalte.fr
aftersales@meccalte.fr

Far East

Mecc Alte (F.E.) PTE LTD
19 Kian Teck Drive
Singapore 628836
T: +65 62 657122
F: +65 62 653991
E: info@meccalte.com.sg
aftersales@meccalte.com.sg



www.meccalte.com