

# User Manual M1

Direct current / Direct voltage signals 0-20 mA, 4-20 mA, 0-10 VDC



Installation size 96x48 mm (BxH)



Installation size 48x24 mm (BxH)



Installation size mm (BxH)



Installation size 72x36 mm (BxH)

## Technical features:

- red display of -1999...9999 digits (optional: green, orange or blue)
- minimal installation depth: 25 mm, 27 mm, 60 mm or 71 mm without plug-in terminal
- adjustment via factory default or directly on the sensor signal
- min/max-memory
- 10 adjustable supporting points
- display flashing at threshold exceedance / undershooting
- tara function
- programming interlock via access code
- protection class IP65 at the front
- plug-in terminal
- pc-based configuration software PM-TOOL with CD and USB-adapter
- on request: devices for operating temperature of -40°...+70°C (M1O)



# Content

<b>1. Brief description</b>	<b>1</b>
<b>2. Assembly</b>	<b>1</b>
<b>3. Electrical connection and connection examples</b>	<b>2</b>
<b>4. Function description and operation</b>	<b>4</b>
<b>4.1. Programming software PM-TOOL</b>	<b>4</b>
<b>5. Setting up the device</b>	<b>5</b>
<b>5.1. Switching on</b>	<b>5</b>
<b>5.2. Standard parameterisation (flat operation level)</b>	<b>5</b>
Value assignment for control of the signal input	
<b>5.3. Programming interlock <i>RUN</i></b>	<b>6</b>
Activation/Deactivation of the programming interlock or change into extended parameterisation	
<b>5.4. Extended parameterisation</b>	<b>7</b>
Superior device functions like e.g.:	
- rescaling of the input signals, <i>ENDR, OFFR</i>	<b>7</b>
- parameterisation of a TARA-function, <i>TARA</i>	<b>7</b>
- zero point slowdown of the input signal, <i>ZERO</i>	<b>7</b>
- allocation of functions onto the navigation keys, <i>TRST</i>	<b>8</b>
- adjustment of limit values for optical alarm, <i>LI-1/2</i>	<b>8</b>
- safety parameter for locking of the programming, <i>CODE</i>	<b>10</b>
- input of supporting points for the linearisation of the input signals, <i>SPCT</i>	<b>10</b>
<b>6. Reset to default values</b>	<b>11</b>
Reset of the parameter onto delivery condition	
<b>7. Alarms / Switching points</b>	<b>12</b>
Functional principle of the optical switching points	
<b>8. Technical data</b>	<b>13</b>
<b>9. Safety advices</b>	<b>15</b>
<b>10. Error elimination</b>	<b>16</b>

## 1. Brief description

The panel instrument **M1-x1** is a 4-digit device for direct voltage and direct current signals and a visual limit value monitoring via the display. The configuration happens via three front keys or via the optional PC-software PM-TOOL. An integrated programming lock prevents unrequested changes of the parameter and can be unlocked again via an individual code.

The electrical connection happens on the rear side via plug-in terminals.

Selectable functions like e.g. the recall of the min/max-value, a zero point slowdown, a direct change of the limit value in operating mode and additional measuring supporting points for a linearisation of the input signal, complete the modern device concept.

## 2. Assembly

Please read the *Safety advices* on *page 16* before installation and keep this user manual for future reference.

The example given below shows a device in housing size 96x48mm.

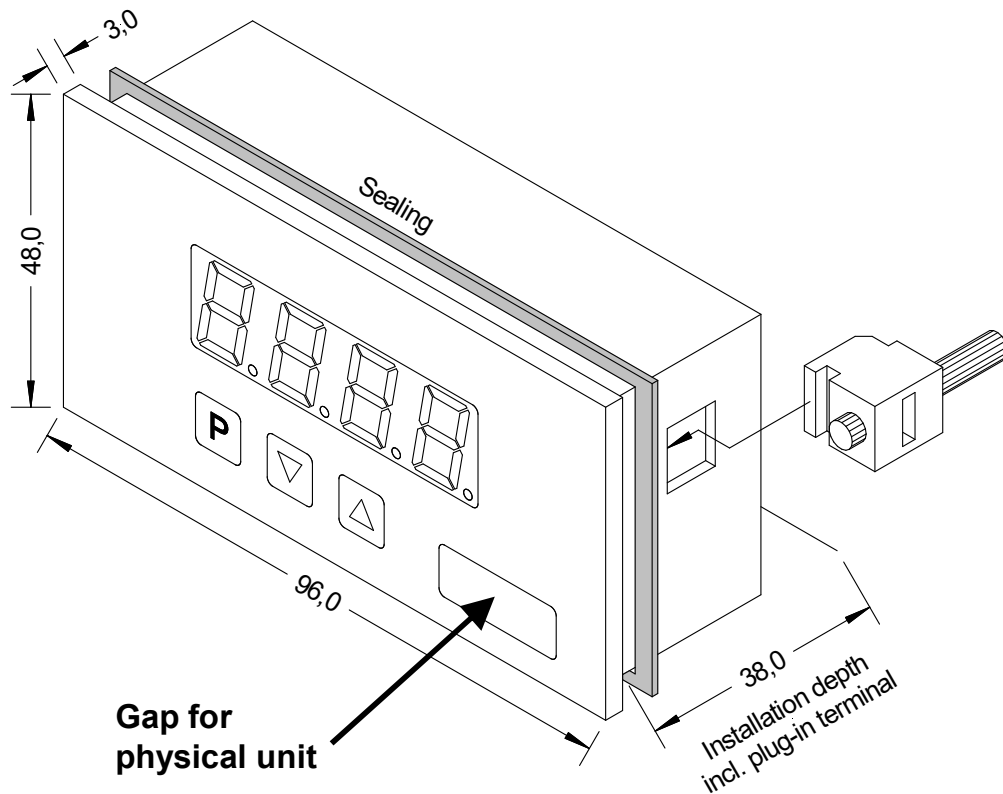

1. After removing the fixing elements, insert the device.
2. Check the seal to make sure it fits securely.
3. Click the fixing elements back into place and tighten the clamping screws by hand. Then use a screwdriver to tighten them another half a turn.

**CAUTION!** The torque should not exceed 0.1 Nm!

### 3. Electrical connection

Type M1-1VR4B.0001.570xD (96x48 mm)

Type M1-3VR4B.0001.570xD (96x24 mm)

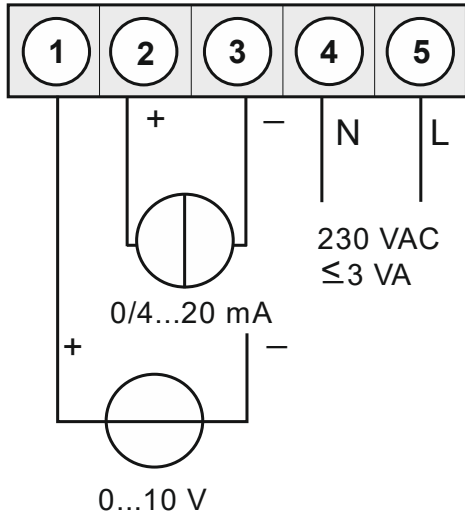

Type M1-1VR4B.0001.770xD (96x48 mm)

Type M1-3VR4B.0001.770xD (96x24 mm)

Type M1-7VR4A.0001.770xD (48x24 mm)

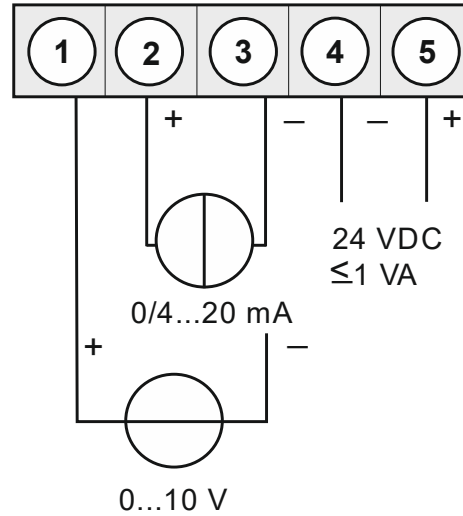

Type M1-6VR4B.0001.570CD / M1-6VR4B.0001.770xD (Housing 72x36 mm)

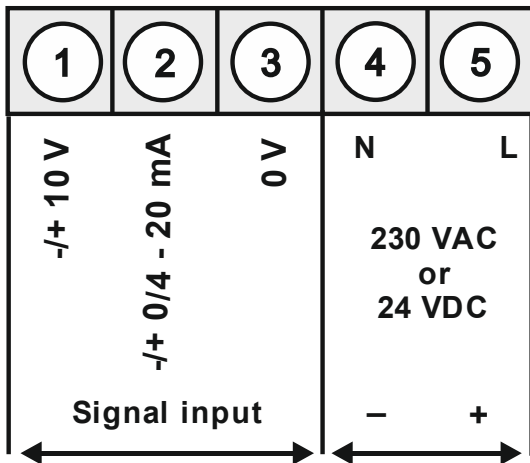

Option:

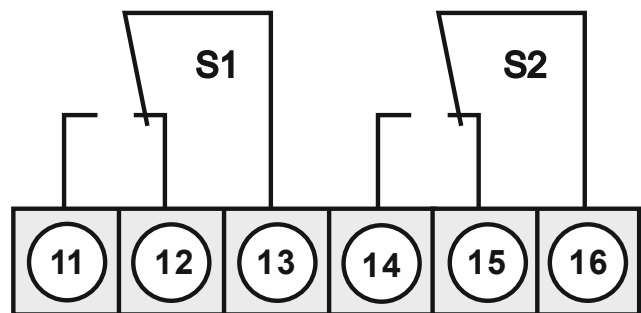

**Connection examples:**

Below you find some connection examples, which demonstrate some practical applications:

**M1-1/3/7 in combination with a 2-wire-sensor 4-20 mA**

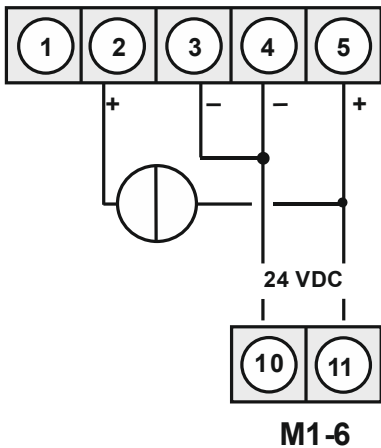

**M1-1/3/7 in combination with a 3-wire-sensor 0/4-20 mA**

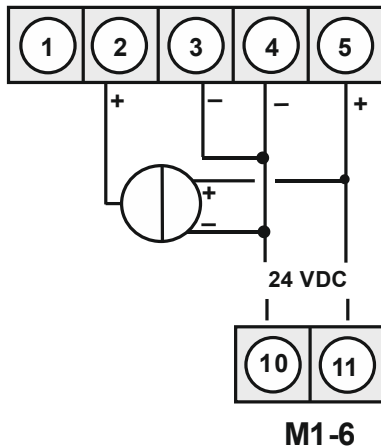

**M1-1/3/7 in combination with a 3-wire-sensor 0-10 V**

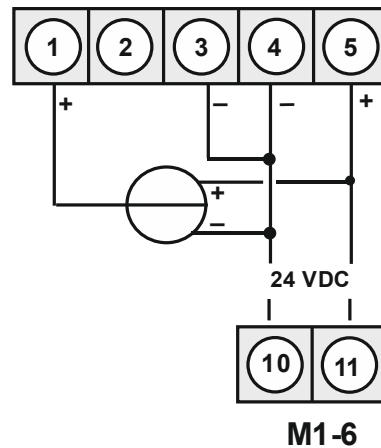

**M1-1/3 in combination with a 2-wire-sensor 4-20 mA**

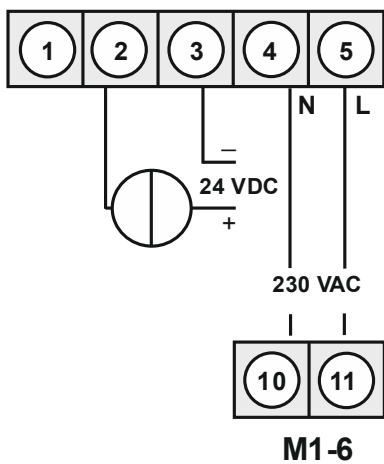

**M1-1/3 in combination with a 3-wire-sensor 0/4-20 mA**

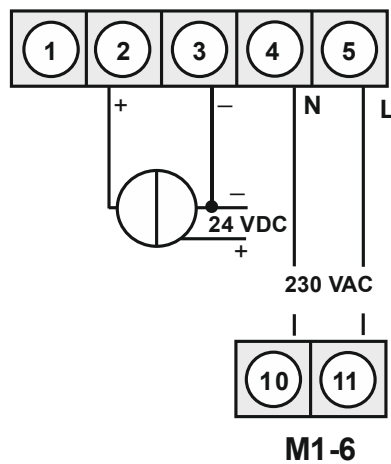

**M1-1/3 in combination with a 3-wire-sensor 0-10 V**

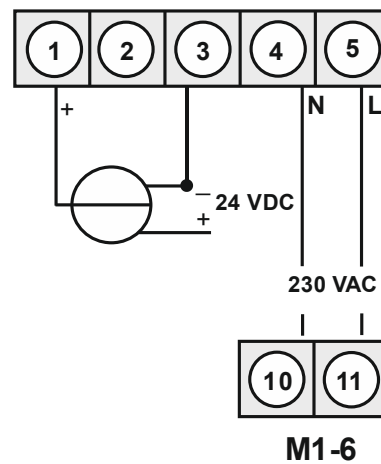

## 4. Function description and operation

### Operation

The operation is divided into two different levels.

### Menu Level

Here it is possible to navigate between the individual menu items.

### Parameterization level:

The parameters stored in the menu item can be parameterized here.

Functions that can be adjusted or changed are always indicated with a flashing of the display. Adjustments made at the parameterization level should be always confirmed by pressing the **[P]** key to save them. However, the display automatically saves all adjustments and then switches to operation mode if no further keys are pressed within 10 seconds.

Level	Button	Description
Menu level	<b>[P]</b>	Change to parameterization level with the relevant parameters
	<b>[▼] [▲]</b>	For navigation at the menu level
Parameter level	<b>[P]</b>	To confirm the changes made at the parameterization level
	<b>[▼] [▲]</b>	To change the value or setting

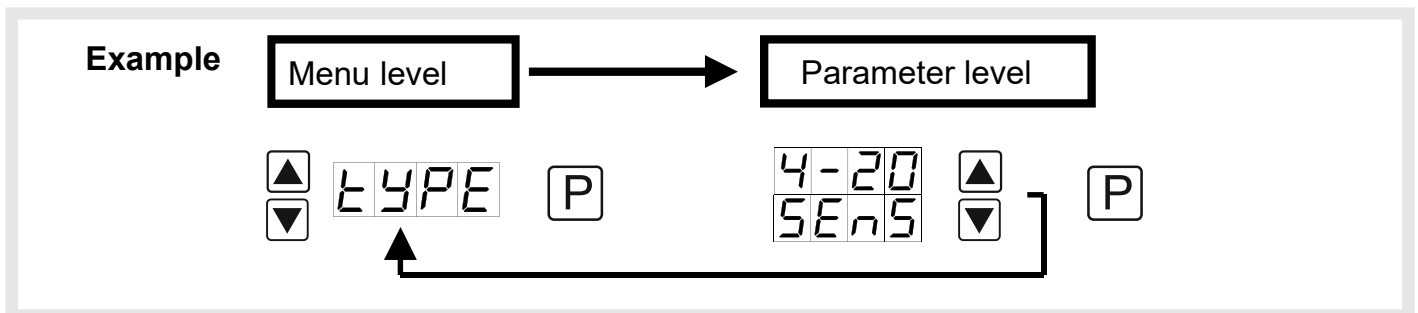

### 4.1. Programming via configuration software PM-TOOL-MUSB4:

You receive the software on CD incl. an USB-cable with a device adapter. The connection is done via a 4-pole micromatch connector plug on the back and the PC is connected via an USB connector plug.

#### System requirements: PC with USB interface

#### Software: Windows XP, Windows Vista

With this tool the device configuration can be created, skipped and saved on the PC. Via the easy to handle program surface the parameter can be changed, whereat the mode of operation and the possible selection options can be preset via the program.

### CAUTION!

During parameterisation with connected measuring signal, make sure that the measuring signal has no mass supply to the programming plug. The programming adapter is galvanic not isolated and directly connected with the PC. Via polarity of the input signal, a current can discharge via the adapter and destroy the device as well as other connected components!

## 5. Setting up the device

### 5.1. Switching on





Once the installation is complete, you can start the device by applying the current loop. Check beforehand once again that all the electrical connections are correct.

#### Starting sequence

For 1 second during the switching-on process, the segment test (*8 8 8 8 8*) is displayed, followed by an indication of the software type and, after that, also for 1 second, the software version. After the start-up sequence, the device switches to operation/display mode.

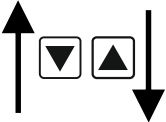
### 5.2. Standard parameterization:

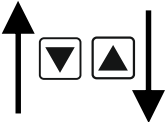
To be able to parameterize the display, press the **[P]** key in operating mode for 1 second. The display then changes to the menu level with the first menu item *TYPE*.

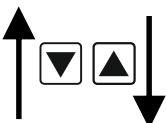
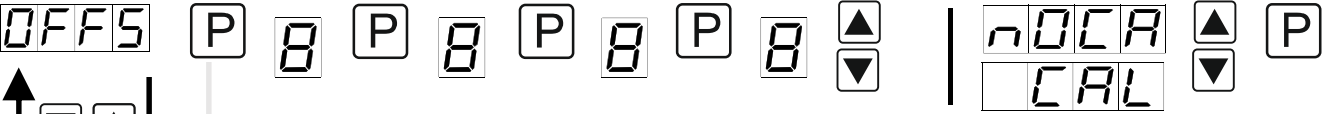
Menu level	Parameterization level
	<p><b>Selection of the input signal, <i>TYPE</i>:</b> Default: <i>SENS</i></p>  <p>There are several measuring inputs options: 0/4-20 mA or 0-10 VDC signals as the works calibration (without application of the sensor signal) and <i>SENS</i> as the sensor calibration (with the sensor applied). Confirm the selection with <b>[P]</b> and the display switches back to menu level.</p>
	<p><b>Setting the measuring range end value, <i>END</i>:</b> Default: <i>1000</i></p>  <p>Set the end value from the smallest to the highest digit with <b>[▲]</b> <b>[▼]</b> and confirm each digit with <b>[P]</b>. A minus sign can only be parameterized on the highest value digit. After the last digit, the display switches back to the menu level. If <i>SENS</i> was selected as the input option, one can only select between <i>NOCA</i> and <i>CAL</i>. With <i>NOCA</i>, only the previously set display value is taken over, and with <i>CAL</i>, the device takes over both the display value and the analogue input value.</p>
	<p><b>Setting the measuring range start/offset value, <i>OFFS</i>:</b> Default: <i>0000</i></p>  <p>Enter the start/offset value from the smallest to the highest digit <b>[▲]</b> <b>[▼]</b> and confirm each digit with <b>[P]</b>. After the last digit the display switches back to the menu level. If <i>SENS</i> was selected as the input option, one can only select between <i>NOCA</i> and <i>CAL</i>. With <i>NOCA</i>, only the previously set display value is taken over, and with <i>CAL</i>, the device takes over both the display value and the analogue input value.</p>



## Menu level

## Parameterization level

Setting the decimal point, *DOT*:

Default: 0

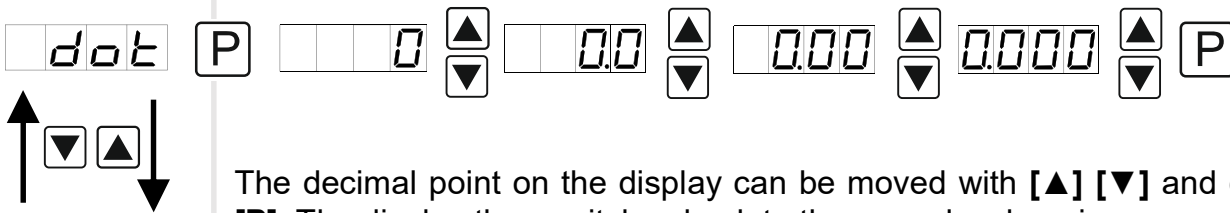

The decimal point on the display can be moved with [**▲**] [**▼**] and confirmed with [**P**]. The display then switches back to the menu level again.

Setting the display time, *SEC*:

Default: 01.0

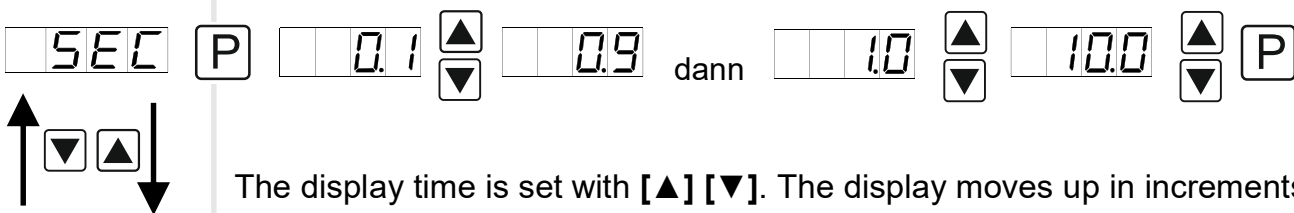

The display time is set with [**▲**] [**▼**]. The display moves up in increments of 0.1 up to 1 second and in increments of 1.0 to 10.0 seconds. Confirm the selection by pressing the [**P**] button. The display then switches back to the menu level again.

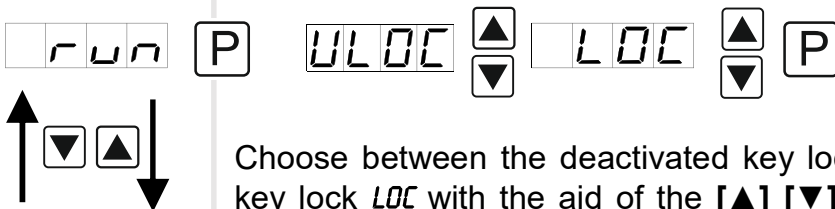
5.3. Programming interlock *RUN*Activation/deactivation of the programming lock and completion of the standard parameterization, *RUN*:Default: *ULOC*



Choose between the deactivated key lock *ULOC* (works setting) and the activated key lock *LOC* with the aid of the [**▲**] [**▼**] keys. Make the selection with [**P**]. After this, the display confirms the settings with "- - -", and automatically switches to operating mode. If *LOC* was selected, the keyboard is locked. To get back into the menu level, press [**P**] for 3 seconds in operating mode. Now enter the *CODE* (works setting 1234) that appears using the [**▲**] [**▼**] keys plus [**P**] to unlock the keyboard. *FAIL* appears if the input is wrong.





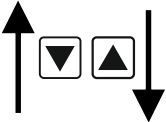
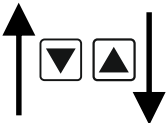
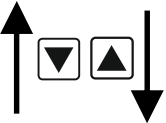
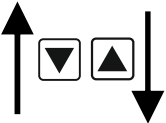

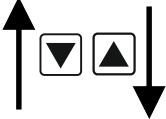
### 5.4. Extended parameterization

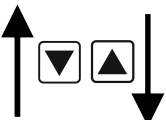
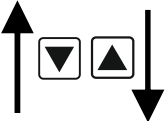
By pressing the [▲] & [▼] keys during standard parameterization for one second, the display switches to the extended parameterization mode. Operation is the same as in standard parameterization.

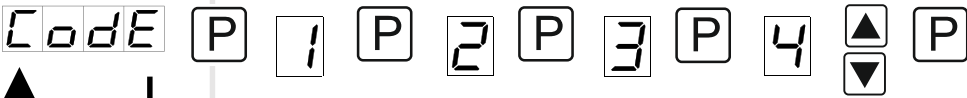
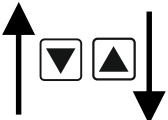
Menu level	Parameterization level
	<p><b>Rescaling the measuring input values, <i>ENDA</i>:</b></p> <p>With the aid of this function, one can rescale the input value of <b>e.g. 19,5 mA</b> (works setting) without applying a measuring signal. If sensor calibration has been selected, these parameters are not available.</p>
	<p><b>Rescaling the measuring input values, <i>OFFA</i>:</b></p> <p>With the aid of this function, one can rescale the input value of <b>e.g. 3,5 mA</b> (works setting) without applying a measuring signal. If sensor calibration has been selected, these parameters are not available.</p>
	<p><b>Setting the tare/offset value, <i>TARA</i>:</b></p> <p><b>Default: 0</b></p> <p>The given value is added to the linearized value. In this way, the characteristic line can be shifted by the selected amount.</p>
	<p><b>Zero point slowdown, <i>ZERO</i>:</b></p> <p><b>Default: 0</b></p> <p>With zero point slowdown, a value range around zero can be preselected at which the display shows zero. If, for example, a 10 is set, the display would show a zero in the range from -10 to +10 and continue below it with -11 and above it with +11.</p>

Menu level	Parameterization level
	<p><b>Min/max-value inquiry - assignment of key functions, <i>TAST</i>:</b>  <b>Default: <i>NO</i></b></p> <p><i>TAST</i> [P] <i>EHER</i> [▲] [▼] <i>LI.12</i> [▲] [▼] <i>TARA</i> [▲] [▼] [ ] <i>no</i> [▲] [▼] [P]</p> <p>For the operating mode enter here either a min/max-value inquiry or a threshold value correction on the arrow keys.          If the min/max-memory was activated with <i>EHER</i>, the measured min/max-values will be saved during operation and can be called up via the arrow keys [▲] [▼]. When the device is restarted or the buttons are pressed simultaneously, the values are lost or deleted.          If the threshold value correction <i>LI.1</i> was selected, the limit values can be changed during operation without hindering the operating procedure.          With <i>TARA</i> the display is tared to zero and is saved permanently as offset. The device confirms the correct taring by showing <i>0000</i> in the display. If <i>NO</i> was parameterized, the navigation keys [▼] [▲] have no function in operating mode.</p>
	<p><b>Flashing of display, <i>FLAS</i>:</b>  <b>Default: <i>NO</i></b></p> <p><i>FLAS</i> [P] <i>LI-1</i> [▲] [▼] <i>LI-2</i> [▲] [▼] <i>LI.12</i> [▲] [▼] [ ] <i>no</i> [▲] [▼] [P]</p> <p>Here, the flashing of the display can be added as an extra alarm function, either to the first limit value (select: <i>LI-1</i>), the second limit value (select: <i>LI-2</i>) or to both limit values (select: <i>LI-12</i>). With <i>NO</i> (works setting), no flashing is assigned at all.</p>
	<p><b>Limit values, <i>LI-1</i>:</b>  <b>Default: <i>0200</i></b></p> <p><i>LI-1</i> [P] [0] [P] [0] [P] [0] [P] [0] [▲] [▼] [P]</p> <p>For both limit values, two different values can be parameterized. With this, the parameters for each limit value are called up one after the other.</p>
	<p><b>Hysteresis for limit values, <i>HY-1</i>:</b>  <b>Default: <i>0000</i></b></p> <p><i>HY-1</i> [P] [0] [P] [0] [P] [0] [P] [0] [▲] [▼] [P]</p> <p>For both limit values, a hysteresis function exists that reacts according to the functional principle (operating current / quiescent current).</p>

Menu level	Parameterization level
	<p><b>Function if display falls below / exceeds limit value, FU-1:</b>  <b>Default: HIGH</b></p> <p><b>FU-1</b> [P] <b>H I G H</b> [▲] [▼] <b>L O W U</b> [▲] [▼] [P]</p> <p>To indicate if the value falls below the lower limit value, <i>LOWU</i> can be selected (LOW = lower limit value) and if it goes above the upper limit value, <i>HIGH</i> can be selected (HIGH = upper limit value). LOW corresponds to the quiescent current principle and HIGH to the operating current principle.</p>
	<p><b>Limit value, LI-2:</b>  <b>Default: 0300</b></p> <p><b>LI-2</b> [P] [0] [P] [0] [P] [0] [P] [0] [▲] [▼] [P]</p> <p>For both limit values, two different values can be parameterized. With this, the parameters for each limit value are called up one after the other.</p>
	<p><b>Hysteresis for limit values, HY-2:</b>  <b>Default: 0000</b></p> <p><b>HY-2</b> [P] [0] [P] [0] [P] [0] [P] [0] [▲] [▼] [P]</p> <p>For both limit values, a hysteresis function exists that reacts according to the functional principle (operating current / quiescent current).</p>
	<p><b>Function if display falls below / exceeds limit value, FU-2:</b>  <b>Default: HIGH</b></p> <p><b>FU-2</b> [P] <b>H I G H</b> [▲] [▼] <b>L O W U</b> [▲] [▼] [P]</p> <p>To indicate if the value falls below the lower limit value, <i>LOWU</i> can be selected (LOW = lower limit value) and if it goes above the upper limit value, <i>HIGH</i> can be selected (HIGH = upper limit value). LOW corresponds to the quiescent current principle and HIGH to the operating current principle.</p>

Menu level	Parameterization level
	<p><b>Setting the code, <i>CODE</i>:</b> Default: 1234</p> <p></p> <p>With this setting, it is possible to select an individual code (works setting 1 2 3 4) for locking the keyboard. To lock/release the key, proceed according to menu item <i>RUN</i>.</p>
	<p><b>Supporting points - number of additional supporting points, <i>SPCT</i>:</b> Default: 0</p> <p></p> <p>In addition to the start and end value, 8 extra supporting points can be defined to linearise non-linear sensor values. Only the activated set point parameters are displayed.</p>
	<p><b>Display values for supporting points, <i>DIS1 ... DIS8</i>:</b></p> <p></p> <p>Under this parameter the supporting points are defined on a value basis. At the sensor calibration one will be asked at the end (like at final value/offset, too), if a calibration shall be triggered.</p>
	<p><b>Analogue values for supporting points, <i>INP1 ... INP8</i>:</b></p> <p></p> <p>Supporting points are always preset according to the selected input signal mV. Here the desired analog values can be freely adjusted in ascending order.</p>

## 6. Reset to default values

To return the unit to a **defined basic state**, a reset can be carried out to the default values.

The following procedure should be used:

- Switch off the power supply
- Press **[P]**-button
- Switch on voltage supply and press **[P]**-button until „- - - -“ is shown in the display.

With reset, the default values of the program table are loaded and used for subsequent operation. This sets the unit back into the state in which it was supplied.

**Caution! All application-related data are lost.**

## 7. Functional principle of the switching points

### Limit value exceedance "HIGH"

The switching point S1-S2 is "off" below the threshold and "on" on reaching the threshold.

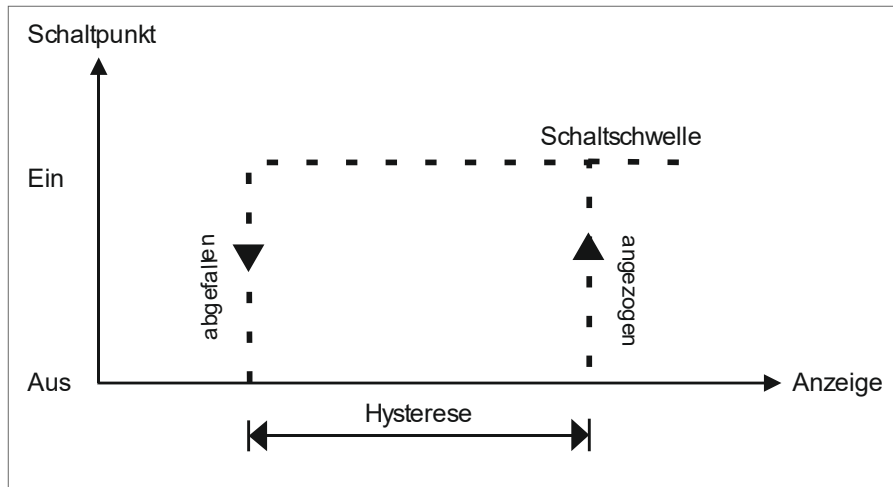

### Limit value undercut "LOW"

The switching point S1-S2 is "on" below the threshold and switched "off" on reaching the threshold.

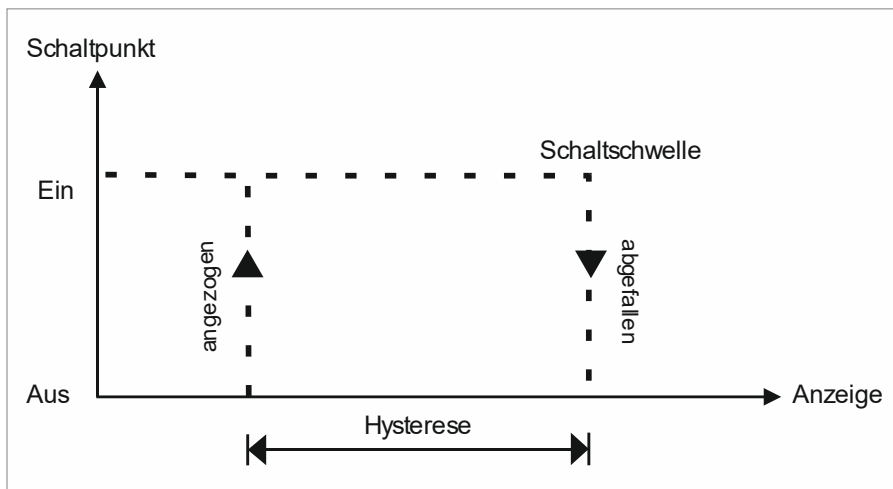

### Alarms / optical switching point display

An activated switching point can be optically indicated by flashing of the 7-segment display.

Functional principle of the alarms	
<b>Alarm</b>	Deactivated, display value
<b>Threshold</b>	Threshold value / limit value for switch over
<b>Hysteresis</b>	Width of the window between the thresholds
<b>Operating principle</b>	Limit value exceedance / limit value undercut

## 8. Technical data

<b>Housing</b>				
Dimensions	96x48x25 mm (BxHxD), D = 38 mm including plug-in terminal			
	96x24x60 mm (BxHxD), D = 74 mm including plug-in terminal			
	72x36x71 mm (BxHxD), D = 100 mm including plug-in terminal			
	48x24x27 mm (BxHxD), D = 54 mm including plug-in terminal			
Panel cut-out	92.0 <sup>+0.8</sup> x 45.0 <sup>+0.6</sup> mm (Housing 96x48 mm)			
	92.0 <sup>+0.8</sup> x 22.2 <sup>+0.3</sup> mm (Housing 96x24 mm)			
	68.0 <sup>+0.7</sup> x 32.0 <sup>+0.7</sup> mm (Housing 72x36 mm)			
	45.0 <sup>+0.6</sup> x 22.2 <sup>+0.3</sup> mm (Housing 48x24 mm)			
Insulation thickness	up to 3 mm			
Fixing	snap-in screw element			
Material	PC Polycarbonate, black, UL94V-0			
Sealing material	EPDM, 65 Shore, black			
Protection class	standard IP65 (front), IP00 (back side)			
Weight	approx. 100 g (96x48 mm, 96x24 mm, 48x24 mm) approx. 200 g (72x36 mm)			
Connection	plug-in terminal; wire cross section up to 2.5 mm <sup>2</sup>			
<b>Display</b>				
Digit height	10 mm (housing 48x24 mm) 14 mm (housing 96x48 mm, 96x24 mm, 72x36 mm)			
Segment colour	red (optional green, orange or blue)			
Display range	-1999 to 9999			
Setpoints	optical display flashing			
Overflow	horizontal bars at the top			
Underflow	horizontal bars at the bottom			
Display time	0.1 to 10.0 seconds			
<b>Input</b>	<b>Measuring range</b>	<b>Ri</b>	<b>Measuring fault</b>	<b>Digit</b>
min. -22...max. 24 mA	0/4–20 mA	~ 100 Ω	0.1 % of measuring range	±1
min. -12...max. 12 VDC	0–10 VDC	~ 200 kΩ	0.1 % of measuring range	±1



<b>Switching outputs</b>	<b>Type</b>	<b>Switching contact</b>
Only in housing size <b>72x36 mm</b>	2 relays with change-over contact	contact voltage 30 VDC/AC, max. 2 A resistive load operating life < 30 mV/< 10 mA – minimum $2.5 \times 10^6$ 30 VDC / 1 A – minimum $5 \times 10^5$ 30 VDC / 2 A – minimum $1 \times 10^5$
<b>Accuracy</b>		
Temperature drift	100 ppm / K	
Measuring time	0.1...10.0 seconds	
Measuring principle	U/F-conversion	
Resolution	approx. 18 bit at 1s measuring time	
Power pack	230 VAC $\pm 10\%$ max. 3 VA 24 VDC $\pm 10\%$ max. 1 VA	
<b>Memory</b>		
		EEPROM
Data life	$\geq 100$ years at 25°C	
<b>Ambient conditions</b>		
Working temperature	0°C...60°C	
Storing temperature	-20°C...80°C	
Weathering resistance	relative humidity 0-80% on years average without dew	
<b>EMV</b>		
		EN 61326
<b>CE-sign</b>		
		Conformity to directive 2014/30/EU
<b>Safety standard</b>		
		According to low voltage directive 2014/35/EU EN 61010; EN 60664-1

## 9. Safety advices

Please read the following safety advices and the assembly *chapter 2* before installation and keep it for future reference.

### Proper use

The **M1-x1-device** is designed for the evaluation and display of sensor signals.



**Danger! Careless use or improper operation can result in personal injury and/or cause damage to the equipment.**

### Control of the device

The panel meters are checked before dispatch and sent out in perfect condition. Should there be any visible damage, we recommend close examination of the packaging. Please inform the supplier immediately of any damage.



### Installation

The **M1-x1-device** must be installed by a suitably **qualified specialist** (e.g. with a qualification in industrial electronics).

### Notes on installation

- There must be no magnetic or electric fields in the vicinity of the device, e.g. due to transformers, mobile phones or electrostatic discharge.
- The fuse rating of the supply voltage should not exceed a value of 0.5A N.B. fuse!
- Do not install **inductive consumers** (relays, solenoid valves etc.) near the device and **suppress** any interference with the aid of RC spark extinguishing combinations or free-wheeling diodes.
- Keep input, output and supply lines separate from each other and do not lay them parallel with each other. Position “go” and “return lines” next to one another. Where possible use twisted pair. So, the best measuring results can be received.
- Screen off and twist sensor lines. Do not lay current-carrying lines in the vicinity. Connect the **screening on one side** on a suitable potential equaliser (normally signal ground).
- The device is not suitable for installation in areas where there is a risk of explosion.
- Any electrical connection deviating from the connection diagram can endanger human life and/or can destroy the equipment.
- The terminal area of the devices is part of the service. Here electrostatic discharge needs to be avoided. Attention! High voltages can cause dangerous body currents.
- Galvanic isolated potentials within one complex need to be placed on an appropriate point (normally earth or machines ground). So, a lower disturbance sensibility against impacted energy can be reached and dangerous potentials, that can occur on long lines or due to faulty wiring, can be avoided.

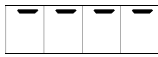
## 10. Error elimination

	Error description	Measures
1.	<p>The unit permanently indicates overflow.</p> 	<ul style="list-style-type: none"> <li>• The input has a very high measurement, check the measuring circuit.</li> <li>• With a selected input with a low voltage signal, it is only connected on one side or the input is open.</li> <li>• Not all of the activated supporting points are parameterised. Check if the relevant parameters are adjusted correctly.</li> </ul>
2.	<p>The unit permanently shows underflow.</p> 	<ul style="list-style-type: none"> <li>• The input has a very low measurement, check the measuring circuit .</li> <li>• With a selected input with a low voltage signal, it is only connected on one side or the input is open.</li> <li>• Not all of the activated supporting points are parameterised. Check if the relevant parameters are adjusted correctly.</li> </ul>
3.	<p>The word <i>HELP</i> lights up in the 7-segment display.</p>	<ul style="list-style-type: none"> <li>• The unit has found an error in the configuration memory. Perform a reset to the default values and reconfigure the unit according to your application.</li> </ul>
4.	<p>Program numbers for parameterising of the input are not accessible.</p>	<ul style="list-style-type: none"> <li>• Programming lock is activated</li> <li>• Enter correct code</li> </ul>
5.	<p><i>ERR1</i> lights up in the 7-segment display.</p>	<ul style="list-style-type: none"> <li>• Please contact the manufacturer if errors of this kind occur.</li> </ul>
6.	<p>The device does not react as expected.</p>	<ul style="list-style-type: none"> <li>• If you are not sure if the device has been parameterised before, then follow the steps as written in <i>chapter 6</i> and set it back to its delivery status.</li> </ul>

