

PT060R-13-LI3-H1131

Pressure Transmitter – With Current Output (2-Wire)

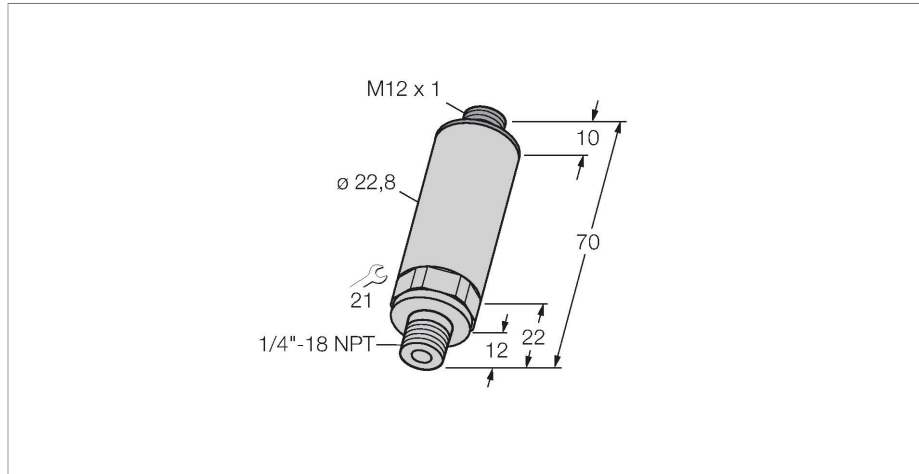

Features

- Compact and robust design
- Pressure connection with integrated peak pressure aperture
- Accuracy hardly affected by temperature within entire range -40...+125°C
- Excellent EMC properties
- Pressure range 0...60 bar rel.

Wiring diagram

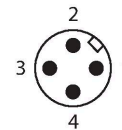
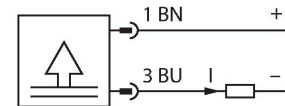

Technical data

Type	PT060R-13-LI3-H1131
ID	6831506
Medium temperature	-40...+125 °C
Pressure range	
Pressure type	Relative pressure
Pressure range	0...60 bar
	0...870.23 psi
	0...6 MPa
Admissible overpressure	≤ 150 bar
Burst pressure	≥ 150 bar
Response time	< 2 ms, typ. 1 ms
Long-term stability	± 1 % FS, In accordance with DIN EN 60770
Power supply	
Operating voltage	8...33 VDC
Current consumption	≤ 20 mA
Protective measure	SELV according to EN 50178
Short-circuit/reverse polarity protection	yes / yes
Insulation class	III
Outputs	
Output 1	Analog output
Output function	Analog output current
Analog output	
Current output	4...20 mA

Functional principle

The pressure transmitters of the PT...-1 series operate with piezo-resistive ceramic measuring cells. The ceramic diaphragm is unbalanced in proportion to the pressure applied. Depending on the sensor type used, the processed signal is provided as an analog output signal 4...20mA (2-wire) or 0...10V (3-wire).

Technical data

Load	≤ 1 kΩ
Resolution	<± 0.1 % FS
Accuracy LHR	± 0.3 % FS BSL
Calibration accuracy 0-point	0.3 % FS
Calibration accuracy full scale	0.3 % FS
Housing material	Stainless-steel/Plastic, 1.4305 (AISI 303)
Process connection	1/4" NPT-18 male thread
Pressure connection material	Stainless steel 1.4305 (AISI 303)
Pressure transducer material	Ceramic Al ₂ O ₃
Sealing material	FPM
Wrench size pressure connection / coupling nut	SW 21
Max. tightening torque of housing nut	20 Nm
Electrical connection	Connector, M12 × 1
Protection class	IP67
Ambient temperature	-40...+85 °C
Storage temperature	-40...+85 °C
Shock resistance	100 g (11 ms) , acc. to IEC 68-2-27
Vibration resistance	20 x g (9...2000 Hz, 2...9 Hz with an amplitude +/-15 mm), acc. to IEC 68-2-6
Reference conditions acc. to IEC 61298-1	
Temperature	15...+25 °C
Atmospheric pressure	860...1060 hPa abs.
Humidity	45...75 % rel.
Auxiliary power	24 VDC
Temperature behaviour	
Temperature coefficient span T _{KS}	± 0.15 % of full scale/10 K
Temperature coefficient zero point Tk0	± 0.15 % of full scale/10 K
MTTF	114 years acc. to SN 29500 (Ed. 99) 40 °C

Technical data

Type	PT060R-13-LI3-H1131
ID	6831506
Pressure range	
Pressure type	Relative pressure
Pressure range	0...60 bar
	0...870.23 psi
	0...6 MPa

Technical data

Admissible overpressure	≤ 150 bar
Burst pressure	≥ 150 bar
Response time	< 2 ms, typ. 1 ms
Long-term stability	1 % FS, In accordance with DIN EN 60770
Power supply	
Operating voltage	8...33 VDC
Current consumption	≤ 20 mA
Protective measure	SELV according to EN 50178
Short-circuit/reverse polarity protection	yes / yes
Protection type and class	IP67 / III
Insulation voltage	500 VDC
Outputs	
Output 1	Analog output
Output function	Analog output current
Analog output	
Current output	4...20 mA
Load	≤ 1 kΩ
Resolution	<± 0.1 % FS
Accuracy LHR	± 0.3 % FS BSL
Calibration accuracy 0-point	0.3 % FS
Calibration accuracy full scale	0.3 % FS
Temperature behaviour	
Medium temperature	-40...+125 °C
Temperature coefficient zero point T _{k0}	± 0.15 % of full scale/10 K
Temperature coefficient span T _{ks}	± 0.15 % of full scale/10 K
Ambient conditions	
Ambient temperature	-40...+85 °C
Storage temperature	-40...+85 °C
Vibration resistance	20 x g (9...2000 Hz, 2...9 Hz with an amplitude +/-15 mm), acc. to IEC 68-2-6
Shock resistance	100 g (11 ms) , acc. to IEC 68-2-27
Mechanical data	
Housing material	Stainless-steel/Plastic, 1.4305 (AISI 303)
Pressure connection material	Stainless steel 1.4305 (AISI 303)
Pressure transducer material	Ceramic Al ₂ O ₃
Sealing material	FPM
Process connection	1/4" NPT-18 male thread

Technical data

Wrench size pressure connection / coupling nut	SW 21
Electrical connection	Connector, M12 × 1
Max. tightening torque of housing nut	20 Nm
Reference conditions acc. to IEC 61298-1	
Temperature	15...+25 °C
Atmospheric pressure	860...1060 hPa abs.
Humidity	45...75 % rel.
Auxiliary power	24 VDC
MTTF	114 years acc. to SN 29500 (Ed. 99) 40 °C