



WDATA

2.160-2.180-2.190-2.200-2.240-2.280-2.300-
2.320-2.340-2.360-2.440-2.480-2.540-2.600

AIR COOLED WATER CHILLER FOR OUTDOOR INSTALLATION

Installation and Use Manual

UNIT IDENTIFICATION	4
GENERAL WARNINGS	5
RESIDUAL RISKS	6
RECEPTION	9
INSPECTION UPON RECEPTION.....	9
STORAGE	9
HANDLING	9
POSITIONING	10
GENERAL.....	10
FUNCTIONAL CLEARANCES.....	10
POSITIONING	10
WATER CONNECTIONS	12
GENERAL.....	12
EXCHANGER USE SIDE	12
DIAGRAM OF RECOMMENDED USE SIDE CONNECTION.....	13
RECOVERY EXCHANGER - opTIONAL	13
VICTAULIC CONNECTIONS.....	14
HYDROPACK - opTIONAL.....	14
ELECTRICAL CONNECTION	15
GENERAL.....	15
STANDARD UNIT ELECTRICAL DATA	15
CONNECTION TO THE MAINS	16
FUNCTIONAL CONNECTIONS.....	16
CLIVET TALK MODULAR SYSTEM COMPOSITION	18
MODBUS - CONVERTER CAN to MODBUS via RS 485.....	19
START-UP	21
PRELIMINARY CHECKS.....	21
REFRIGERANT SYSTEM	21
WATER SYSTEM	21
ELECTRICAL SYSTEM.....	21
VERIFy tensions – absorptions.....	22
UNIT EQUIPPED WITH SCROLL COMPRESSORS	22
REMOTE INPUT CONFIGURATIONS	22
SETTING THE SET-POINT	22
EVAPORATOR WATER FLOW RATE	22
REFRIGERANT CIRCUIT PARAMETER CHECK.....	22
CONTROL	23
ROUTINE MAINTENANCE	33
SERVICES : PARTS SUBJECT TO INTERVENTION	33
MAINTENANCE INSPECTIONS.....	34
97/23 CE PED directive	34
PUT AT REST.....	34
REFRIGERANT TABLES	35
TROUBLESHOOTING	36
DECOMMISSIONING OF THE UNIT	38
DISCONNECTING THE UNIT	38
DISMANTLING AND DISPOSAL.....	38
DIMENSIONS	40
TECHNICAL DATA	46

UNIT IDENTIFICATION

SERIAL NUMBER LABEL

The units are identified by the serial number label shown here.

The label lists the type of unit (series and size), serial number, year of manufacture, number of electrical diagram, main technical data, logo and address of the manufacturer.

The label is placed on the unit, generally near the electrical panel and also on the external panelling.

IT MUST NEVER BE REMOVED.

SERIAL NUMBER

This provides unique identification of the machine. It makes it possible to trace the specific features of the unit and to identify the components installed in it.

Without this number, it is not possible to identify with certainty the spare parts that are specific to that unit.

When requesting assistance, always provide the type of machine and the serial number.

Write them in the space below so that they are readily available when needed.

Type of unit : _____

Serial number : _____

Wiring diagram : _____

Year of manufacture : _____

<div style="display: flex; justify-content: space-around; align-items: center;"> <div style="border: 1px dashed black; padding: 5px; font-weight: bold; font-size: 1.2em;">LOGO</div> <div style="font-size: 2em; font-weight: bold;">CE</div> </div>	
<small>TIPO TYPE/TYP TYPE/TIPO</small>	
<small>NUMERO MATRICOLA SERIAL NUMBER / SERIENNUMMER NUMERO DE SERIE / NUMERO DE SERIE</small>	
<small>ANNO DI FABBRICAZIONE YEAR OF MANUFACTURE / BAUJAHR ANNEE DE FABRICATION / AÑO DE FABRICACIÓN</small>	
<small>REFRIGERANTE REFRIGERANT / KÄLTEMITTEL REFRIGERANT / REFRIGERANTE</small>	<small>GRUPPO (PED) GROUP / GRUPE GRUPE / GRUPO</small>
<small>CARICA REFRIGERANTE REFRIG. CHARGE / KÄLTEMITTELFÜLLUNG CHARGE REFRIG / CARGA REFRIG.</small>	<small>Kg</small>
<small>TENSIONE VOLTAGE / SPANNUNG TENSION / TENSION</small>	<small>V/Ph/Hz</small>
<small>F.L.A.</small>	<small>A</small>
<small>F.L.I.</small>	<small>kW</small>
<small>SCHEMA ELETTRICO WIRING DIAGRAM / SCHALTPLAN SCHEMA ELECTRIQUE / ESQUEMA ELÉCTRICO</small>	
<small>PRESSIONE MASSIMA ESERCIZIO MAX OPERATING PRESS. / MAX BETRIEBSDRUCK PRESS. DE SERVICE MAX / PRESION DE EJERCICIO MÁX</small>	
<small>CATEGORIA PED PED CATEGORY / PED KATEGORIE CATEGORIE PED / CATEGORIA PED</small>	<small>PS H/L bar</small>
<small>TEMP.LATO BP TEMPERATURE ON LP SIDE / TEMP. ND-SEITE TEMP. COTE BP / TEMP. PARTE BP</small>	
<small>INDIRIZZO / ADDRESS / ADRESSE / ADRESSE / DIRECCION</small>	

GENERAL WARNINGS

MANUAL PURPOSE

This manual has been designed to enable the unit to be installed, started up and maintained correctly.

MANUAL INSTRUCTIONS

It is essential to observe these instructions.

The manufacturer declines all liability for any damage that may be caused whether directly or indirectly to persons or things if these instructions are not heeded.

MANUAL STORAGE

This manual and the unit's wiring diagram should be carefully stored so that they are readily available to the operator when required.

EXPERT PERSONAL

The unit must be installed, tested and maintained by expert personal who meet the relevant legal requirements (Italian law No. 46 of 5/3/1990).

LOCAL SAFETY REGULATION INSTALLATION

The installation must be performed observing the local safety regulations.

POWER SUPPLY

Make sure the power supply conforms to the data on the unit's rating plate, located inside the door of the main electrical panel.

PACKAGING

The packaging material (plastic bags, polystyrene foam, nails, etc.) is potentially dangerous and should therefore be kept away from children and recycled in compliance with the local regulations in force.

MAINTENANCE

Before performing any service operations, cut off the power. Perform the operations in conformity with the local regulations in force.

PERIODICAL INSPECTIONS

Perform periodical inspections to locate possible loosened or broken parts. If the repairs are not performed, there will be a higher risk for things and peoples to become damaged and injured.

FAULT – POOR OPERATION

Switch off the unit in the event of faults or poor operation.

REPAIR

Only have repairs carried out by a service centre authorised by the manufacturer, and insist on the use of original spare parts only.

Failure to comply with the above may compromise the safety of the unit.

MODIFICATIONS

The manufacturer will not accept any responsibility, and the warranty will lapse, in the event of electric and/or mechanical modifications. Any modification which is not formally authorized, and which does not respect the instructions given in this manual, will cause the warranty to lapse.

INTENDED USE

The unit must only be used for the specific purpose it was designed :

The unit is designed to cool water or a water and glycol mix for air-conditioning, within the limits defined in the technical bulletin and this manual.

Any use other than that specified does not imply any commitment or constraint by the manufacturer in any way whatsoever.

ADDITIONAL SAFETY PRECAUTIONS

This unit has been especially designed and manufactured so to prevent any risk to persons and health hazard.

For this reason, design solutions fit to eliminate (where possible) any cause of risk and sensibly reduce the probability of danger have been adopted.

Please refer to the "Residual Risks" section of this manual and strictly observe the behaviour prescriptions listed there in order to prevent any possible risk that hasn't been possible to avoid in the design stage.

DATA UPDATING

The manufacturer may be able to modify the data without prior notice as a consequence of constant improvements.

REGULATIONS AND CERTIFICATIONS

UNI EN ISO 9001 CERTIFICATION

Clivet S.p.A., in order to guarantee customer satisfaction, has chosen the ISO 9001 Quality System as the reference for all its business activities. This is demonstrated by the company's commitment to ongoing improvements in the quality and reliability of its products; its sales, design, purchasing, production and after-sales service activities are the means used to reach such purpose.

CE MARK



Clivet products bear the CE mark, in compliance with the requirements of the following EC directives, including the latest amendments, and with the corresponding national approximated legislation:

- - 98/37/CE
- - 89/336/CEE as modified by the directives 92/31/CEE and 93/68/CEE
- - 73/23/CEE as modified by the directive 93/68/CEE
- - 97/23/CE

EUROVENT CERTIFICATION



Clivet is participating in the EUROVENT Certification Programme "Liquid Chilling Packages". Products are listed in the EUROVENT Directory of Certified Products and in the site www.eurovent-certification.com. Eurovent Chillers Certification Programme covers air cooled packaged chillers up to 600 kW and water cooled packaged chillers up to 1500 kW.

RESIDUAL RISKS

GENERAL

This section lists some of the more common situations which, being beyond the control of the manufacturer, could be a source of risk to persons or property.

DANGER AREA

The figure below highlights the area in which only authorised personnel may operate.

- **External danger zone**, identified by a precise area around the unit and its vertical projection on the ground in the case of hanging unit.
- **Internal danger zone**, identified by the area that can be entered only after having intentionally removed the protecting panels or parts of these.

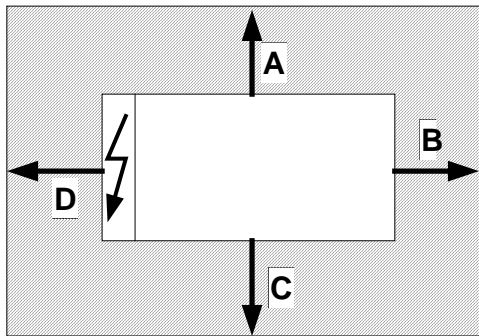

A = 2000mm B = 2000mm
C = 2000mm D = 2000mm

HANDLING

If handling operations are undertaken without adopting all the necessary safety procedures and exercising due care, the unit can fall or topple, causing damage — possibly extremely serious — to persons and/or property, and to the unit itself.

Ensure the unit is handled and manoeuvred as directed on the packing and in the present manual, and in accordance with local regulations.

In the event of refrigerant gas escaping, refer to the “Safety datasheet” for the particular refrigerant.

INSTALLATION

Incorrect installation of the unit can result in water leaks, accumulation of condensate, escape of refrigerant, electric shocks, fire, as well as irregular operation or damage to the unit itself.

Make certain that the installation is carried out only by a qualified technician, also that the directions contained in this manual are followed and local statutory regulations observed.

In the event of the unit being installed in a site where there is even the slightest risk of inflammable gas escapes and consequently the possibility of such gases accumulating in area around the unit, the risk of explosion and fire cannot be discounted.

Take every care and precaution when selecting the installation site.

Installation on a structure not able to bear the weight and/or afford a secure anchorage of the equipment may cause the unit to fall and/or topple, resulting in damage to persons or property, or to the unit itself. Make certain that every care

and precaution is taken when positioning and securing the unit.

If the unit is easily accessible to children, unauthorized persons or animals, this is a situation that can give rise to accidents and injuries, perhaps serious. Install the unit in a place where access is allowed only to authorized persons, or install barriers or guards preventing unauthorized entry.

GENERAL RISKS

A smell of burning, smoke or other indications of serious irregularity could signal the onset of situations liable to cause damage to persons or property or to the unit itself. Isolate the unit from the electrical power supply (red-and-yellow) switch.

Contact an authorized service centre so that the source of the problem can be identified and remedied.

Accidental contact with heat exchange coils, compressors, pressure pipelines or other components can result in wounding or burns, or both.

Always wear suitable clothing, including protective gloves, when working in the danger area.

Maintenance or repairs carried out by unskilled operatives can result in harm or damage to persons and property, or to the unit itself. Always contact an authorized service centre.

Failure to close the panels of the unit, or to check that all the fixing screws of the panels are properly tightened, can result in harm or damage to persons or property, or to the unit itself.

Verify periodically that all panels are closed and made properly secure.

In the event of fire, the temperature of the refrigerant can rise to the point that pressure will exceed safety levels and perhaps cause fluid to be projected. It may also happen that parts of the circuit isolated by closed valves will explode.

Do not stand near safety valves, and never leave the valves of the refrigerant circuit closed.

ELECTRICAL SYSTEM

If the power line connecting the unit to the a.c. supply is incomplete, or if the connection is made with cables of incorrect cross section and/or with insufficiently rated protective devices, this can result in electric shock, toxicity hazard, damage to the unit or fire.

All work on the electrical system should be carried out referring to the wiring diagram and to the directions given in this manual, and the system itself must be dedicated.

Failure to secure the cover enclosing electrical components can lead to the infiltration of dust and water, ultimately causing electric shocks, damage to the unit, or fire.

Always fasten the cover securely to the unit.

If live metal parts of the unit are not connected properly to the earth system, they can cause electric shock or even death by electrocution.

Make absolutely certain that the connection to the earth system is made in accordance with correct practice.

Contact with live parts rendered accessible internally of the unit when the guards are removed can result in electric shock, burns or death by electrocution.

Before exposing these parts, make certain the isolating switch on the power line to the unit is set to the OFF position and padlocked, and post a warning sign.

Contact with parts that could become live when the unit is started up can result in electric shock, burns or death by electrocution.

When there is no need for circuits to be powered up, set the isolating switch on the power line to the OFF position, padlock it and post a warning sign.

MOVING PARTS

Contact with the fan rotors can cause injury.

Before removing the protective grilles or the fans themselves, make certain the isolating switch on the power line to the unit is set to the OFF position and padlocked, and post a warning sign.

Before removing the protective grilles or the fans themselves, make certain the isolating switch on the power line to the unit is set to the OFF position and padlocked, and post a warning sign.

REFRIGERANT

In the event of safety valves coming into operation and releasing refrigerant gas, persons in the vicinity can be

injured or suffer toxic effects. Always wear suitable clothing and protective goggles when working in potential hazard areas.

In the event of refrigerant gas escaping, refer to the "Safety datasheet" for the particular refrigerant.

If an open flame or heat source is brought into contact with the refrigerant, or the pressurized gas circuit should overheat (e.g. during welding operations), this can cause explosion or fire. Do not position any heat source within the hazard area.

Maintenance or repair operations involving welding must be carried out with the system emptied of refrigerant.

WATER SYSTEM

Defects affecting pipelines, connections or valves and other control componentry can result in water being leaked or sprayed from the system, occasioning damage to property or causing short circuits in the unit.

Make certain all hydraulic connections are securely made, following the directions given in the present manual.

01	Identifying elements for the substance	Product name: forane 134a N°SDS 00941 Supplier: ELF ATOCHEM ITALIA Via Degli Artigianelli 10, 20159 Milano tel. 02/668111
02	Information concerning composition of components	Chemical name of the compound 1.1.1.2 - tetrafluoroethane General name: halogenated hydrocarbon CAS: 811-97-2 EINECS: 212-377-0
03	Identification of risk	Effects on health: practically non-toxic Greatest physical and chemical dangers: Thermal decomposition in toxic and corrosive products
04	First-aid measures	Inhalation: Carry the victim into the open air. Resort to oxygen or artificial respiration if necessary. Contact with skin: Frostbite must be treated in the same way as burns. Contact with the eyes: Immediate rinsing in abundant water. Instructions for the physician: Do not administer catecholamine (due to the sensitisation provoked by the product)
05	Fire prevention measures	Specific dangers: Thermal decomposition into toxic and corrosive products. Hydrofluoric acid. Hydrochloric acid in gaseous form. Phosgene Carbon monoxides (CO). Specific means of intervention: Cool containers/cisterns with jets of water. Prevent any sparks or flames. Do NOT smoke. Special protection systems for fire-fighting squads: Carry breathing apparatus and wear protective clothing.
01	Identifying elements for the substance	Product name: forane 134a N°SDS 00941 Supplier: ELF ATOCHEM ITALIA Via Degli Artigianelli 10, 20159 Milano tel. 02/668111
06	Measures to take in case of accidental spillage	Individual precautions: Avoid contact with the skin, eyes and inhalation of vapours. In an enclosed space: ventilate or use breathing apparatus (risk of suffocation). NO SMOKING ALLOWED. Remove all risk of sparks or flames.
07	Manipulation and storage	Manipulation: Technical measures/precautions. Form of storage and manipulation applicable to the products: PRESSURIZED GAS. Ensure adequate ventilation and evacuation for the level of equipment. Advice for use: Prevent sparks and contact with hot surfaces. DO NOT SMOKE.. Storage: Technical measures/Storage procedures: Store at room temperature in the original container. Keep away from flames, hot surfaces and sparks. Store in a cool, well-ventilated place. Protect full containers from sources of heat to avoid excessive pressures. Packing: Recommended: Ordinary steel, Stainless steel. Avoid: Alloy containing more than 2% magnesium. Plastics.
08	Control of individual exposure/protection	Precautionary measures to be taken: Ensure a sufficient exchange of air and/or suction in workplaces. Control parameters. Exposure limits: recommended by ELF ATOCHEM: VME = 1000ppm=4420mg/m ³ Individual protective equipment: Respiratory protection: In case of insufficient ventilation, carry suitable breathing apparatus. Protection for the hands: Gloves Protection for the eyes: Protective eyewear. Specific hygiene measures: avoid contact with the skin, eyes and inhalation of the vapours. DO NOT SMOKE.

09	Physical and chemical properties	<p>Physical state (20°C): liquid gas Colour: colourless Smell: Slightly similar to ether; pH: not applicable. Boiling point/interval: -26,4°C Melting point/interval: -101°C Flash point: No flare up at test conditions Self-ignition temperature: 743°C (1bar) 215°C (3bar) Vapour pressure: (25°C):0.665MPa (6.65bar) a (50°C):1.32MPa (13.2bar) a (70°C): 2.12MPa (21.2bar) Vapour density: (25°C): 4.26kg/m³ Density: (25°C): 1206kg/m³ a (50°C): 1102kg/m³ a (70°C): 996kg/m³ Solubility: water: (25°C): 0,9g/l Distribution coefficient: log Pow = 1.06 (n-octanole/water) Other data: Henry constant: 1.53Pa m³/mol Not dissociated in water Solubility of water in the product at 25°C: 0,097% in weight. Critical temperature: Tc=101°C Critical pressure. Pc=4.07MPa (40.7bar)</p>
10	Stability and reactivity	<p>Conditions to avoid: Avoid contact with flames and red-hot metal surfaces. Dangerous decomposition products: Thermal decomposition into toxic and corrosive products: hydrofluoric acid, hydrochloric acid in gaseous form, phosgene, carbon monoxide (CO) Other information: Stable product at ambient temperature. In presence of air the product can mix up into a flammable blend at particular temperature and pressure conditions.</p>
11	Toxicological information	<p>Acute toxicity: Inhalation: Practically non-toxic in experiments conducted on animals. CL50/inhalation/4 hrs/on rats>500000ppm As with other volatile aliphatic halogenated compounds, with the accumulation of vapours and/or the inhalation of large quantities, the product can cause: loss of consciousness and heart problems aggravated by stress and lack of oxygen; risk of death. Local effects: Contact with skin: Frostbite possible from splashes of liquefied gas. Practically non-irritating for skin in experiments conducted on animals (rabbits). Contact with the eyes: practically non-irritating for eyes in experiments conducted on animals (rabbits). Sensibilisation: Contact with skin: Experimental for the animal: No skin sensitizer (guinea pig). Chronic toxicity: Studies on animal protracted inhalation do not highlight any chronic toxic effect (rat/ years(s)/ Inhalation: 50000ppm) Specific effects: Genotoxicity according experimental available data NOT Genotoxic Cancerogenesis: experiments on animals do not highlight carcinogen effect clearly demonstrated (rat /Inhalation – for oral administration) Toxicity for reproduction: Foetal growth no toxic effect for foetal development (rat/rabbit/inhalation). Fertility, according the available data on animal: no toxic effects on fertility (rats/inhalation)</p>

This document refers to the product as is and which conforms to the specifications supplied by ELF ATOCHEM. If combinations or mixtures are made, check that there are no new dangers resulting from this action. The information provided in this report has been provided in good faith and is based on our latest knowledge of the product in question as of the date of publication of the same. The attention of users is drawn to the potential risks of employing the product for any use other than that for which it is intended. This report must be used and reproduced solely for purposes of prevention and safety. The list of legislative, regulatory or administrative texts must not be considered exhaustive. The product user is under obligation to refer to all the official texts concerning the use, conservation and manipulation of the product for which he is sole responsible. The product user must also provide all those who might come into contact with the product with the information necessary for their safety at work and the protection of their health and that of the environment, giving them a copy of this safety information report.

RECEPTION

INSPECTION UPON RECEPTION

Check on arrival that the unit has not suffered damage during transit and that it is complete in every part as specified in the order. In the event of visible damage/deficiencies being discovered, make a note immediately on the delivery document with the comment: **CONDITIONAL ACCEPTANCE — CLEAR EVIDENCE OF DEFICIENCIES/DAMAGE DURING TRANSIT**

Inform both the supplier and the carrier of the details by fax and by registered mail with advice of receipt not later than 8 days after taking consignment. Notifications sent after 8 days have elapsed will be ignored.

STORAGE

Shelter from: direct sunlight, rain, sand and wind

Temperature: maximum 60°C minimum -10°C

Maximum humidity: 90%

The respect of the instructions on the exterior side of the packaging assures the physical and functional integrity of the unit for the final user's advantage.

It is recommended to:

- Handle carefully
- Keep in a dry place
- Avoid putting other objects on top of the unit (respect the limits of levels of superimposition shown in the package)
- Avoid placing the unit with thermoretractable protection under the sun since the pressure of the circuits can assume values which activate the safety valves.

HANDLING

The operation of handling the unit must be carried out respecting the instructions of the safety norms in force (Legislative Decree 626/94 and following modifications)

Before starting the handling operations:

- Value the critical points during handling (stairs, flights, disconnected routes, doors, etc)
- Verify that the lifting capacity of the means used is adequate to the unit weight
- Consider that the barycentre could be moved with respect to the center of the unit
- Before starting to lift, verify that the unit is at a stable balance

The following examples are indications; the choice of the means and of the handling modes will depend on factors, such as:

- The unit weight
- Type and overall dimensions of the unit
- Place and route for the handling (dirt yard, asphalted square, etc)
- Condition of the place of destination (roof, square, etc)
- Handling distance characteristics (distances, flights, steps, doors)

LABELS / YELLOW BRACKETS SHOW THE LIFTING POINTS

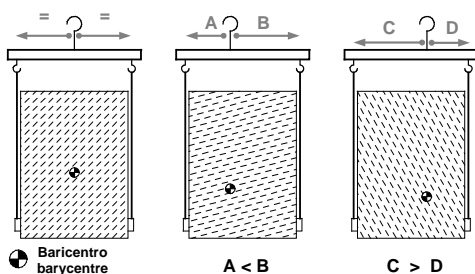

How to balance the charge
Move the upper hook or the lower hooks, according to the spring equalizer rocker arm type

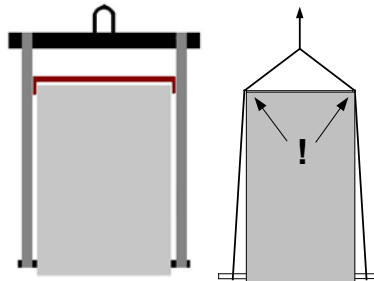

use a spacer bar
to avoid damaging the unit

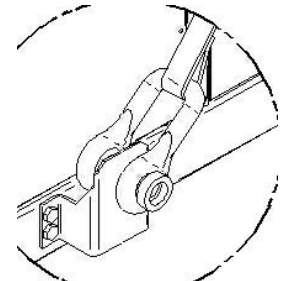

Lifting bracket

Depending on the type of unit, the holes and/or the brackets for lifting may be located in different places

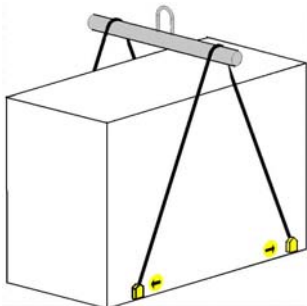

2 lifting points
use 2-arm uprights
(2 slopes/chains/slings per each side of the unit)

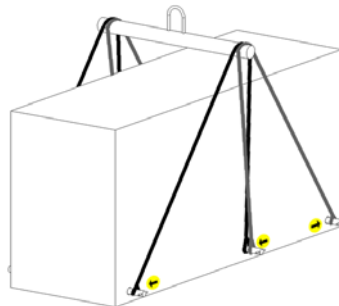

3 lifting points
use 3-arm uprights
(3 slopes/chains/slings per each side of the unit)

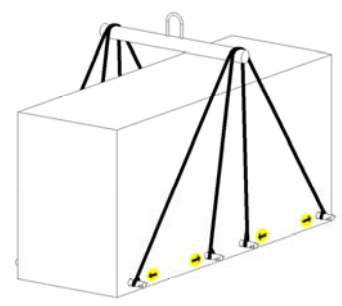

4 lifting points
use 4-arm uprights
(4 slopes/chains/slings per each side of the unit)

REMOVING THE PACKING

For removing the packaging, use specific personal protection for the operator (gloves, glasses, etc.). While removing the packaging, pay attention not to damage the unit.

Check for any visible damage.

Dispose of the packaging by taking it to specialist collection or recycling centres in accordance with local regulations.

POSITIONING

GENERAL

For installing air-conditioning systems, it is necessary to consider the following:

- the technical spaces necessary for the machine and system
- the place where the machine will be installed
- the transport of thermal carrier fluids and relevant connections to the unit:
 - water
 - air
 - refrigerant (unit in more sections)
- electrical connections

If these aspects are not evaluated carefully, they can affect the performances and the working life of the unit.

FUNCTIONAL CLEARANCES

When placing the unit, please respect the functional clearances indicated in DIMENSIONS section.

The functional spaces need to be observed because of the following:

- to guarantee the good operation of the unit
- to allow the performance of all maintenance operations
- to protect the authorized operators and exposed people

If more units are placed close to one another, the functional spaces must be doubled.

POSITIONING

1. The units are designed for **OUTDOOR / INDOOR** installations, performed in fixed positions and in areas accessible only to qualified and authorized personnel
2. **SAFETY VALVE** (only if present on the unit) : the installer is responsible for evaluating the opportunity of installing drain tubes, in conformity with the local regulations in force (EN 378)
3. Install the unit **raised** from the ground
4. avoid installations in places subject to **flooding**
5. Consider the maximum level which can be reached by **snow**
6. Verify that the fixing/supporting points are level and suitable to support the **weight of the unit** (see the weight and the weights distribution)
7. It is recommended to put the unit on specific **antivibration devices**

Each support point of the unit sustains a different weight. Therefore, each anti-vibration device is sized for a specific support point, and can only be placed there. The anti-vibration devices must therefore be placed in accordance with the instructions provided with them and with the dimensional drawings in which the support points are indicated by W1 , W2 , W3 etc .

On each anti-vibration device (if provided by CLIVET), its identifying code is stamped, for example C6100100

Flexible joints are necessary on all the hydraulic/aerualic connections (the joints are not supplied by Clivet)

8. **Anchor** the unit to the ground; foresee windbreak barriers in case of places where there are strong prevalent winds .
9. The choice of the location of the unit is of fundamental importance for correct operation; to avoid:
 - **obstacles** that block the flow of air
 - difficulty in air **circulation**
 - **leaves** or other objects that may block the exchanger coils
 - **winds** that contrast or excessively assist the air flow
 - phenomena of **stratification** or air **re-circulation**
 - nearby **sources** of heat (chemney, extractor ecc)
 - positioning under the round level or near very high walls

The previous situations cause working anomalies or stop the machine and cause:

- during **SUMMER** operation, increase of the condensation pressure with the decay of performances and possible stops due to high pressure.

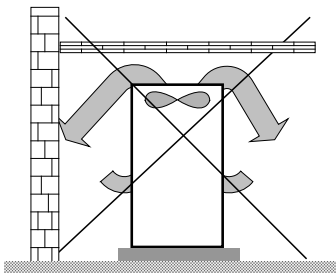

Consider clearances and direction of expelled air.

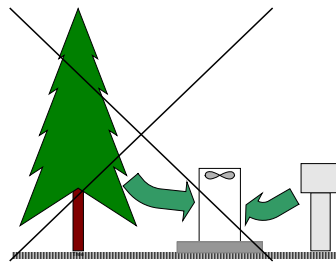
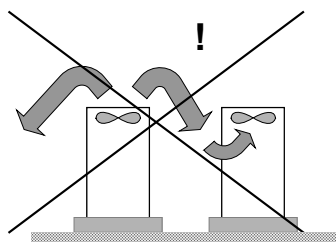

Keep the coil clean. Avoid zones with leaves / dirt / corrosives.

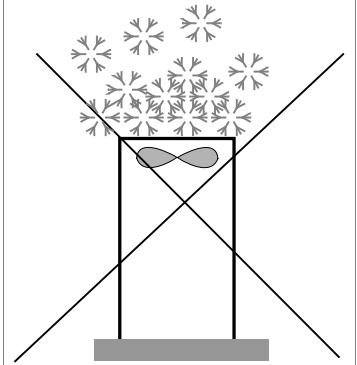

Avoid snow build-up during winter operation

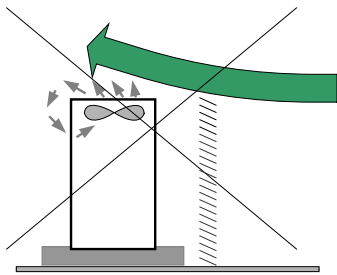

Provide windbreaks in locations with strong winds.

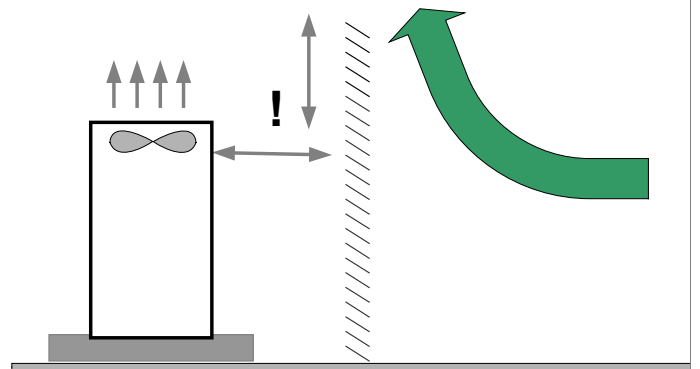

INSTALLATION OF ANTIVIBRATION MOUNTS

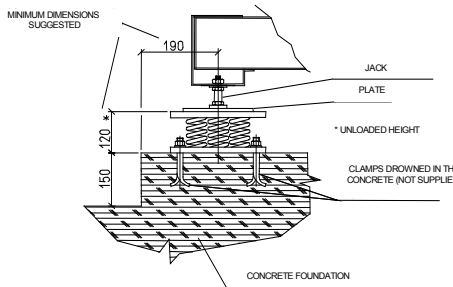

with jack for unit levelling

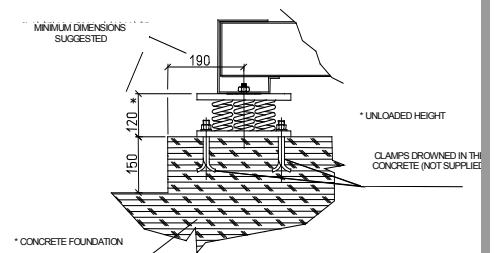
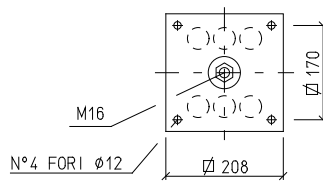

with supported frame

WATER CONNECTIONS

GENERAL

Piping must be designed with the least possible number of bends and head variations. If the pressure chute of the installation is above the useful prevalence of the pump, the water delivery capacity is reduced as well as, as a consequence, the thermal exchange and the yield.

INTERCEPTING VALVES

Install on the input and output of the user parts (exchangers, coils, humidifiers, etc) So that it will be possible to carry out all the service operations and possible substitutions without emptying the installation.

PRESSURE AND TEMPERATURE INDICATOR

Install on the input and output of the user parts (exchangers, coils, humidifiers, etc) So that it will be possible to carry out all the service operations.

AUTOMATIC OR MANUAL ESCAPE VALVES

Install the highest points of tubes in a way that the air can escape from the circuit.

BLEEDING COCK

Install them at the lowest points of the circuit, so as to allow emptying.

LEAKAGE TESTS

Before performing the insulation of the tubes, carry out a leakage test.

TUBE INSULATION

All tubes of water must be insulated so that to avoid the formation of condensation and thermal dispersions along the tubes themselves. Verify that the insulation is the vapour coil type. The connections for the air escape and for the emptying must be out of the insulating thickness to assure the accessibility.

CONNECTIONS SUPPORTS

The weight of the hydraulic connections must be supported in the exterior of the unit so as not to stress the connections of user devices (exchangers, coils, humidifiers, etc) .

ANTI-VIBRATION DEVICES

In case of units with anti-vibration devices, it is necessary to assemble elastic joints, even on water connections.

RISK OF FREEZE

If the unit and the relevant water connections are subject to temperatures near 0°C:

- mix the water of the system with glycol
- protect the tubes with heating cables under the tubes insulation
- empty the system by verifying that:
 - no taps are closed so they can not trap the water, even after emptying
 - there are no low points where the water can stagnate even after emptying; blow if necessary

INSTALLATION EMPTYING

The refilling of the water present in the installation increase the oxidation phenomena and lime deposits.

If necessary empty only the interested system section and anyway empty or refill the installation if necessary .

EXPANSION TANK

The installation must be kept at the right pressure by both an expansion tank and a combined valve of pressure reduction and discharge; if the components are present on the unit, they must be installed on the installation. The expansion tank must be dimensioned in function of the water in the installation.

ARIES EFFECTS AND AIR BUBBLES CAN PRODUCE THE OVERCOMING AND CAUSE WATER DROPS.

EXCHANGER USE SIDE

FILTER

It is very important for the water to be free of impurities. If it is not, the efficiency of thermal exchange is diminished. In worst cases, the exchanger can be irreparably damaged. If the filter is not present on the machine, it must be immediately installed upstream from the unit, in a position which can be easily reached for cleaning.

The filter mesh must be :

- < 1 mm unit with 1 compressor
- < 1.5 mm multicompressor unit.

FLOW SWITCH

The flow switch must be present as a component of the system, so as to ensure shutdown of the unit if water is not circulating. It must be installed in a straight tract of the tubes, not near the elbows, which can generate harmful turbulence.

UNFREEZABLE LIQUIDS

If the unit is used when the water temperature is lower than + 4°C, avoid the formation of ice by using unfreezable liquids (ex. Ethilenic Glycol) in the necessary percentage. The use must also be determined for ambient temperatures near 0°C .

ANTIFREEZE RESISTANCES

If the unit is equipped with antifreeze resistances on the exchanger side (standard or optional according to the models), verify that they are electrically fed during periods that the machine is stopped (night, weekends, long stops)

WASHING THE SYSTEM

Carefully wash the system by using clean water and discharge it before connecting the unit.

DIAGRAM OF RECOMMENDED USE SIDE CONNECTION

Depending on the type of machine and the selected setup, some components may be integrated into the unit.
The accumulation tank is necessary in the event of the following:

- the water in the system is very low
- the unit will not be used in a private house (in an industrial process or other)

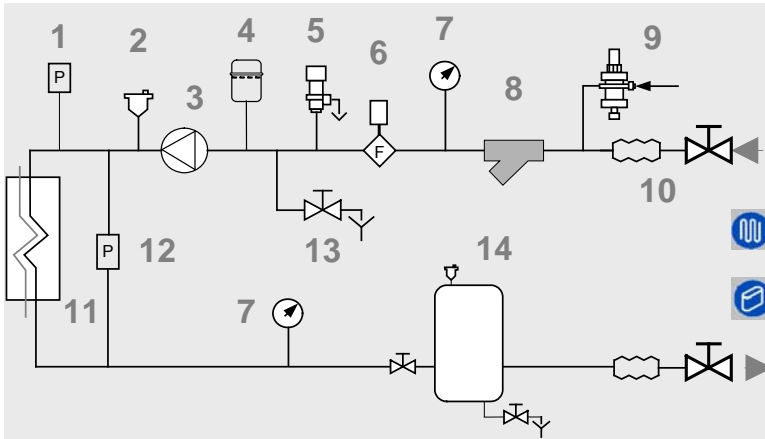

1. Charged system pressure switch
2. vent
3. circulating pump / pump
4. expansion tank
5. safety valve
6. flow switch
7. pressure switch / thermometer
8. filter
9. filling valve
10. antivibration joints
11. user side exchanger
12. Differential pressure switch
13. Discharge cock
14. inertial storage tank

FREE COOLING - optional

To prevent the RISK OF FREEZING load the free-cooling coils and the corresponding hydraulic system with a glycolic water solution.

The glycol percentage must be defined according to the min. temperature reachable in the installation place.

RECOVERY EXCHANGER - OPTIONAL

OPTIONAL - The unit can be equipped with exchangers to allow the recovery:

TOTAL, with 100% recovery of the condensation heat the thermoregulation is performed by CLIVET control system.

PARTIAL, with 20% recovery, the management is supplied by the customer (pump, valves, thermostats, etc: see the following diagrams)

The recovery input water must not be below 25°C, in the event that, wrongful operations and breakages of the unit can occur.

Water connections must be performed carefully as for the evaporator (filter, circuit washing, etc) .

Perform all necessary interventions to avoid the RISK OF FREEZING (tubes insulation, emptying of circuit, addition of glycol, anti-freeze resistances) .

Water temperature can reach high temperatures (up to 100°C), therefore:

- avoid the RISK OF BURNS by adopting the necessary precautions (insulation of tubes, temperature detecting station on water if the sanitary use is foreseen, etc)

Install safety valves and specifically dimensioned expansion tanks in the hydraulic circuit.

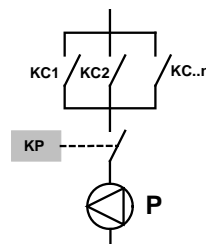
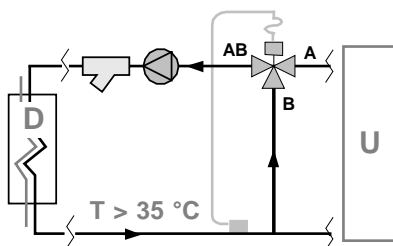

D : desuperheater

U : use

KC1..n : contacts of compressor contactors

VICTAULIC CONNECTIONS

1. Take away the supplied connection union by acting on the connection joint Victaulic.
2. Weld the union to the installation pipe.
3. Perform the connection between the installation pipe and the evaporator, using the joint.

Do not weld the system pipe with the Victaulic connection joint attached.

The rubber gasket might be irreparably damaged

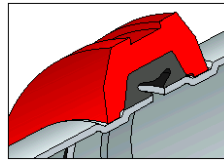

HYDROPACK - OPTIONAL

Self-adjustment: The modular pumping system makes it possible to automatically reduce the water flow rate if the temperature increases above the operating limit (excluding hydropack with 1 pump).

The device is also very useful during start-ups, on weekends and after a long period of inactivity.

When the temperature of water in the hydronic circuit is especially high, this prevents undesired shutdowns due to overload resulting in call-outs of service technicians to assist in restarting.

Furthermore, Hydropack allows a variable water capacity flow in the systems where this would be called for.

By equipping the refrigerating units with the Hydropack accessory, the necessary flow capacity/head are provided in different versions:

HYDROPACK with 2 pumps

Per less power units, the standard solution with 2 pumps can be chosen. If a pump gets blocked, the unit will go on working till about 60% of the charge. This solution is more reliable than the traditional ones with a single great power pump.

HYDROPACK with 3 pumps

for units of greater power; with the solution of 3 pumps which are always activated, the possible blocking of a pump always assures the regular working up to 80% of the charge (always with the signalization of the blocking). In this case, it is possible, upon request, to supply a reserve pump (not connected). The replacement is performed in few minutes time, thanks to the simple foreseen connections.

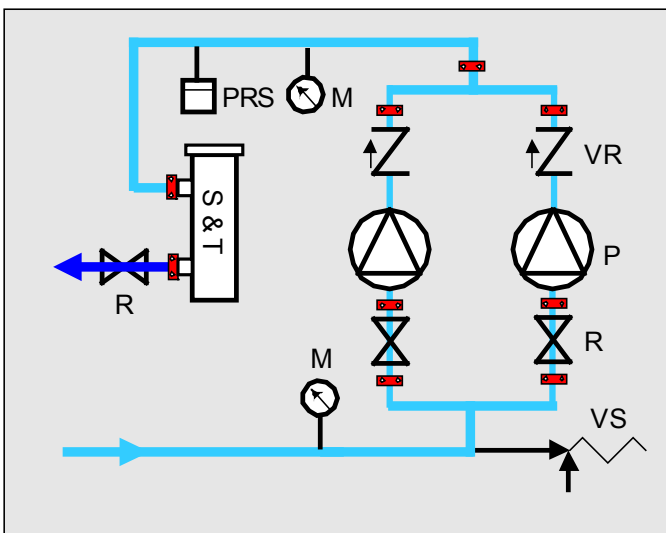

Multi pump hydronic group including:

- R = shut-off valves
- M = manometers
- VS = safety valve (6 Bar)
- P = high efficiency single-structure and single-rotor electric pumps
- VR = check valves
- PRS = safety pressure switch (avoids pumps operation in case of water absence)
- S&T = evaporator

ELECTRICAL CONNECTION

GENERAL

The characteristics of the electrical lines and relevant components must be determined by SPECIALIZED PERSONNEL ABLE TO DESIGN ELECTRICAL INSTALLATIONS; moreover, the lines must be in conformity with professional procedures and the regulations in force.

All electrical operations should be performed by trained PERSONNEL HAVING THE NECESSARY REQUISITES UNDER LAW and being informed about the risks relevant to these activities.

Before performing any operation on the electrical system, make sure that the unit supply line is SELECTED AT START.

The earth connection must be made prior to other electrical connections.

For all electrical type operations, REFER TO THE ELECTRICAL DIAGRAM ATTACHED TO THE UNIT; the number of the diagram is shown on the registration plate positioned on the electrical board or next to it.

The electrical diagram should be carefully kept together with this manual and should be AVAILABLE FOR FUTURE INTERVENTION ON THE UNIT.

LINE OF UNIT POWER SUPPLY

The ELECTRICAL DATA OF THE UNIT are shown in the technical chart of this manual and on the unit registration plate. The presence of accessories can vary according to

the unit; the electrical data shown in the technical chart refer to standard units. In the event of differences between the data of the registration plate and the data shown in this manual, as well as in the technical chart, please refer to the DATA SHOWN IN THE REGISTRATION PLATE.

The protection device of the unit power supply line should break off the short circuit power whose value should be determined according to the plant features.

The section of supply cables and protection cable must be seized according to the characteristics of the protections used.

SIGNALS / DATA LINES

Do not overpass the maximum power allowed, which varies, according to the type of signal.

Lay the cables far from power cables or cables having a different tension and that are able to emit electromagnetic disturbances.

Do not lay the cable near devices which can generate electromagnetic interferences.

Do not lay the cables parallel to other cables; cable crossings are possible, only if laid at 90°.

Connect the screen to the ground, only if there are no disturbances.

Assure the continuity of the screen during the entire extension of the cable.

Observe, if any, the requirements about impedance, capacity, attenuation.

STANDARD UNIT ELECTRICAL DATA

Acoustic configuration: Standard (ST) / Compressors insulation (SC)

Voltage: 400/3/50

Size	2.160	2.180	2.190	2.200	2.240	2.280	2.300	2.320	2.340	2.360	2.440	2.480	2.540	2.600	
F.L.A. - FULL LOAD CURRENT AT MAX ADMISSIBLE CONDITIONS															
F.L.A. - Total	A	304.1	332.7	367.1	393.3	438.9	488.5	520.8	553.1	593.1	624.9	722.3	829.9	921.3	1031.5
F.L.I. FULL LOAD POWER INPUT AT MAX ADMISSIBLE CONDITION															
F.L.I. - Total	kW	176	195	217.4	236	262.2	295.4	320.1	344.8	367.7	386.8	439.7	480.6	540	607.2
M.I.C. MAXIMUM INRUSH CURRENT															
M.I.C. - Value	A	717.2	731.5	572.6	598.8	678.6	703.4	716.4	748.7	845.8	877.6	1096.3	1431.1	1690.8	1745.9

The F.L.A. data is to be considered in order to correctly size the supply line, whereas the M.I.C. data is used for the sizing of the protection device up the line.

voltage unbalance: max 2%

power supply: 400/3/50 Hz +/-6%

Acoustic configuration: Low noise (LN) / Voltage: 400/3/50

Voltage: 400/3/50

Size	2.160	2.180	2.190	2.200	2.240	2.280	2.300	2.320	2.340	2.360	2.440	2.480	2.540	
F.L.A. - FULL LOAD CURRENT AT MAX ADMISSIBLE CONDITIONS														
F.L.A. - Total	A	286.1	319.3	347.8	376.3	413.7	463.3	500.2	532.5	573.5	605.3	686.3	803.1	878.1
F.L.I. FULL LOAD POWER INPUT AT MAX ADMISSIBLE CONDITION														
F.L.I. - Total	kW	169	190.4	210.2	230	252.4	285.6	312.7	337.4	361.3	380.4	425.7	471.4	523.2
M.I.C. MAXIMUM INRUSH CURRENT														
M.I.C. - Value	A	658.7	679.4	506.5	535	596.7	621.5	640.9	673.2	765	796.8	979.3	1326.9	1550.4

The F.L.A. data is to be considered in order to correctly size the supply line, whereas the M.I.C. data is used for the sizing of the protection device up the line.

voltage unbalance: max 2 %

power supply: 400/3/50 Hz +/-6%

CONNECTION TO THE MAINS

1. Make sure that the sectioning device at the beginning of the unit's power line is opened, locked and equipped with a signal.
2. Open the general line disconnecting switch (if present)
3. Verify that the net is in conformity with the data shown in the registration plate placed on the electrical board.
4. Check the dimensional drawing for the input of the electrical lines
5. Take away the closing plate placed on the electric board (ONLY IF PRESENT) and drill a hole through it to pass the cables through)
6. Protect the cables, using the fairlead of an adequate size.
7. Using the layout of the electrical diagram, single out the connecting terminals of the electrical supply cables, of the neutral (if foreseen) and the PE protection cable
8. Connect the cables to the relevant terminal boards
9. Before supplying power to the unit, make sure that all the safety devices that were removed during electrical connections are positioned again.

FUNCTIONAL CONNECTIONS

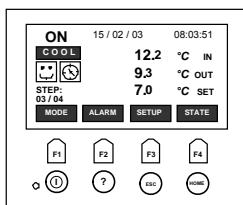

Use voltage-free remote control devices that are suitable to commutate very low loads (12V, 10mA)

Few inputs must be activated by configuration parameters whose access is reserved to authorized assistance centers (in order to avoid unauthorized modifications)

ON / OFF FROM REMOTE CONTROL

It allows the remote start and stop, not by keypad.

It can be used to disable the unit during the night, the weekend etc., so with ON or OFF periods relatively long (some hours).

It has not to be used with ON or OFF cycles too much short: they compromise the operating logic and they can cause malfunctions or faults. In summer operating, for example, ON -OFF cycles lower than one hour can compromise the thermoregulation logic, that implements an integral check.

If this function is not used, jump the respective terminals.

SIGNALIZATION OF MALFUNCTIONING/ UNIT FUNCTIONING

Remote signalization of the proper function (ex. green light) or signalization of blocks of the machine (ex. red light).

Maximum voltage at the terminal ends is 24v ac and maximum power is 5a (ac1)

SECOND SET-POINT

It allows the use of a secondary set-point, such as, for example, for a night operation, which can be activated by a remote contact.

When the contact is CLOSED, the secondary set-point is activated.

DEMAND LIMIT

It is possible to limit the absorbed electric power with an external signal of 10 Vcc or 4-20 mA. The higher the signal is, the lower the number of compressors available to meet the thermal need.

Only an authorised service centre can perform the parameter configuration.

MENU	NUM	Parameter name	meaning
thermoregulation-demandlimit	7	DmandLimitEn	Enables the function : <ul style="list-style-type: none"> • 0= disabled • 1=by signal • 2=by parameter
parameter-set-sensors	82	TypeDI	Type of signal : 0=0-10 V ; 1=4-20mA

FRESH AIR TEMPERATURE PROBE - Optional

It allows the automatic correction of the set-point according to the external air temperature.

For example, the summertime with low external temperatures, it is possible to have the internal comfort even with set-points higher than the standard.

The parameter configuration must be carried out by an assistance center.

MENU	NUM	Parameter name	meaning
parameter control compext	1	EnCompExt	External compensation enabling 0 = no; 1 = COOL only; 2 = HEAT only; 3 = always
	4	MaxCExtC	Max. ext. compensation value of cooling
	106	CextMaxC	Max. ext. temp. of cooling compensation
	107	CextMinC	Min. ext. temp. of cooling compensation
parameter-set-sensors	9	ProbeText	It enables ext. temp. probe: 0=yes ; 1=no

SUMMER

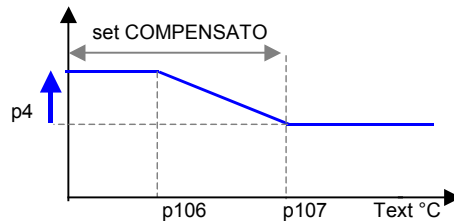

EXTERNAL AIR HUMIDITY PROBE - Optional

It allows the automatic correction of the set-point, according to external air enthalpy .

Nel funzionamento invernale la correzione avviene sulla sola temperatura.

The working process is similar to the above mentioned process . The parameter configuration is necessary.

MENU	NUM	Parameter name	meaning
parameters thermoregulation compext	4	MaxCExtC	Max. Summer correction value
	110	HexMinC	Min. correction ext. enthalpy
	111	HexMaxC	MAX. correction ext. enthalpy
parameter-set-sensors	23	ProbeURExt	Enables external humidity probe: 1=YES / 0=NO

WATER RESET - Opzionale

It allows the automatic correction of the set-point, according to an external signal of 4-20 mA or 0-10 vcc.

The working process is similar to the above mentioned process .

The parameter configuration is necessary.

MENU	NUM	Parameter name	meaning
parameter control waterreset	11	MaxCWRC	WR Summer correction max. value
	75	WaterReset	Water Reset enabling: 0 = no; 1 = COOL only; 2 = HEAT only; 3 = always
	105	SWRMaxC	Summer MAX correction signal
	108	SWRMinC	Summer MIN correction signal
parameter-set-sensors	83	TypeWR	Inlet signal type: 0=0-10V; 1=4-20mA

SUMMER

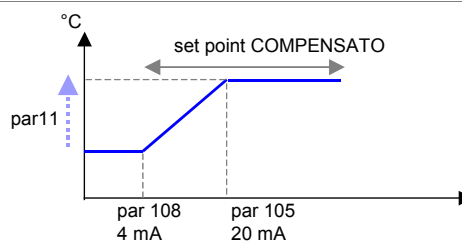

CLIVET TALK MODULAR SYSTEM COMPOSITION

CLIVET TALK system is made up of different modules connected to each other with the CAN OPEN protocol. The system configuration varies according to the typology of the unit and of the accessories: not always the represented electric modules are all presents on the unit.

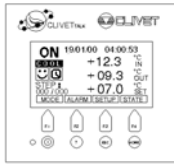

INTERFACE

code C5110821

The interface module allows for the control of the operations of the whole machine, the programming of the different adjustment parameters and also to display the alarms and the unit status.

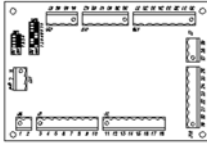

CENTRAL MODULE

code C5110694

The central module manages the system configuration, the working mode, the set point, the thermal adjustment, remote inputs.

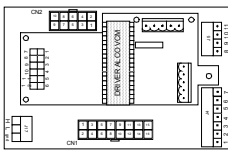

SCREW COMPRESSOR MODULE

code C5110801

It manages the cooling circuit (compressors, fans, valves) and relative safety devices.

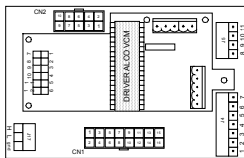

COMPRESSOR MODULE - TANDEM / TRIO

code C5110804 (tandem) – C5110801 (trio)

It manages the cooling circuit (compressors, fans, valves) and relative safety devices.

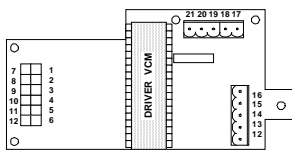

ELECTRONIC THERMOSTATIC EXPANSION VALVE MODULE

code C5110802

This manages the electronic thermostatic valve and the relative sensors for control of temperature/pressure.

It is installed above the compressor module

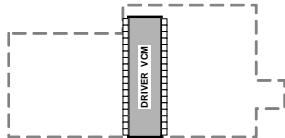

DRIVER MODULE

code C5110803

The electronic thermostatic valve management firmware is located here. It is mounted on the expansion valve module.

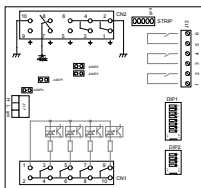

EVAPORATOR MODULE

code C5110674

It manages components, safety devices, inputs and outputs relative to the water circuit (pumps, differential manostat, temperature probes)

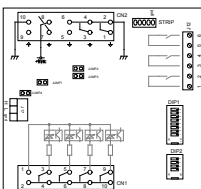

PUMP MODULE

code C5110701

It manages controls and safety devices relative to the circulation pumps

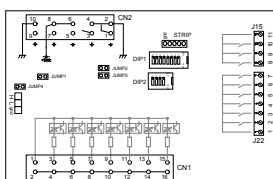

RECOVERY MODULE

code C5110679

It manages the electrovalves and the pumps relative to the recovery circuit.

REMOTE TERMINAL

cod PE1W0005

The remote keyboard has the same functions of the keyboard on board of the machine.

The connection of the remote keyboard to the system on board of the machine is carried out, using the "CAN to CAN" converter, which must be placed in the electric board of the machine

The REMOTE KEYBOARD must be configured with the software address = 27 (only an authorised service centre can perform this operation).

If the unit is managed by timetables, they must be activated only on one of the two keyboards of the machine, better if the remote keyboard.

CONNECTIONS: refer to the electric diagram and to the SIGNAL/DATA LINES paragraph

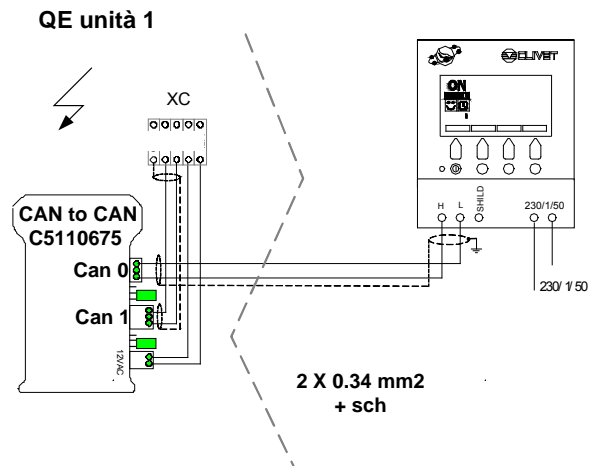

MODBUS - CONVERTER CAN TO MODBUS VIA RS 485

Interfacing via RS 485 is performed using a converter for each unit.

The converter must be mounted on the electric board of the unit and connected, following the electric diagram attached to the unit.

CONNECTIONS: refer to the electric diagram and to the SIGNAL/DATA LINS paragraph.

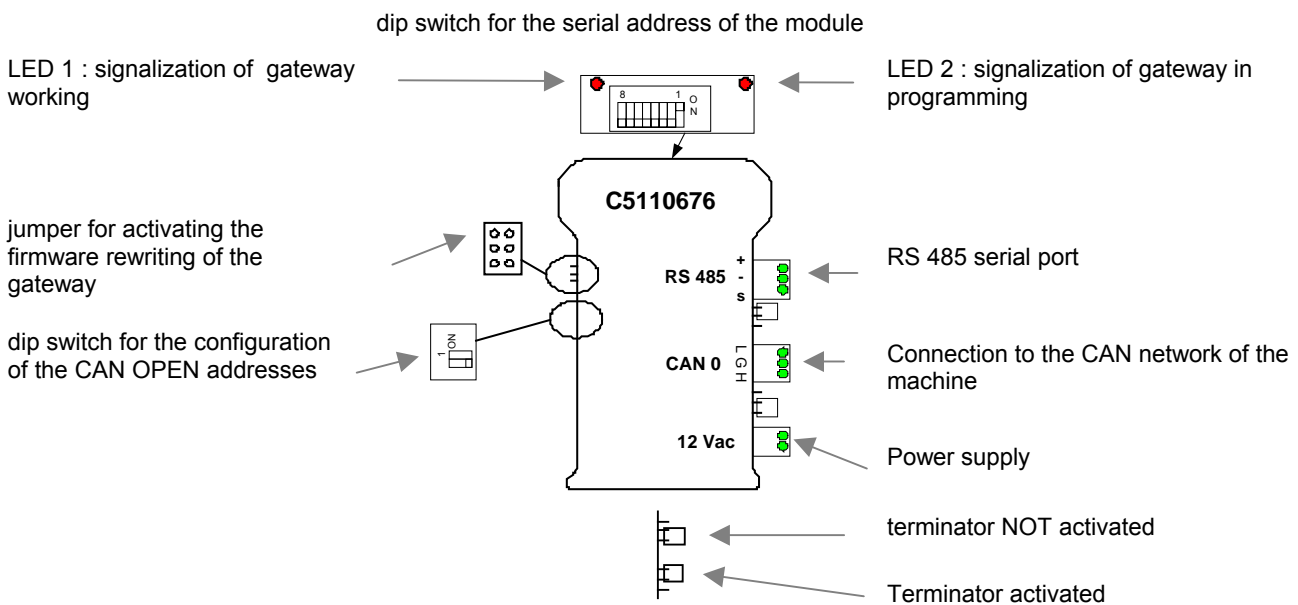

UNIT NETWORK – MINI NETWORK – MASTER SLAVE

The *CLIVET TALK Local Network* system allows to connect up to 6 machines in a network which all serve the same installation. To interact with the network which controls the working of the system, it is necessary to have a CAN to CAN converter code C5110692 for each machine.

Each single machine is equipped with the standard electronic devices: if necessary, it can function as an independent unit.

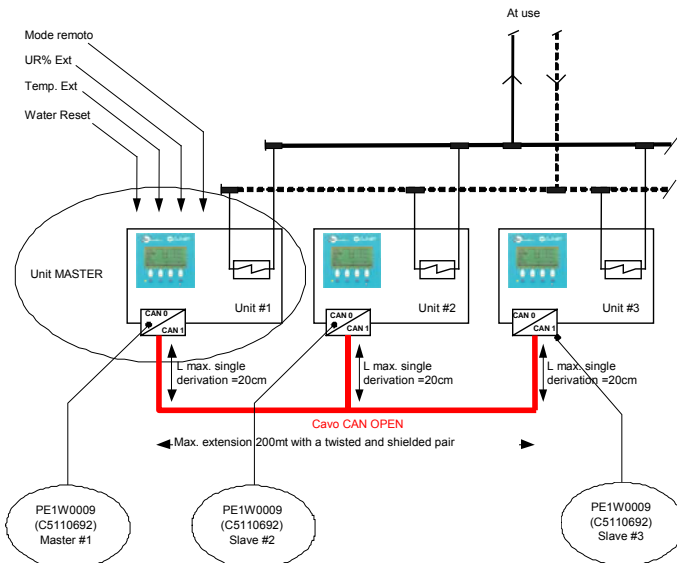

CONNECTION CABLE :

Section (nominal)	0.34mm ²
Heater	70mΩ/meter
Impedance	120mΩ/meter
Propagation delay	5nS/meter
Length MAX	200meters

DATALOGGER cod PE1W0006

CONNECTIONS : make reference to the electrical panel and to SIGNALS/DATA LINES paragraph

KIT LONWORKS

Upon request, the unit is equipped with the kit already mounted on the electric board; it can eventually be mounted later.

Refer to the electric diagram and to the LONWORKS MANUAL.

For information about cables for the Lonworks network, visit the web site www.echelon.com.

LONWORKS technology is a complete platform to implement the network system control. These networks consist of intelligent control instruments, or *nodes*, which interact with their environment and communicate to each other by using a common message based on the (*LonTalk*®) protocol. A LONWORKS network can have up to 32,385 nodes subdivided into 255 sub-networks (127 nodes/sub-network).

The Gateway device is already configured, according to the Echelon classification for the type of the unit it is designed for, with a number of managed variables, which is a sub-array of those managed originally by the machine and able to accept the Echelon standard profiles. The supply of this device does not include the activity of configuration and management of the LonWorks network to which it is connected; as usual, they are supplied by the Supervision System supplier.

CAN TO MODBUS

GATEWAY LON-WORKS

Signalization led of gateway in programming

Dip switch for setting the module serial address

Signalization led of gateway operation

jumper to activate the gateway firmware rewriting

terminator INSERTED

Dip switch configuration of CAN OPEN addresses

Terminator NOT ACTIVATED

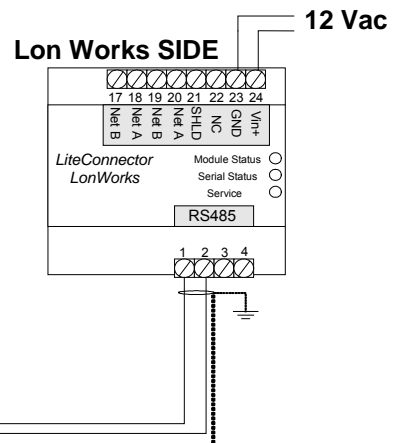

START-UP

ALL THE EQUIPMENT MUST BE COMMISSIONED BY AUTHORISED SERVICE CENTRES.
THIS SERVICE IS LIMITED TO START-UP OF THE UNIT ONLY AND NOT THE CONNECTIONS OR INSTALLATION OF THE SYSTEM.

ONLY QUALIFIED TECHNICIANS MUST PERFORM THE FOLLOWING OPERATIONS.

PRELIMINARY CHECKS

Before checking, please verify the following

1. the unit should be installed properly and in conformity with this manual.
2. the electrical power supply line should be sectioned at the beginning.
3. the sectioning device is locked and the proper warning "not to operate" sign is placed on the handle.
4. make sure no tension is present
5. the coils must be clean and free of obstacles
6. the ventilators must be free of leaves, cardboard, fixed obstacles (beams, barriers, etc.), snow, etc
7. the external ventilators must not be blocked

The external ventilators can be subject to a temporary block, especially if the inactivity period before the first start-up was quite long or if outside temperature is very low. It is also possible to unblock them manually (ONLY WHEN THE UNIT IS UNPLUGGED – RISK OF INJURES) so that jams or electric overloads are avoided when the unit is restarted.

REFRIGERANT SYSTEM

Carefully check the refrigerating circuit: the presence of oil stains can mean leakage caused by transportation, movements or other).

Open the cocks of the refrigerator circuit, if there are any.

Using the unit manometers, if present, or service manometers, verify that the refrigerating circuit is in pressure.

Make sure that all the service outlets are closed with proper caps; if caps are not present a leak of refrigerant can be possible.

WATER SYSTEM

Ensure that the plumbing system has been washed. Drain the wash water before connecting the unit to the system.

Check that the water circuit has been filled and pressurised.

Perform a seal check at max. working pressure checking that no leaks are present.

Check that the shut-off valves in the circuit are in the "OPEN" position.

Check that there is no air in the circuit. If required, bleed it using the vent valves in the system.

Check that there are no ARIES EFFECTS in the transient (pump and / or valve activation/deactivation)

When using antifreeze solutions, make sure the glycol percentage is suitable for the type of use envisaged.

% weight of ethylene glycol	10 %	20 %	30 %	40 %
Freezing point	- 4 °C	- 9 °C	- 15 °C	- 23 °C
Safety temperature	- 2 °C	- 7 °C	- 13 °C	- 21 °C

Check that the circulator pumps are not blocked. In fact, their motor shaft may seize up, especially after long shutdowns. Unblocking can be accomplished with a screwdriver using the purge hole.

ELECTRICAL SYSTEM

Check the proper tightening of the screws that fix the conductors to the electrical components in the board (during handling and transportation, the vibrations could have loosened them).

Verify that the unit is connected to the ground plant.

Control that all panels and protection devices of the unit are repositioned and blocked.

Charge the unit by closing the sectioning device, but leave it on OFF.

Make sure that the tension and net frequency values are within the limit of:

230 +/- 10% single phase unit; 400/3/50 +/- 10% three-phase unit

Control the unbalancing of the phases: it must be lower than 2% .

Example:

L1 - L2 = 388 V, L2 - L3 = 379 V, L3 - L1 = 377 V

average of the measured values = $(388 + 379 + 377) / 3 = 381$

maximum deviation from the average = $388 - 381 = 7V$

Unbalancing = $(7/381) \times 100 = 1.83\% = \text{ACCEPTABLE}$

Operating out of the indicated limits causes the loss of the guarantee as well as very serious damages.

IF THE CRANKCASE RESISTANCES ARE FITTED

when the unit is started up for the first time and following all prolonged periods of inactivity is OBLIGATORY to connect the oil resistances on the compressor crankcase at least 8 hours before the compressor is to be started.

BEFORE POWERING THE RESISTANCES, OPEN THE COMPRESSORS COCKS, IF PRESENT.

To supply the resistances is necessary to switch off the isolator switch on the unit.

To make sure that the resistances are working, check the power input with amperometric pliers.

At start-up the compressor crankcase temperature on the lower side must be higher at least of 10°C than the outside temperature.

DO NOT START THE COMPRESSOR WITH THE CRANKCASE OIL BELOW OPERATING TEMPERATURE.

VERIFY TENSIONS – ABSORPTIONS

Check that the temperatures of the fluids are included in the WORKING LIMITS.

If the controls of the previous paragraphs are positive, it is possible to restart the unit.

For information on the control panel, refer to the paragraph CONTROL.

While the unit is working (ATTENTION ELECTRIC RISK: WORK SAFELY) check:

- Power supply tension
- Phase unbalance
- Total absorption of the unit
- Absorption of the single electric loads

UNIT EQUIPPED WITH SCROLL COMPRESSORS

The GENERAL TECHNICAL DATA table shows the type of compressor on the unit.

The Scroll compressors have only one direction of rotation.

In the event that the direction is reversed, the compressor will not be damaged, but its noisiness will increase and pumping will be negatively affected. After a few minutes, the compressor will stop because of the activation of the thermal protection. In this event, cut the power and reverse the 2 phases on the machine power.

Prevent the compressor from working with in reverse rotation: more than 2-3 anomalous starts up can damage it.

Make sure the direction of rotation is correct, measure the condensation and suction pressure. Pressure must clearly differ: at the start, the suction pressure decreases whilst the condensation pressure increases.

The phase optional monitor, which controls the phase sequence, can be installed later.

REMOTE INPUT CONFIGURATIONS

Check used remote inputs are activated (ON-OFF etc.) as given in the instructions in the ELECTRIC WIRING chapter.

SETTING THE SET-POINT

Check if it is necessary to modify the set-points shown in the CONTROL chapter

EVAPORATOR WATER FLOW RATE

Check that the difference between the temperature of exchanger return and supply water corresponds to power according to this formula:

$$\text{unit cooling power (kW)} \times 860 = \Delta t \text{ (}^\circ\text{C)} \times \text{flow rate (L/h)}.$$

The cooling power is shown in the TABLE ON GENERAL TECHNICAL DATA included in this manual, referred to specific air/water conditions, or in the tables on cooling PERFORMANCE IN THE TECHNICAL BULLETIN referred to various conditions of use.

Check for water side exchanger pressure drops:

- Determine the water flow rate.
- Measure the difference in pressure between exchanger input and output and compare it with the graph on WATER SIDE EXCHANGER PRESSURE DROPS.

The measurement of pressure will be easier if pressure gauges are installed as indicated in the DIAGRAM OF SUGGESTED WATER CONNECTIONS .

REFRIGERANT CIRCUIT PARAMETER CHECK

Detecting the operational conditions is useful to control the unit along time: the performed records must be kept and be available during maintenance interventions.



When the unit works in stable conditions and according to the operating limits, take note of the following data:

1. compressor discharge temperature (WARNING – BURN DANGER)
2. condensing pressure
3. liquid temperature
4. dehydrator filter upstream and downstream temperature
5. return pressure
6. return temperature
7. exchanger input water temperature
8. exchanger output water temperature
9. return air temperature
10. supply air temperature
11. fresh air temperature (coil input)
12. air temperature coming out from fans

CONTROL

CONTROL INTERFACE

COOL cooling
HEAT heating

alarm ; OK 
inserted steps on total
ALARM menu access

HEAT / COOL
changement

off = unit OFF
on = unit ON

ON / OFF unit

unit status (ON – ECO –
OFF)

Enabled timing bands

INLET temperature

OUTLET temperature

Current set point

SET POINT, TIMING
BANDS, CLOCK access

Stata MENU access

Back to main menu

HELP parameter
descriptions

Back to previous shield

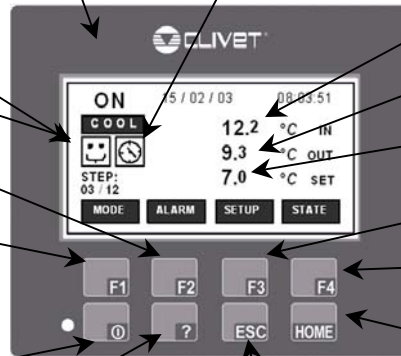

UNIT START-UP

To turn the unit on or off, hold the ON/OFF switch down for a few seconds. When the unit is on, the “ON” message is displayed; when the unit is off, the “OFF” message is displayed.

It is also possible to access the different menus when the unit is in the “OFF” mode.

It is possible to check the ON/OFF condition at a distance, using a remote device (see the ELECTRICAL CONNECTIONS chapter).

CHARACTERISTICS

THERMOREGULATION

The thermal regulation is based on the INLET temperature.

The unit is set for a specific TOTAL DIFFERENCE between the inlet and outlet water temperatures.

Usually the designed difference is 5°C, in the event that a different value is foreseen, the 17 and 18 parameters must be set again by the assistance center.

According to the total difference, the system defines the level of difference that each compressor can give : the STEP DIFFERENCE.

The regulations tend to gradually insert the compressors when the inlet temperature is over the set-point + the step difference.

The compressors are activated one per time at the end of the SCANNING TIME.

This time varies according to the gap between the water inlet temperature and the Set-point value. The higher the gap value is (both negative and positive), the shorter the interval among the scanning points will be.

The value of the scanning time is displayed at the status 6; when the status 7 has reached the value of the status 6, the request of operation of the compressor is activated.

The counting of the scanning time starts together with the activation of the compressor.

The compressor to be activated is chosen to make the shut circuits operate in order to minimize the wear of the entire refrigerating circuit, as well as the single compressor.

At the end of the counting, if the inlet temperature is higher than the step difference, another compressor is inserted.
temp. H2O > set-point + step difference.

What above described is referred to the COOLING operating, in HEATING the logics the same but overturned (compressor insertion for outlet temp. < set-point – step jump).

SET-POINT COMPENSATIONS

The compensations are evolved functions that aim at protecting the compressors and fit as much as possible, the operation of the unit to the characteristics of the system and its use.

The compensations make the time of the compressors’ operation longer and limit the number of starts-up, to make them delay the insertion time by adding an offset.

- The compensation on the DURATION is useful when the water contained in the system is limited.
- The compensation on the CHARGE is useful when a variable charge is present.

Optional components are necessary; the modifications of the parameters performed by the assistance centers have to be performed to enable and configure. In industrial applications, where a precise control of the temperature is necessary, it is possible to deactivate the COMPENSATIONS. The Status menu displays the value of the compensations on ext. temp. (status 9) and WR (status 10).

SET-POINT CORRECTIONS

The correction aim at optimising the energetic efficiency of the unit.

To do this, the corrections dynamically modify the set-point according to some variables. For example, in the summertime with very low external temperatures, therefore with a reduced load, it is possible to obtain the internal comfort even with set-points higher than the standard with a consequent higher energetic efficiency.

The *static* set-point can therefore be modified dynamically with two CORRECTIONS based on two factors external to the unit:

- Correction based on the External temp. / enthalpy
- Correction based on the Water reset (4-20 mA signal supplied by the Customer)

The *correct* set-point, to which all corrections have been added or detracted, is called PRESENT set-point and is visible at status 2.

For further details, see the ELECTRICAL CONNECTIONS chapter.

MAINTENANCE SET POINT

It can be used to maintain the installation inside the working limits, even if the unit is deactivated.

The MAINTENANCE Set Point checks the water temperature when the unit is put on OFF or Stand-by.

To do this, it periodically activates the circulation pump, tests the water temperature and even activates one or more compressors. It is necessary to modify the parameters with access reserved to the assistance centres

MENU	NUM	Parameter name	meaning
PARAMETER CONTROL MAINTENANCE	25	MantCoolEn	It enables Summer Maintenance
	114	SetMantCool	Summer maintenance set-point

DEMAND LIMIT

The function of the DEMAND LIMIT allows the limit of power so that the electric consumptions can be controlled by a signal external to the unit supplied by the customer.

On the STATUS menu, no. 22, the external signal of DEMAND LIMIT is displayed.

For further information, see the ELECTRICAL CONNECTIONS chapter.

SECOND SET-POINT

The secondary set point is activated by remote authorization (see the ELECTRICAL CONNECTIONS chapter).

It is possible to limit the minimum power which can be delivered during the time in which the secondary set point is activated by configuring the 276 MinPot2Set parameter (access reserved to the assistance centres).

TIME TABLES

The system is factory equipped with a clock function, found on the board.

By activating the timetables, it is possible to set up to 6 events for each day of the week.

If there is also a remote keyboard, the operations relative to the time and the date must be repeated on both keyboards, so that the two clocks (which are different) are synchronized.

ACCESSIBLE PARAMETERS

PARAMETER MENU STRUCTURE

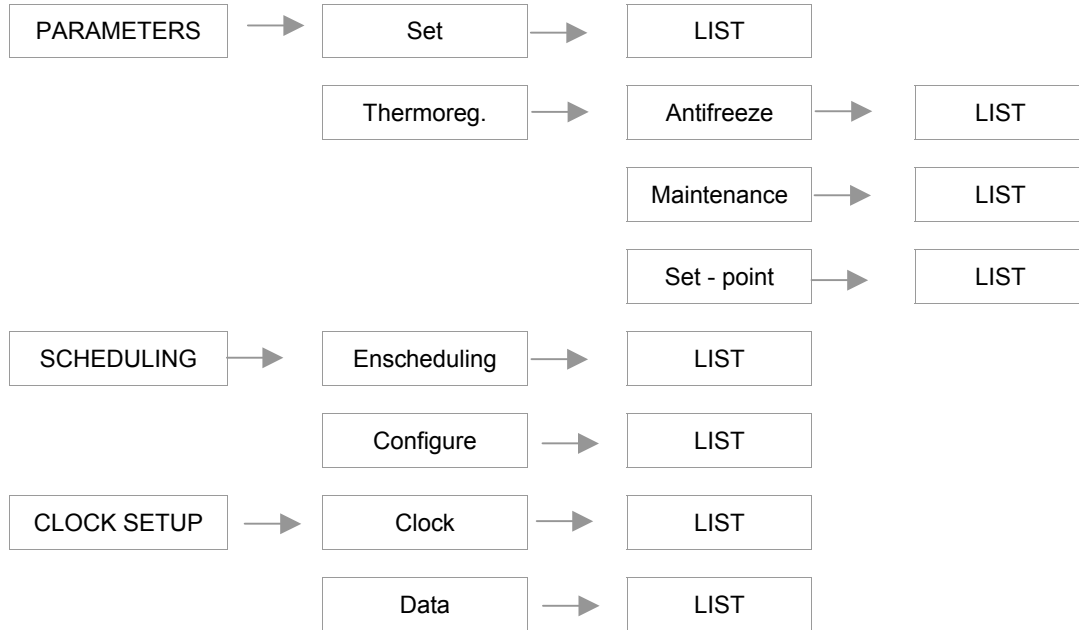

menu: PARAMETERS – THERMOREG. – SET POINT			DEFAULT values
90 / CEN	SecondSetC	Secondary cooling Set Point	12
118 / CEN	SetCool	Cooling Set Point	6.5
272 / CEN	SetRecovery	NOT USED	35
menu: PARAMETERS – THERMOREG. – MAINTENANCE			
114 / CEN	SetMantCool	Summer maintenance setpoint	15
menu: PARAMETERS - THERMOREG.– ANTIFREEZE			
115 / CEN	AllFreeze	Antifreeze alarm set	4
121 / CEN	PreAF	Antifreeze pre-alarm set	4.5
261 / CEN	SetResist	Antifreeze heater set	4
menu: PARAMETERS – SET – UNIT - EVAPORATORS			
37 / EVAP	SetResist	Antifreeze heater set	4
39 / EVAP	ALLFreeze	Antifreeze alarm set	4
41 / EVAP	PreAF	Antifreeze pre-alarm set	4.5

KEYPAD USE

SET UP menu:

PARAMETERS

set point modification

SCHEDULING

enables/disables timing bands

CLOCK SETUP







Set the clock

ID Tast-Cen

(ATC ONLY)

PASSWORD

(ATC ONLY)

To enter in the SETUP menu		button F3 SETUP
To select the submenu		buttons ▲ ▼ F2 – F3
To access		button F1 ENTER
To scrolling voices		buttons ▲ ▼ F2 - F3
To go back a level of the menu		button ESC
To go back to the main menu		button HOME







SETUP – PARAMETERS:

THERMOREG.

Set the setpoint and the operating modes

SET

(ATC ONLY)

To enter in the SETUP menu		button F3 SETUP
To select the submenu		buttons ▲ ▼ F2 – F3
To access		button F1 ENTER
To access the desired parameter		buttons ▲ ▼ F1 – F2
To modify the parameter value		buttons + - F3 – F4
To go back to the main menu		button HOME













SETUP – SCHEDULING:

EnSCHEDULING

enables/disables timing bands

CONFIGURE

Set the timing bands

To enter in the SETUP menu		button F3 SETUP
To select the CONFIGURE submenu		buttons ▲ ▼ F2 – F3
To access		button F1 ENTER
To select DAY		buttons ▲ ▼ F1 – F2
To change week day		button F3
To select one of the 6 available daily events		button F4
To select TIME		buttons ▲ ▼ F1 – F2
To set the event hour and minutes		buttons + + F3 – F4
To select STATE		buttons ▲ ▼ F1 – F2
Select ON/OFF/ECO mode		button F4
To select Setpoint		buttons ▲ ▼ F1 – F2
Set the manual setpoint of the event		buttons + - F3 – F4
To go back to the main menu		button HOME







SETUP – CLOCK SETUP

CLOCK

Set the clock

DATA

Set the dater

To enter in the SETUP menu		button F3 SETUP
To select the CLOCK SETUP submenu		buttons ▲ ▼ F2 – F3
To access to CLOCK		button F1 ENTER
To set HOURS MINUTES SECONDS		buttons F2 F3 F4
To confirm the single setting		button F1 ENTER
To go back to the main menu		button HOME

UNIT STATUS

A sub-menu is associated with each electronic module of the unit. It displays the system status. According to the unit configuration, and then with electronic modules and options, some sub-menus and statuses can not be used.

STATA STRUCTURE

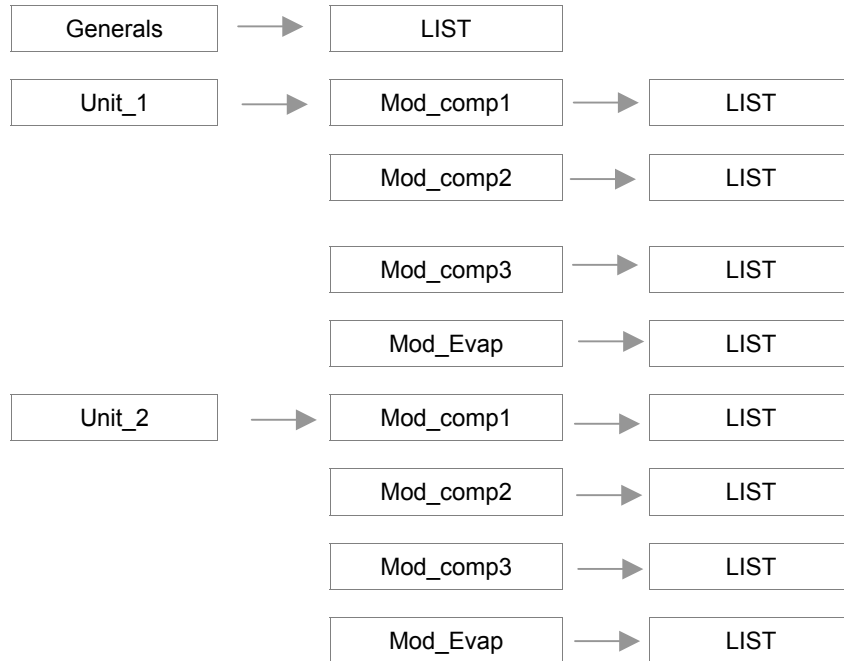

example

Visualized stata referring to
UNIT 1
COMP 2 MODULE

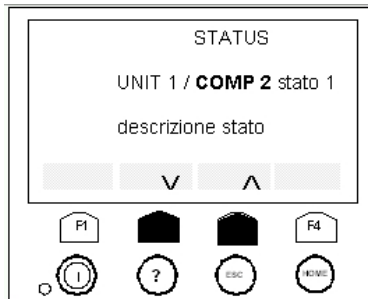

submenu:

GENERALS UNIT 1

mod_comp1
mod_comp2
mod_comp3
mod_evap

UNIT 2

mod_comp1
mod_comp2
mod_comp3
mod_evap

To enter in the STATA menu		button F4 STATE
To select the module		buttons ▲ ▼ F2 – F3
To access		button F1 ENTER
To scroll the stata		buttons ▲ ▼ F2 - F3
To go back a level of the menu		button ESC
To go back to the main menu		button HOME

Index	GENERAL stata	UM
0	Machine status	1=ON / 0=OFF
1	Machine mode	0=Cool, 1= Heat
2	Actual set point	°C (tenths)
3	Inlet temperature	°C (tenths)
4	Outlet temperature	°C (tenths)
5	Number of steps activated	
6	Current step value (compensations)	°C (tenths)
7	Step activation timer	sec
8	Step activation dynamic TimeScan	sec
9	CompExt	°C (tenths)
10	CompWR	°C (tenths)
11	CompCar	°C (tenths)
12	CompSpunti	°C (tenths)
13	CompDuty	°C (tenths)
14	Ambient temperature	°C (tenths)
15	Ambient humidity	%
16	Free Cooling valve percentage	%
17	Free Cooling flow percentage	%
18	Free Cooling valve control	1=ON / 0=OFF
19	Pump 1 status	1=ON / 0=OFF
20	Pump 2 status	1=ON / 0=OFF
21	Water Reset	%
22	Demand Limit	%
60	Digital input	bit map of a byte
68	Water flow analogic out	
69	Pump module digital out	bit map of a byte
71	BitMap connected nodes MS	bit map of a byte
72	Hours pump 1 PMP	
73	Hours pump 2 PMP	
74	Hours pump 3 PMP	

Index	UNIT_1 – MOD COMP_1 Stata	UM
29	Compressor 1	1=ON / 0=OFF
30	Compressor 2	1=ON / 0=OFF
31	Compressor 3	1=ON / 0=OFF
32	Cp 1 timer status	1=ON / 0=OFF
33	Cp 2 timer status	1=ON / 0=OFF
34	Cp 3 timer status	1=ON / 0=OFF
35	Valve 1 c1 status	1=ON / 0=OFF
36	Valve 2 c1 status	1=ON / 0=OFF
37	Valve 3 c1 status	1=ON / 0=OFF
38	Valve 1 c2 status	1=ON / 0=OFF
39	Valve 2 c2 status	1=ON / 0=OFF
40	Valve 3 c2 status	1=ON / 0=OFF
41	Valve 1 c3 status	1=ON / 0=OFF

Index	UNIT_1 – MOD COMP_1 Stata	UM
42	Valve 2 c3 status	1=ON / 0=OFF
43	Valve 3 c3 status	1=ON / 0=OFF
44	Liquid solenoid	1=ON / 0=OFF
45	Coil temperature	°C (tenths)
46	Recovery temperature	°C (tenths)
47	Condensation pressure	bar
48	Evaporation pressure	bar
49	Fan Status	bar
50	Defrost Status	1=ON / 0=OFF
51	Defrost count time	sec
52	Compressor 1 operating time	
53	Comp. 1 starts	
54	Compressor 2 operating time	
55	Comp. 2 starts	

Index	UNIT_1 – MOD COMP_1 Stata	UM
56	Compressor 3 operating time	
57	Comp. 3 starts	
58	Recovery valve	1=ON / 0=OFF
59	Recovery PREHP delay	sec
61	Digital input	bit map of a byte
75	Daikin calculated power	%
76	PEvapOp	bar
77	Taspirazione	°C(tenths)
78	Tscarico	°C(tenths)
79	Valve opening	%
80	SuperHeat	°C(tenths)
81	SuperHeatSPOperativo	°C(tenths)
82	TempSaturaCondensazione	°C(tenths)

Index	UNIT_1 – MODEVAP_1 Stata	UM
23	Tout1	°C (tenths)
24	Tout2	°C (tenths)
25	Tinput	°C (tenths)
26	Pump 1 status	1=ON / 0=OFF
27	Pump 2 status	1=ON / 0=OFF
28	Heater status	1=ON / 0=OFF
62	Digital input	bit map of a byte

ALARMS

BEFORE RESETTING THE ALARM, IDENTIFY AND ELIMINATE THE CAUSE OF ITS ACTIVATION.
REPEATED RESETS CAN CAUSE IRREVERSIBLE DAMAGES.



The presence of an alarm is signaled by the icon flashing.

The cumulative block relay activates simultaneously, according to the type of alarm.

Alarms can be reset once the conditions that caused them to trip have been removed.

ALARMS and faults show a potentially dangerous situation for the machine integrity. An immediate analysis is necessary to detect the causes of the block. A repeated reset can provoke irreversible damage. That is why reset is MANUAL.

PRE-ALARMS AND SIGNALIZATIONS show a situation similar to that one described above. The occurrence of an alarm is acceptable if it is occasional and/or in transitory situations (for example, when the plant starts). In uncertain cases, please contact the authorized assistance center.

VIEW ALARM



To visualize the alarm in progress

STORE ALARM

To visualize the historical alarm

DEL STORE

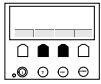
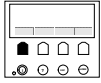
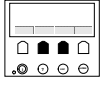
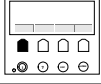
To delete the historical alarm

To enter in the ALARM menu		button F2 ALARM
To select VIEW ALARM		buttons ▲ ▼ F2 – F3
To access		button F1 ENTER
To scroll the active alarms		buttons ▲ ▼ F2 - F3
To reset the alarm in progress		button F1 ENTER
To go back a level of the menu		button ESC
To go back to the main menu		button HOME

An alarm list is associated with the inputs of each electronic module of the unit.

According to the unit configuration, and then with electronic modules and options, some lists and/or ALARMS can not be used.

ALARM STRUCTURE

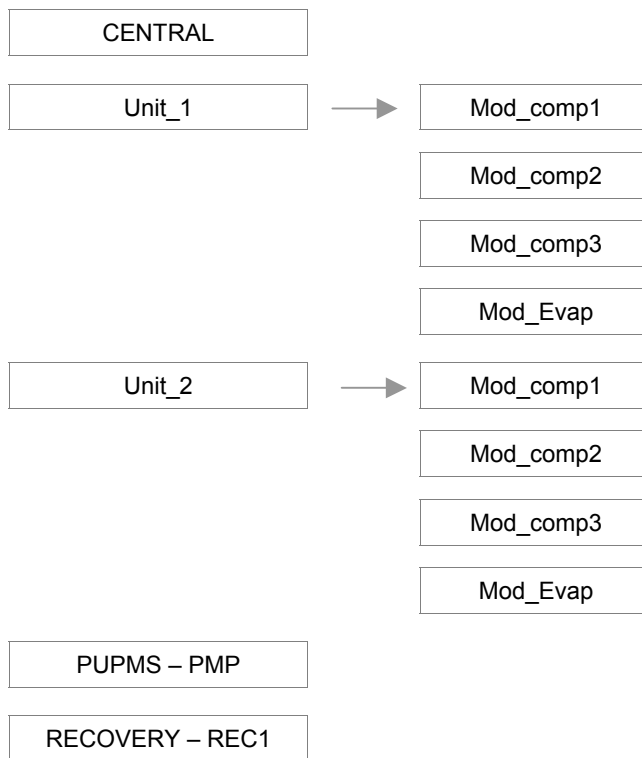

example

CEN : central module alarm
 14 : alarm identificative string
 E014 : alarm description

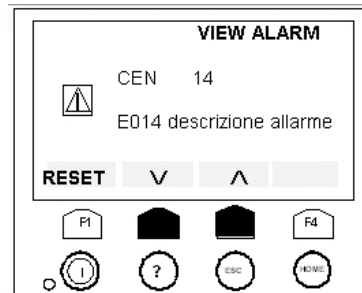

CENTRAL MODULE

Str	Name
0	E001 H2O IN temp. probe fault on control module
1	E002 H2O OUT temp. probe fault on control module
2	E003 Outside air temp. probe fault
3	E004 Water Reset input fault
4	E005 Outside RH% probe fault
5	E006 Thermal cut-out alarm pump 1 on control module
6	E007 Thermal cut-out alarm pump 2 on control module
7	E008 Flow switch alarm on control module
8	E009 System pressure alarm
9	E010 Phase monitor alarm
10	E011 Antifreeze alarm on control module
11	E012 Antifreeze pre-alarm on control module
12	E013 Change CENTRAL pump
13	E014 Unit configuration alarm
14	E015 Demand Limit input fault
15	E016 Can net disconnectedness on control module
59	E017 Inhibits control in heating
60	E018 Incongruent deltaT alarm
62	E019 Ext low temperature alarm

COMPRESSOR MODULE		
Str	Name	
16	E101	Cond./ Evap. temp. probe fault
17	E102	Condensing pressure probe fault
18	E103	Evaporation pressure probe fault
19	E104	Recovery temp. probe fault
20	E105	High pressure alarm
21	E106	Low pressure alarm
22	E107	Fan/Pump thermal cut-out alarm
23	E111	Cond. / Evap. H2O flow alarm
24	E112	High pressure pre-alarm 1
25	E113	High pressure pre-alarm 2
26	E114	Low pressure pre-alarm
27	E115	Force defrost alarm
28	E116	Max Press. diff. alarm
29	E117	Recovery H2O flow alarm
30	E118	Heat recovery HP pre-alarm
31	E108	Compressor 1 thermal cut-out alarm
32	E109	Compressor 2 thermal cut-out alarm
33	E110	Compressor 3 thermal cut-out alarm
47	E213	Module not connected
49	E119	Oil differential pressure alarm
58	E120	Condenser frost alarm
61	E121	BP2 prealarm
63	E123	TA TEE alarm
64	E124	TS TEE alarm
65	E125	max TS TEE prealarm
66	E126	max TS TEE prealarm
67	E127	power fail alarm
68	E128	stepper motor error alarm

PUMP MODULE		
Str	Name	
53	E501	Water flow probe fault
54	E502	Thermal pump 1alarm Pump Module
55	E503	Thermal pump 2alarm Pump Module
56	E504	Thermal pump 3alarm Pump Module
57	E505	Max flow-rate signal Pump Module

RECOVERY EXPANSION MODULE		
Str	Name	
50	E301	Out recovery probe alarm
51	E302	Gas temperature probe alarm

EVAPORATOR MODULE		
Str	Name	
34	E201	Evaporator inlet probe fault
35	E202	Evaporator outlet probe 1 fault
36	E202	Evaporator outlet probe 2 probe fault
37	E203	Programmable evaporator input alarm
38	E204	Thermal cut-out alarm, evaporator pump 1
39	E205	Thermal cut-out alarm, evaporator pump 2
40	E206	Evaporator flow switch alarm
41	E207	Evaporator system fill alarm
42	E208	Change pumps on evaporator
43	E209	Antifreeze alarm on evaporator
44	E210	Tout 1, antifreeze pre-alarm on evaporator
45	E211	Tout 2, antifreeze pre-alarm on evaporator
46	E212	System pump lockout
48	E214	Module not connected

ROUTINE MAINTENANCE

BEFORE UNDERTAKING ANY SORT OF MAINTENANCE OR CLEANING, DISCONNECT THE ELECTRICAL POWER SUPPLY TO THE UNIT, AND ENSURE THAT OTHER PEOPLE CANNOT RE-CONNECT IT .

All equipment is subjected to wear out.

The maintenance makes :

1. keeps the unit efficiency
2. the components last longer
3. keeps their efficiency and limits breakdowns

Therefore, it is fundamental to perform periodical checks:

a few controls can be performed by the user (AUTONOMOUS MAINTENANCE) and they are mainly cleaning activities; otherwise, controls have to be performed by specialized technicians (INSPECTIONS).

The machine should have a log book used to keep track of the performed controls. This will make fixing up breakdowns easier.

Take note of the date, type of control (autonomous maintenance, inspection or fixing up), description of the control, actions taken and so on.

SERVICES : parts subject to intervention

- **STRUCTURE**
- **EXTERNAL FANS**
- **FRESH AIR COIL**
- **WATER EXCHANGER**

STRUCTURE

Check the condition of the parts making up the structure. Paint so as to eliminate or reduce oxidation at the points in the unit where this problem may occur. Check that the panelling is fastened correctly. Poor fastening may give rise to malfunctions and abnormal noise and vibration.

FRESH AIR COIL

ATTENTION: contact with the exchanger fins can cause cuts. Wear protective gloves to perform the above described operations.

It is extremely important that the battery gives the maximum thermal exchange; therefore, its surface must be cleaned from dust and deposits. Remove all impurities from the surface.

Using an air pressure gun, clean the aluminum surface of the battery. Be careful to direct the air in the opposite direction of the fan air movement. Hold the gun parallel to the fins to avoid damages. As an alternative, an aspirator can be used to suck impurities from the air input side.

Verify that the aluminum fins are not bent or damaged. In the event of damages, contact the authorized assistance center and get the battery "ironed out" in order to restore the initial condition for an optimal air flow.

ELECTRIC FANS

Make sure that the fans and the relative protection grids are well fixed.

Check, if possible, the unbalances of the electro-fan evident by noise and anomalous vibrations. Verify that the terminal protection covers are closed and the cable holders are properly positioned.

WATER EXCHANGER

It is very important for the exchanger to be able to provide the maximum thermal exchange. Therefore, it is essential for the inner surfaces to be clean of dirt and incrustations.

Periodically check the difference between the temperature of the supply water and the condensation temperature. If the difference is greater than 8°C–10°C it is advisable to clean the exchanger.

MAINTENANCE INSPECTIONS

Foresee inspection assistance carried out by authorized centers or by qualified personnel.

The inspections should be carried out at least:

- - Every year for only the cooling units
- - Every six months for the cooling and warming units

The frequency, however, depends on the use: in the event of frequent use (continuous or very intermittent use, near the operating limits, etc) or critical use (service necessary) it is recommended to plan inspections at close intervals.

For units equipped with safety valves, follow the Manufacturer's instructions.

Verify periodically the cleaning of the safety valves and that oxidative / corrosive phenomena are not present, in particular for installations near the sea, in industrial areas or in rooms with a corrosive atmosphere.

The inspections to be performed are as follows:

- verify the power supply tension (when emptied or filled)
- inspect the electrical board (status of solenoid starter contacts, terminal closings, the status of wiring and relevant insulations)
- inspect the absorption of the single electrical loads
- verify the cleaning and the efficiency of the exchangers
- inspect the cleaning of the filters (air/water)
- verify the leakage from the refrigerating circuit
- Verify the protection devices (safety valves, pressure switches, thermostats, etc.), the adjustment systems, the control devices (alarm signalizations, probes, manometers, etc)
- check the operating parameters of the refrigerating circuit (see the following REFRIGERANT TABLES and the START-UP section)

97/23 CE PED DIRECTIVE

97/23 CE PED DIRECTIVE gives instructions for installers, users and maintenance technicians as well. Refer to local actuation norms.

In Italy, refer to the Ministerial Decree of 1st December 2004 no. 329 (and following modifications) which defines the performances to be executed; the units of 1st category and those defined by the art. 3.3 97/23/EC are not included in this regulation (see the serial number plate on the unit) .

Briefly and as an example, see the following :

1. COMPULSORY VERIFICATION OF THE FIRST INSTALLATION only for units assembled on the installer's building site (for ex. Condensing circuit + direct expansion unit)
2. CERTIFICATION OF SETTING IN SERVICE for all the units
3. PERIODICAL VERIFICATIONS to be executed with the frequency indicated by the Manufacturer (see the MAINTENANCE INSPECTIONS paragraph)

PUT AT REST

If a long period of inactivity is foreseen, for example the winter for the cooling unit, the following is recommended:

- to turn the power off in order to avoid electrical risks or damages by lightning strike
- to avoid the risk of frosts as shown in the HYDRAULIC CONNECTIONS section, and, in particular
 - to empty or add glycole in the plant sections subjected to temperatures below zero
 - to empty or add glycole in the water heating coils, also in summer
 - to power antifreeze resistances if present

If the period of inactivity is particularly long or in the event of extremely low temperatures, the external fans can be blocked temporarily; therefore, it is recommended to switch them on every month in order to avoid seizures or electrical overloads when the unit will be switched on.

The restarting of the unit has to be carried out by qualified personnel, in particular, after the winter break for cooling units or when seasonal switching should be performed.

When restarting, refer to the SWITCHING ON section.

Schedule technical assistance in advance to avoid hitches and be able to use the installation when necessary.

REFRIGERANT TABLES

THIS SECTION IS DEVOTED ONLY TO QUALIFIED TECHNICIANS THAT KNOW THE FOLLOWING:

- THE OPERATIONAL PRINCIPLES OF THE REFRIGERATING CIRCUIT OPERATION
- THE MODES OF DETECTING TEMPERATURE AND PRESSURE
- THE RISKS RELEVANT TO THESE OPERATIONS

The data of the tables allow the testing of the refrigerating circuit operation by the detection of a few objective parameters. The data are significant if they are detected simultaneously and while the refrigerating circuit is running.

OVERHEATING = return temperature – Saturation temperature		SUBCOOLING = condensing temperature (pressure *) – liquid temperature	
Return pressure	3.0 bar	Condensing pressure	16.0 bar
Return temperature	11.0 °C	Liquid temp.	50 °C
overheating	11 – 8.93 = 2°	subcooling	60.46 – 50 = 10.46°

* It is important that the condensation pressure is detected as close as possible to the point where the liquid temperature is detected, in the event that the calculation will be effected by the losses of charge (and, therefore, of temperature) caused by the refrigerating circuit components placed between the two measurement points.

Pg = P gauge = relevant pressure (read on the pressure gauge) , Ts = saturation pressure

R 134A															
Pg	Ts [°C]	Pg	Ts [°C]	Pg	Ts [°C]	Pg	Ts [°C]	Pg	Ts [°C]	Pg	Ts [°C]	Pg	Ts [°C]	Pg	Ts [°C]
0.0	-26.36	5.0	21.57	10.0	42.97	15.0	57.91	20.0	69.64	25.0	79.41	30.0	87.79	35.0	95.12
0.2	-22.31	5.2	22.65	10.2	43.66	15.2	58.43	20.2	70.07	25.2	79.76	30.2	88.10	35.2	95.40
0.4	-18.76	5.4	23.70	10.4	44.33	15.4	58.94	20.4	70.49	25.4	80.12	30.4	88.41	35.4	95.67
0.6	-15.59	5.6	24.73	10.6	45.00	15.6	59.45	20.6	70.90	25.6	80.48	30.6	88.72	35.6	95.94
0.8	-12.71	5.8	25.73	10.8	45.66	15.8	59.96	20.8	71.32	25.8	80.83	30.8	89.03	35.8	96.21
1.0	-10.08	6.0	26.71	11.0	46.32	16.0	60.46	21.0	71.73	26.0	81.18	31.0	89.33	36.0	96.48
1.2	-7.64	6.2	27.67	11.2	46.96	16.2	60.95	21.2	72.14	26.2	81.53	31.2	89.64	36.2	96.75
1.4	-5.37	6.4	28.62	11.4	47.59	16.4	61.44	21.4	72.54	26.4	81.87	31.4	89.94	36.4	97.01
1.6	-3.24	6.6	29.54	11.6	48.22	16.6	61.93	21.6	72.95	26.6	82.22	31.6	90.24	36.6	97.28
1.8	-1.23	6.8	30.44	11.8	48.84	16.8	62.42	21.8	73.35	26.8	82.56	31.8	90.54	36.8	97.54
2.0	0.67	7.0	31.33	12.0	49.46	17.0	62.90	22.0	73.74	27.0	82.90	32.0	90.83	37.0	97.80
2.2	2.48	7.2	32.20	12.2	50.06	17.2	63.37	22.2	74.14	27.2	83.24	32.2	91.13	37.2	98.06
2.4	4.20	7.4	33.05	12.4	50.66	17.4	63.84	22.4	74.53	27.4	83.58	32.4	91.43	37.4	98.32
2.6	5.84	7.6	33.89	12.6	51.26	17.6	64.31	22.6	74.92	27.6	83.91	32.6	91.72	37.6	98.58
2.8	7.42	7.8	34.72	12.8	51.84	17.8	64.77	22.8	75.31	27.8	84.24	32.8	92.01	37.8	98.84
3.0	8.93	8.0	35.53	13.0	52.42	18.0	65.23	23.0	75.69	28.0	84.58	33.0	92.30	38.0	99.09
3.2	10.39	8.2	36.32	13.2	53.00	18.2	65.69	23.2	76.07	28.2	84.90	33.2	92.59	38.2	99.34
3.4	11.79	8.4	37.11	13.4	53.56	18.4	66.14	23.4	76.45	28.4	85.23	33.4	92.88	38.4	99.60
3.6	13.15	8.6	37.88	13.6	54.13	18.6	66.59	23.6	76.83	28.6	85.56	33.6	93.16	38.6	99.85
3.8	14.46	8.8	38.64	13.8	54.68	18.8	67.04	23.8	77.21	28.8	85.88	33.8	93.45	38.8	100.09
4.0	15.74	9.0	39.39	14.0	55.23	19.0	67.48	24.0	77.58	29.0	86.20	34.0	93.73	39.0	100.34
4.2	16.97	9.2	40.13	14.2	55.78	19.2	67.92	24.2	77.95	29.2	86.52	34.2	94.01	39.2	100.59
4.4	18.17	9.4	40.85	14.4	56.32	19.4	68.36	24.4	78.32	29.4	86.84	34.4	94.29	39.4	100.83
4.6	19.33	9.6	41.57	14.6	56.85	19.6	68.79	24.6	78.68	29.6	87.16	34.6	94.57		
4.8	20.47	9.8	42.27	14.8	57.38	19.8	69.22	24.8	79.04	29.8	87.47	34.8	94.85		

TROUBLESHOOTING

THE OPERATIONS MUST BE CARRIED OUT BY TECHNICAL QUALIFIED PERSONNEL HAVING THE REQUISITES UNDER LAW REQUISITES AND IN CONFORMITY WITH THE SAFETY REGULATIONS IN FORCE.

THE INTERVENTIONS WITHIN THE WARRANTY PERIOD WILL BE CARRIED OUT BY AUTHORIZED SERVICE CENTERS.

**BEFORE RESETTING AN ALARM, IDENTIFY AND ELIMINATE ITS CAUSE.
REPEATED RESETS MAY CAUSE SERIOUS DAMAGES.**

In certain machine configurations, some safeties may be placed in series and lead back to a single input on the electronic module.

Therefore, check on the electrical diagram whether the device to which the alarm corresponds has other devices or safeties connected in series.

Below is a list of the possible causes of alarms.

HIGH PRESSURE

1. high water temperature (see operating limits)
2. high air temperature (see operating limits)
3. coil dirty / clogged
4. fans don't work / low speed
5. Manostat/transducer: loose electric contacts/terminals, wiring cables interrupted
6. Anti-condensation gas in the cooling circuit
7. Too much refrigerant
8. Check the trigger point for the manostat and transducer
9. Check the manostat or transducer pressure control point (deposits of oil, dirt, pin blocked mechanically)

LOW PRESSURE

1. low air temperature (see operating limits)
2. low water temperature (see operating limits)
3. insufficient water flow to the exchanger (high thermal difference between input and output)
4. not CONSTANT flow (for example, if the pumps are turned off, certain areas of the plant are excluded or included, other uses are isolated, etc)
5. Water filter clean / valves open /air bubbles in the plant
6. dirty exchanger
7. Manostat/transducer: loose electric contacts/terminals, wiring cables interrupted
8. refrigerant circuit empty, visible leaks of refrigerant/oil, insufficient charge
9. Blocked dehydrator filter
10. thermostatic device not operating correctly
11. Check the trigger point for the manostat and transducer
12. Check the manostat or transducer pressure control point (deposits of oil, dirt, pin blocked mechanically)

FAULTY PROBE

1. Identify the part on the wiring diagram.
2. Loose electric contacts/terminals, leads broken
3. Check the correct probe ohmic level (using a tester)
4. Change the probe.
5. Check the electronic module configuration (only an authorised service centre can do this)
6. Change the electronic module

FAULTY PRESSURE TRANSDUCER

1. Identify the part on the wiring diagram
2. Loose electric contacts/terminals, leads broken
3. Check the pressure test points are in working order
4. Change the part
5. Check the electronic module configuration (only an authorised service centre can do this)
6. Change the electronic module

COMPRESSOR PROTECTION

1. Identify the part on the wiring diagram
2. Loose electric contacts/terminals, leads broken
3. electrical windings interrupted
4. Vacuum power voltage below the limits
5. power contactors / contacts defective
6. start-up power voltage lower than the limits
7. electrical absorption high / unbalanced
8. High compressor discharge temperature > thermostatic device needs calibrating, insufficient refrigerant charge

FAN PROTECTION

1. Identify the part on the wiring diagram
2. fan mechanically jammed, bearings / drive belt (if present)
3. Loose electric contacts/terminals, leads broken
4. electrical windings of fan interrupted
5. power supply voltage below limits
6. electrical absorption high / unbalanced

PUMP PROTECTION

1. Identify the part on the wiring diagram
2. pump jammed (probable for circulator pump after lengthy seasonal shutdowns)
3. Loose electric contacts/terminals, leads broken
4. electrical windings of fan interrupted
5. power supply voltage below limits
6. electrical absorption high / unbalanced

DECOMMISSIONING OF THE UNIT

DISCONNECTING THE UNIT

The units must be disconnected by authorised personnel, who before proceeding must first read the Residual Risks section in this manual.

Before disconnecting the unit, the following must be recovered, if present:

- the refrigerant (if the circuits cannot be isolated): the refrigerant must be removed using suction devices operating in a closed circuit, so as to ensure that none of the compound is released into the atmosphere.
- the antifreeze in the circuits: when removing this fluid, make sure that it does not leak and that it is not released into the environment. The antifreeze fluid must be stored in special containers.

When recovering the substances present in the unit, all measures must be taken to avoid damaging persons and things and polluting the surrounding area.

Awaiting dismantling and disposal, the unit can also be stored outdoors, as bad weather and rapid changes in temperature will not cause damage to the environment, if electric, cooling and hydraulic circuits of the unit are integral and closed.

DISMANTLING AND DISPOSAL

THE UNIT MUST ALWAYS BE SENT TO AUTHORISED CENTRES FOR DISMANTLING AND DISPOSAL.

When dismantling the unit, the fan, the motor and the coil, if operating, may be recovered by the specialist centres for reuse.

All the materials must be recovered or disposed of in compliance with the corresponding national standards in force.

For further information on the decommissioning of the unit, contact the manufacturer.

TECHNICAL DATA

DIMENSIONS

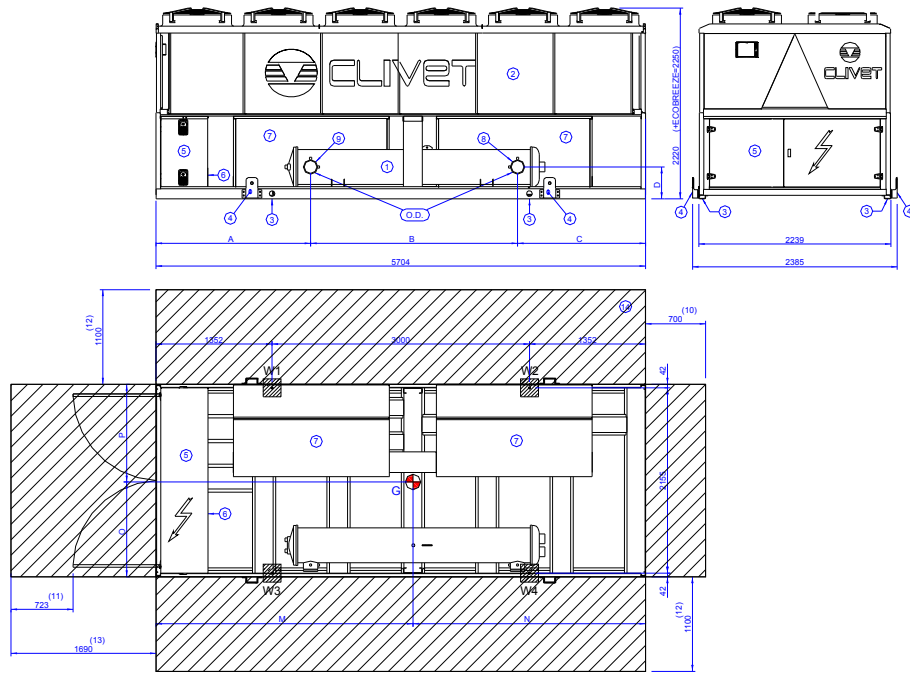

- (1) INTERNAL EXCHANGER (EVAPORATOR)
- (2) EXTERNAL EXCHANGER (CONDENSER)
- (3) HOLE TO HANG UNIT
- (4) LIFTING BRACKETS (REMOVABLE, IF REQUIRED, AFTER POSITIONING THE UNIT)
- (5) ELECTRICAL PANEL
- (6) POWER INPUT
- (7) SOUND PROOF ENCLOSURE (ONLY IN THE EXPECTED VERSIONS)
- (8) INTERNAL EXCHANGER WATER INLET
- (9) INTERNAL EXCHANGER WATER OUTLET
- (10) MINIMUM DIMENSION FOR A SAFE PASSAGE.
- (11) MINIMUM DIMENSION FOR A SAFE PASSAGE WHEN THE DOOR OF THE ELECTRICAL SWITCHBOARD IS OPEN.
- (12) MINIMUM DIMENSION FOR A PROPER AIR FLOW TO THE CONDENSER COIL. IN THE CASE OF TWO UNITS SIDE BY SIDE THIS DISTANCE MUST BE DOUBLED
- (13) MINIMUM DIMENSION ON THE ELECTRICAL SWITCHBOARD SIDE.
- (14) CLEARANCE ACCESS RECOMMENDED
- (G) BARYCENTRE

SIZE		ST				SC				LN	
		2.160	2.180	2.190	2.200	2.160	2.180	2.190	2.200	2.160	2.180
A	mm	2147	2147	2147	1800	2147	2147	2147	1800	2147	2147
B	mm	2450	2450	2450	2412	2450	2450	2450	2412	2450	2450
C	mm	1107	1107	1107	1492	1107	1107	1107	1492	1107	1107
D	mm	331	331	331	371	331	331	331	371	331	331
M	mm	2738	2739	2724	2763	2753	2754	2739	2772	2753	2756
N	mm	2966	2965	2980	2941	2951	2950	2965	2932	2951	2948
O	mm	1298	1300	1300	1267	1322	1324	1323	1290	1322	1319
P	mm	941	939	939	972	917	915	916	949	917	920
OD	mm	141.3	141.3	141.3	168.3	141.3	141.3	141.3	168.3	141.3	141.3
Length	mm	5704	5704	5704	5704	5704	5704	5704	5704	5704	5704
Depth	mm	2239	2239	2239	2239	2239	2239	2239	2239	2239	2239
Height	mm	2220	2220	2220	2220	2220	2220	2220	2220	2220	2220
W1	kg	1278	1284	1360	1419	1363	1370	1446	1504	1363	1399
W2	kg	1191	1198	1258	1342	1285	1291	1351	1435	1285	1320
W3	kg	1090	1094	1159	1242	1137	1140	1206	1289	1137	1169
W4	kg	1003	1007	1057	1166	1058	1062	1111	1220	1058	1091
Operating weight	kg	4563	4584	4834	5169	4843	4864	5114	5449	4843	4980
Shipping weight	kg	4399	4425	4682	4906	4679	4705	4962	5186	4679	4821

Particular accessories, executions or versions can bring about a great variation of the mass represented here. Please contact our Technical Department.

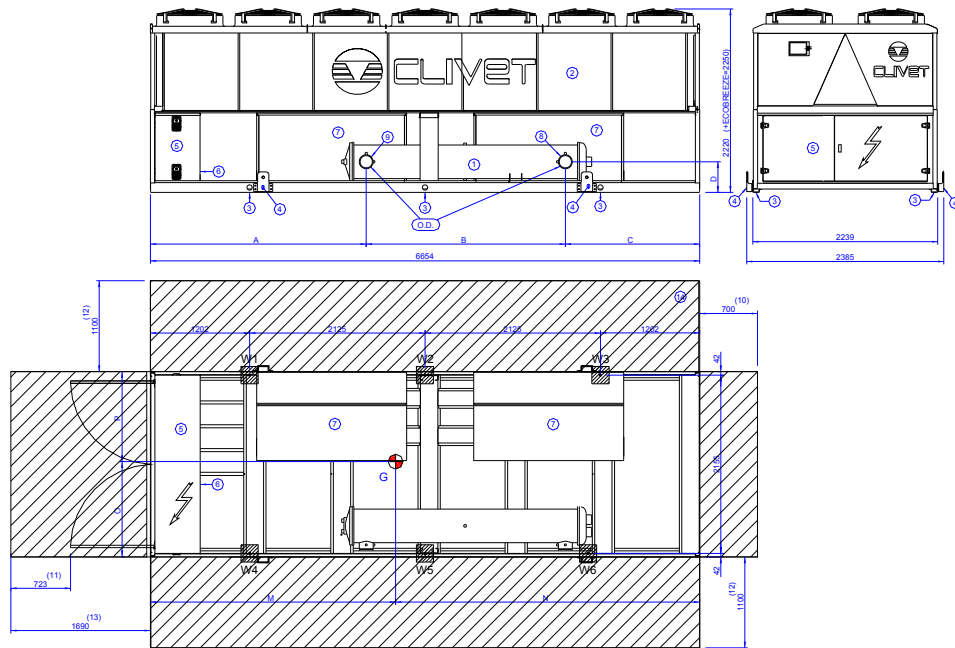

- (1) INTERNAL EXCHANGER (EVAPORATOR)
- (2) EXTERNAL EXCHANGER (CONDENSER)
- (3) HOLE TO HANG UNIT
- (4) LIFTING BRACKETS (REMOVABLE, IF REQUIRED, AFTER POSITIONING THE UNIT)
- (5) ELECTRICAL PANEL
- (6) POWER INPUT
- (7) SOUND PROOF ENCLOSURE (ONLY IN THE EXPECTED VERSIONS)
- (8) INTERNAL EXCHANGER WATER INLET
- (9) INTERNAL EXCHANGER WATER OUTLET
- (10) MINIMUM DIMENSION FOR A SAFE PASSAGE.
- (11) MINIMUM DIMENSION FOR A SAFE PASSAGE WHEN THE DOOR OF THE ELECTRICAL SWITCHBOARD IS OPEN.
- (12) MINIMUM DIMENSION FOR A PROPER AIR FLOW TO THE CONDENSER COIL.
IN THE CASE OF TWO UNITS SIDE BY SIDE THIS DISTANCE MUST BE DOUBLED
- (13) MINIMUM DIMENSION ON THE ELECTRICAL SWITCHBOARD SIDE.
- (14) CLEARANCE ACCESS RECOMMENDED
- (G) BARYCENTRE

SIZE		ST		SC		LN			
		2.240	2.280	2.240	2.280	2.190	2.200	2.240	2.280
A	mm	2615	2615	2615	2615	2600	2615	2615	2615
B	mm	2412	2412	2412	2412	2450	2412	2412	2412
C	mm	1627	1627	1627	1627	1604	1627	1627	1627
D	mm	371	371	371	371	331	371	371	371
M	mm	3274	3275	3291	3292	3238	3291	3293	3293
N	mm	3380	3379	3363	3362	3416	3363	3361	3361
O	mm	1207	1209	1243	1245	1266	1238	1238	1240
P	mm	1032	1030	996	994	973	1001	1001	999
OD	mm	168.3	168.3	168.3	168.3	141.3	168.3	168.3	168.3
Length	mm	6654	6654	6654	6654	6654	6654	6654	6654
Depth	mm	2239	2239	2239	2239	2239	2239	2239	2239
Height	mm	2220	2220	2220	2220	2220	2220	2220	2220
W1	kg	817	820	877	880	920	897	917	921
W2	kg	1204	1214	1353	1362	1241	1368	1390	1400
W3	kg	748	752	825	830	797	845	866	870
W4	kg	699	699	703	703	708	725	742	742
W5	kg	1030	1034	1085	1088	954	1106	1125	1128
W6	kg	640	641	661	663	613	683	701	702
Operating weight	kg	5138	5160	5504	5526	5233	5625	5741	5763
Shipping weight	kg	4883	4912	5249	5278	5080	5362	5486	5515

Particular accessories, executions or versions can bring about a great variation of the mass represented here. Please contact our Technical Department.

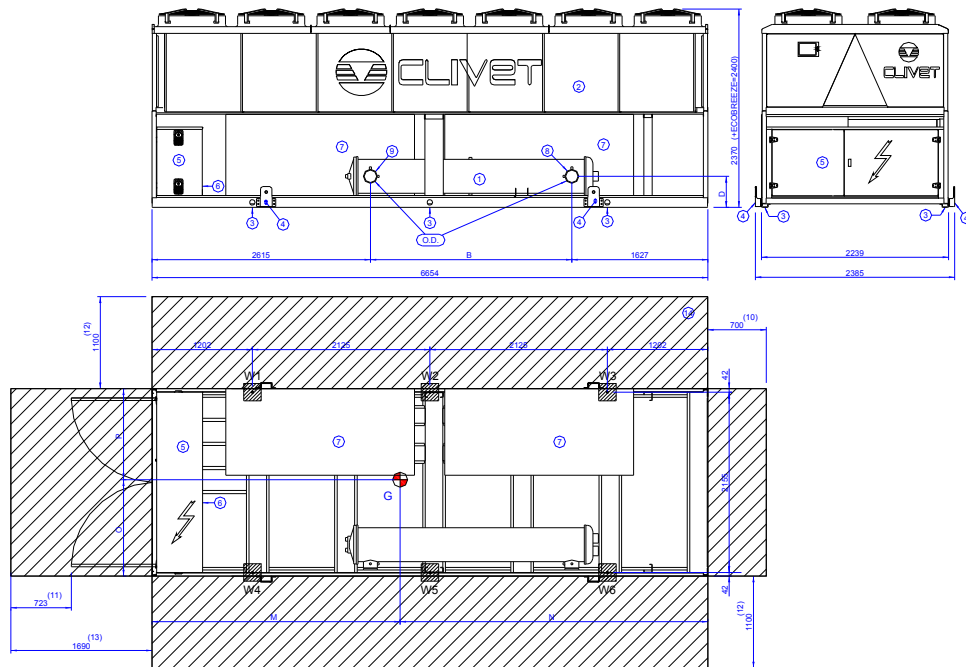

- (1) INTERNAL EXCHANGER (EVAPORATOR)
- (2) EXTERNAL EXCHANGER (CONDENSER)
- (3) HOLE TO HANG UNIT
- (4) LIFTING BRACKETS (REMOVABLE, IF REQUIRED, AFTER POSITIONING THE UNIT)
- (5) ELECTRICAL PANEL
- (6) POWER INPUT
- (7) SOUND PROOF ENCLOSURE (ONLY IN THE EXPECTED VERSIONS)
- (8) INTERNAL EXCHANGER WATER INLET
- (9) INTERNAL EXCHANGER WATER OUTLET
- (10) MINIMUM DIMENSION FOR A SAFE PASSAGE.
- (11) MINIMUM DIMENSION FOR A SAFE PASSAGE WHEN THE DOOR OF THE ELECTRICAL SWITCHBOARD IS OPEN.
- (12) MINIMUM DIMENSION FOR A PROPER AIR FLOW TO THE CONDENSER COIL.
IN THE CASE OF TWO UNITS SIDE BY SIDE THIS DISTANCE MUST BE DOUBLED
- (13) MINIMUM DIMENSION ON THE ELECTRICAL SWITCHBOARD SIDE.
- (14) CLEARANCE ACCESS RECOMMENDED
- (G) BARYCENTRE

SIZE	ST		SC		
	2.300	2.320	2.300	2.320	
A	mm	2615	2615	2615	2615
B	mm	2412	2412	2412	2412
C	mm	1627	1627	1627	1627
D	mm	371	371	371	371
M	mm	3114	3161	3126	3165
N	mm	3540	3493	3528	3489
O	mm	1202	1202	1237	1204
P	mm	1037	1037	1002	1035
OD	mm	168.3	168.3	168.3	168.3
Length	mm	6654	6654	6654	6654
Depth	mm	2239	2239	2239	2239
Height	mm	2370	2370	2370	2370
W1	kg	1079	1086	1151	1127
W2	kg	1103	1245	1248	1347
W3	kg	782	837	845	872
W4	kg	930	937	932	968
W5	kg	952	1074	1010	1158
W6	kg	674	723	684	750
Operating weight	kg	5520	5902	5870	6222
Shipping weight	kg	5279	5661	5629	5981

Particular accessories, executions or versions can bring about a great variation of the mass represented here. Please contact our Technical Department.

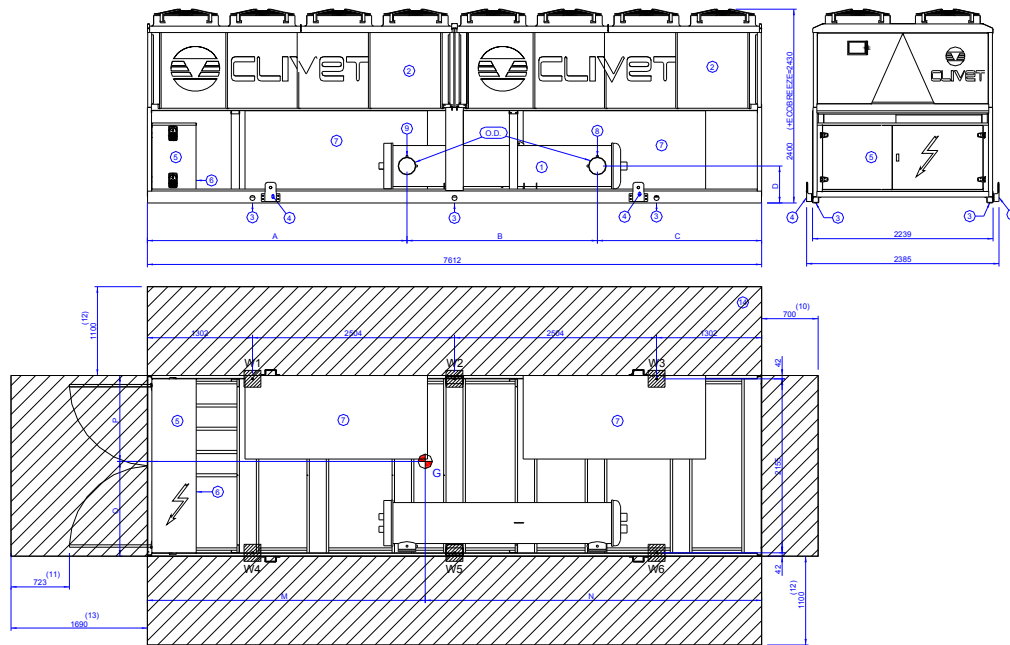

- (1) INTERNAL EXCHANGER (EVAPORATOR)
- (2) EXTERNAL EXCHANGER (CONDENSER)
- (3) HOLE TO HANG UNIT
- (4) LIFTING BRACKETS (REMOVABLE, IF REQUIRED, AFTER POSITIONING THE UNIT)
- (5) ELECTRICAL PANEL
- (6) POWER INPUT
- (7) SOUND PROOF ENCLOSURE (ONLY IN THE EXPECTED VERSIONS)
- (8) INTERNAL EXCHANGER WATER INLET
- (9) INTERNAL EXCHANGER WATER OUTLET
- (10) MINIMUM DIMENSION FOR A SAFE PASSAGE.
- (11) MINIMUM DIMENSION FOR A SAFE PASSAGE WHEN THE DOOR OF THE ELECTRICAL SWITCHBOARD IS OPEN.
- (12) MINIMUM DIMENSION FOR A PROPER AIR FLOW TO THE CONDENSER COIL.
IN THE CASE OF TWO UNITS SIDE BY SIDE THIS DISTANCE MUST BE DOUBLED
- (13) MINIMUM DIMENSION ON THE ELECTRICAL SWITCHBOARD SIDE.
- (14) CLEARANCE ACCESS RECOMMENDED
- (G) BARYCENTRE

SIZE	ST		SC		LN		
	2.340	2.360	2.340	2.360	2.300	2.320	
A	mm	3012	3242	3012	3242	3012	3012
B	mm	2412	2360	2412	2360	2412	2412
C	mm	2188	2010	2188	2010	2188	2188
D	mm	400	457	400	457	400	400
M	mm	3755	3783	3774	3799	3699	3776
N	mm	3857	3829	3838	3813	3913	3836
O	mm	1192	1138	1215	1185	1199	1214
P	mm	1047	1101	1024	1054	1040	1025
OD	mm	168.3	219.1	168.3	219.1	168.3	168.3
Length	mm	7612	7612	7612	7612	7612	7612
Depth	mm	2239	2239	2239	2239	2239	2239
Height	mm	2400	2400	2400	2400	2400	2400
W1	kg	993	955	1066	998	1051	1082
W2	kg	1407	1541	1534	1797	1452	1545
W3	kg	925	924	1020	988	906	1039
W4	kg	873	924	898	888	912	913
W5	kg	1237	1491	1292	1599	1259	1304
W6	kg	813	894	859	879	785	876
Operating weight	kg	6249	6730	6669	7150	6366	6760
Shipping weight	kg	6016	6321	6436	6741	6125	6519

Particular accessories, executions or versions can bring about a great variation of the mass represented here. Please contact our Technical Department.

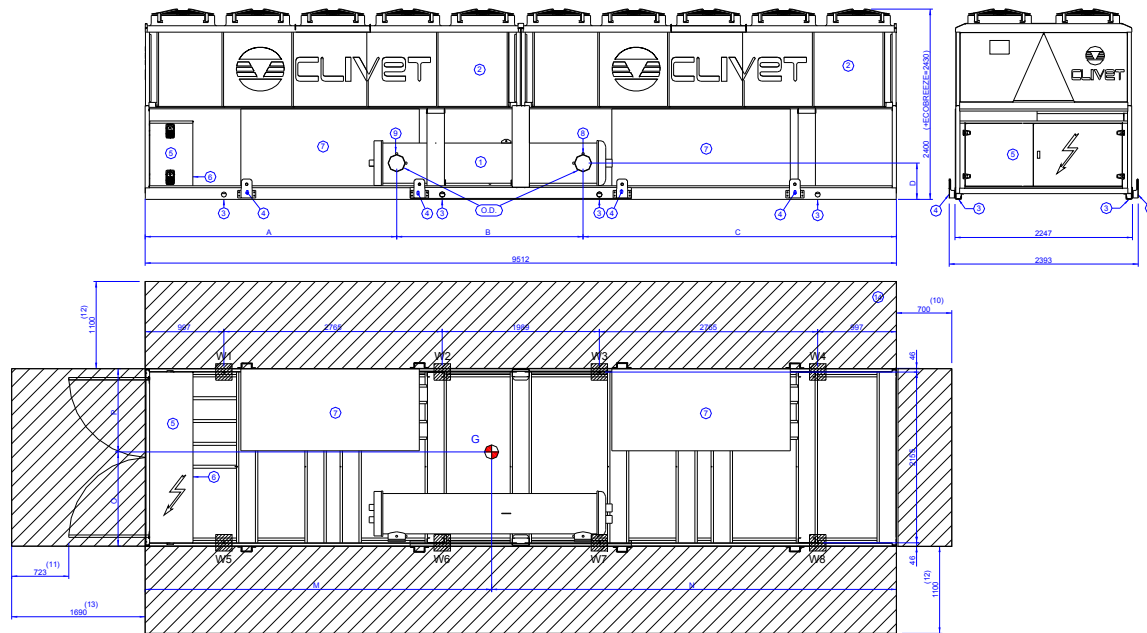

- (1) INTERNAL EXCHANGER (EVAPORATOR)
- (2) EXTERNAL EXCHANGER (CONDENSER)
- (3) HOLE TO HANG UNIT
- (4) LIFTING BRACKETS (REMOVABLE, IF REQUIRED, AFTER POSITIONING THE UNIT)
- (5) ELECTRICAL PANEL
- (6) POWER INPUT
- (7) SOUND PROOF ENCLOSURE (ONLY IN THE EXPECTED VERSIONS)
- (8) INTERNAL EXCHANGER WATER INLET
- (9) INTERNAL EXCHANGER WATER OUTLET
- (10) MINIMUM DIMENSION FOR A SAFE PASSAGE.
- (11) MINIMUM DIMENSION FOR A SAFE PASSAGE WHEN THE DOOR OF THE ELECTRICAL SWITCHBOARD IS OPEN.
- (12) MINIMUM DIMENSION FOR A PROPER AIR FLOW TO THE CONDENSER COIL.
IN THE CASE OF TWO UNITS SIDE BY SIDE THIS DISTANCE MUST BE DOUBLED
- (13) MINIMUM DIMENSION ON THE ELECTRICAL SWITCHBOARD SIDE.
- (14) CLEARANCE ACCESS RECOMMENDED
- (G) BARYCENTRE

SIZE			ST		SC		LN		
			2.440	2.480	2.440	2.480	2.340	2.360	2.440
A	mm		3185	3185	3185	3185	2980	3185	3185
B	mm		2360	2360	2360	2360	2412	2360	2360
C	mm		3967	3967	3967	3967	4120	3967	3967
D	mm		457	457	457	457	400	457	457
M	mm		5061	5027	5050	4989	4850	5021	5010
N	mm		4451	4485	4462	4523	4662	4491	4502
O	mm		1169	1208	1049	1015	1426	1393	1395
P	mm		1078	1039	1198	1432	1021	1054	1052
OD	mm		219.1	219.1	219.1	219.1	168.3	219.1	219.1
Length	mm		9512	9512	9512	9512	9512	9512	9512
Depth	mm		2247	2247	2247	2247	2247	2247	2247
Height	mm		2400	2400	2400	2400	2400	2400	2400
W1	kg		783	948	858	1109	1004	919	975
W2	kg		1302	1475	1390	1690	1324	1497	1554
W3	kg		902	1082	986	1231	1022	1026	1083
W4	kg		848	1005	927	1144	962	966	1021
W5	kg		866	966	899	912	808	816	857
W6	kg		1441	1503	1455	1390	1066	1329	1366
W7	kg		645	733	669	692	605	607	646
W8	kg		607	680	629	643	570	572	610
Operating weight	kg		7394	8392	7814	8812	7362	7731	8112
Shipping weight	kg		6993	8000	7413	8420	7129	7322	7711

Particular accessories, executions or versions can bring about a great variation of the mass represented here. Please contact our Technical Department.

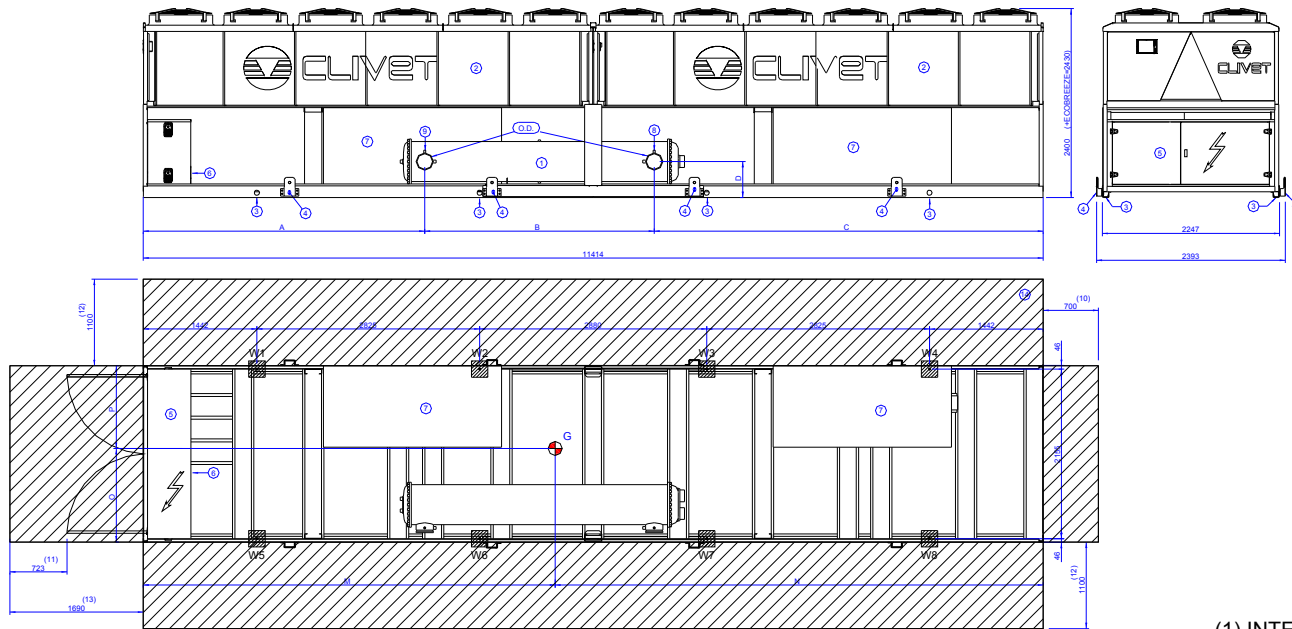

- (1) INTERNAL EXCHANGER (EVAPORATOR)
- (2) EXTERNAL EXCHANGER (CONDENSER)
- (3) HOLE TO HANG UNIT
- (4) LIFTING BRACKETS (REMOVABLE, IF REQUIRED, AFTER POSITIONING THE UNIT)
- (5) ELECTRICAL PANEL
- (6) POWER INPUT
- (7) SOUND PROOF ENCLOSURE (ONLY IN THE EXPECTED VERSIONS)
- (8) INTERNAL EXCHANGER WATER INLET
- (9) INTERNAL EXCHANGER WATER OUTLET
- (10) MINIMUM DIMENSION FOR A SAFE PASSAGE.
- (11) MINIMUM DIMENSION FOR A SAFE PASSAGE WHEN THE DOOR OF THE ELECTRICAL SWITCHBOARD IS OPEN.
- (12) MINIMUM DIMENSION FOR A PROPER AIR FLOW TO THE CONDENSER COIL.
IN THE CASE OF TWO UNITS SIDE BY SIDE THIS DISTANCE MUST BE DOUBLED
- (13) MINIMUM DIMENSION ON THE ELECTRICAL SWITCHBOARD SIDE.
- (14) CLEARANCE ACCESS RECOMMENDED
- (G) BARYCENTRE

SIZE		ST		SC		LN	
		2.540	2.600	2.540	2.600	2.480	2.540
A	mm	3570	3570	3570	3570	4120	3570
B	mm	2910	2910	2910	2910	2360	2910
C	mm	4934	4934	4934	4934	4934	4934
D	mm	457	457	457	457	457	457
M	mm	6030	5921	6015	5943	5744	5937
N	mm	5384	5493	5399	5471	5670	5477
O	mm	1217	1417	1008	1008	1004	1012
P	mm	1030	1030	1439	1439	1443	1435
OD	mm	219.1	219.1	219.1	219.1	219.1	219.1
Length	mm	11414	11414	11414	11414	11414	11414
Depth	mm	2247	2247	2247	2247	2247	2247
Height	mm	2400	2400	2400	2400	2400	2400
W1	kg	1042	1252	1175	1297	1343	1291
W2	kg	1660	1807	1902	1907	1680	1887
W3	kg	1208	1410	1324	1458	1322	1450
W4	kg	1095	1152	1256	1250	1248	1231
W5	kg	1041	1048	953	1047	1058	1048
W6	kg	1658	1513	1543	1539	1324	1532
W7	kg	813	829	741	825	742	826
W8	kg	736	677	702	707	701	702
Operating weight	kg	9253	9687	9595	10029	9418	9967
Shipping weight	kg	8791	9236	9133	9578	9026	9505

Particular accessories, executions or versions can bring about a great variation of the mass represented here. Please contact our Technical Department..

TECHNICAL DATA

Acoustic configuration: Standard (ST) / Compressors insulation (SC)

Size		2.160	2.180	2.190	2.200	2.240	2.280	2.300	2.320	2.340	2.360	2.440	2.480	2.540	2.600	
COOLING																
Cooling capacity	1	kW	400	456	505	556	616	699	767	835	882	935	1016	1138	1272	1411
Compressor power input		kW	112	129	142	159	175	202	224	245	258	274	295	333	369	413
Total power input	2	kW	129	146	162	179	198	225	247	268	284	300	328	366	408	452
Heating capacity total recovery		kW	514	586	637	701	775	872	953	1027	1074	1155	1258	1404	1574	1732
Heating capacity partial recovery		kW	102	117	129	143	158	180	198	216	228	242	262	294	328	365
EER			3.1	3.12	3.12	3.11	3.11	3.11	3.11	3.12	3.11	3.12	3.1	3.11	3.12	3.12
ESEER			3.55	3.45	3.61	3.65	3.64	3.72	3.72	3.79	3.79	3.83	3.67	3.74	3.73	3.77
COMPRESSOR																
Type of compressors	3		DSW	DSW	DSW	DSW	DSW	DSW	DSW	DSW	DSW	DSW	DSW	DSW	DSW	DSW
No. of Compressors		Nr	2	2	2	2	2	2	2	2	2	2	2	2	2	2
Std Capacity control steps		Nr	STEPLESS	STEPLESS	STEPLESS	STEPLESS	STEPLESS	STEPLESS	STEPLESS	STEPLESS	STEPLESS	STEPLESS	STEPLESS	STEPLESS	STEPLESS	STEPLESS
Refrigerant circuits		Nr	2	2	2	2	2	2	2	2	2	2	2	2	2	2
INTERNAL EXCHANGER																
Type of internal exchanger	4		S&T	S&T	S&T	S&T	S&T	S&T	S&T	S&T	S&T	S&T	S&T	S&T	S&T	S&T
No. of internal exchangers		Nr	1	1	1	1	1	1	1	1	1	1	1	1	1	1
Water flow rate (Internal Exchanger)		l/s	19.1	21.8	24.1	26.6	29.4	33.4	36.6	39.9	42.1	44.7	48.5	54.4	60.8	67.4
internal exchanger pressure drop		kPa	59	56	75	76	67	56	73	84	73	76	53	69	83	107
Water content		l	164.4	159.3	152.7	263.3	255.7	248.3	241.2	241.2	233.3	409.6	400.9	391.9	461.8	451.4
EXTERNAL SECTION FANS																
Type of fans	5		AX	AX	AX	AX	AX	AX	AX	AX	AX	AX	AX	AX	AX	AX
Number of fans		Nr	10	10	12	12	14	14	14	14	16	16	20	20	24	24
Standard air flow		l/s	55480	55480	61250	61250	71730	71730	71730	71730	81340	81340	101540	101540	122500	122500
CONNECTIONS																
Water fittings			141.3	141.3	141.3	168.3	168.3	168.3	168.3	168.3	168.3	219.1	219.1	219.1	219.1	219.1
POWER SUPPLY																
Standard power supply		V	400/3/50	400/3/50	400/3/50	400/3/50	400/3/50	400/3/50	400/3/50	400/3/50	400/3/50	400/3/50	400/3/50	400/3/50	400/3/50	400/3/50

(1) data referred to the following conditions :

internal exchanger water = 12/7°C

external exchanger air intake 35°C

(2) According to EUROVENT the Total Power Input does not consider the pump share, required to overcome the pressure drop for the solution circulation inside the exchangers.

(3) DSW = twin-screw compressor

(4) S&T = tube bundle

(5) AX = axial-flow fan

Acoustic configuration: Low noise (LN)

Size		2.160	2.180	2.190	2.200	2.240	2.280	2.300	2.320	2.340	2.360	2.440	2.480	2.540	
COOLING															
Cooling capacity	1	kW	400	454	506	553	614	694	769	829	877	932	1020	1143	1287
Compressor power input		kW	116	131	146	159	180	206	227	247	256	274	304	338	383
Total power input	2	kW	129	146	162	177	198	224	247	267	281	299	329	368	413
Heating capacity total recovery		kW	514	586	637	701	775	872	953	1027	1074	1155	1258	1404	1574
Heating capacity partial recovery		kW	103	117	130	142	159	180	199	215	227	241	265	296	334
EER			3.1	3.11	3.12	3.12	3.1	3.1	3.11	3.1	3.12	3.12	3.1	3.11	3.12
ESEER			3.65	3.64	3.65	3.71	3.74	3.81	3.81	3.85	3.81	3.83	3.85	3.85	3.83
COMPRESSOR															
Type of compressors	3		DSW	DSW	DSW	DSW	DSW	DSW	DSW	DSW	DSW	DSW	DSW	DSW	DSW
No. of Compressors		Nr	2	2	2	2	2	2	2	2	2	2	2	2	2
Std Capacity control steps			STEPLESS	STEPLESS	STEPLESS	STEPLESS	STEPLESS	STEPLESS	STEPLESS	STEPLESS	STEPLESS	STEPLESS	STEPLESS	STEPLESS	STEPLESS
Refrigerant circuits		Nr	2	2	2	2	2	2	2	2	2	2	2	2	2
INTERNAL EXCHANGER															
Type of internal exchanger	4		S&T	S&T	S&T	S&T	S&T	S&T	S&T	S&T	S&T	S&T	S&T	S&T	S&T
No. of internal exchangers		Nr	1	1	1	1	1	1	1	1	1	1	1	1	1
Water flow rate (Internal Exchanger)		l/s	19.1	21.7	24.2	26.4	29.3	33.2	36.7	39.6	41.9	44.5	48.7	54.6	61.5
internal exchanger pressure drop		kPa	59	56	75	75	67	55	73	83	72	75	53	69	85
Water content		l	164.4	159.3	152.7	263.3	255.7	248.3	241.2	241.2	233.3	409.6	400.9	391.9	461.8
EXTERNAL SECTION FANS															
Type of fans	5		AX	AX	AX	AX	AX	AX	AX	AX	AX	AX	AX	AX	AX
Number of fans		Nr	10	12	13	14	14	14	16	16	20	20	20	24	24
Standard air flow		l/s	40520	45060	50500	52790	52790	52790	59180	59180	74630	74630	74630	90130	90130
CONNECTIONS															
Water fittings			141.3	141.3	141.3	168.3	168.3	168.3	168.3	168.3	168.3	219.1	219.1	219.1	219.1
POWER SUPPLY															
Standard power supply		V	400/3/50	400/3/50	400/3/50	400/3/50	400/3/50	400/3/50	400/3/50	400/3/50	400/3/50	400/3/50	400/3/50	400/3/50	400/3/50

(1) data referred to the following conditions :

internal exchanger water = 12/7°C

external exchanger air intake 35°C

(2) According to EUROVENT the Total Power Input does not consider the pump share, required to overcome the pressure drop for the solution circulation inside the exchangers.

(3) DSW = twin-screw compressor

(4) S&T = tube bundle

(5) AX = axial-flow fan

OPERATING LIMITS (COOLING)

Acoustic configuration: Standard (ST) / Compressors insulation (SC)

Size		2.160	2.180	2.190	2.200	2.240	2.280	2.300	2.320	2.340	2.360	2.440	2.480	2.540	2.600
EXTERNAL EXCHANGER															
Max air intake temperature	1	°C	48	47	46	46	46	46	46	46	46	46	46	46	46
Max air intake temperature	2	°C	53	52	51	51	51	51	51	51	51	51	51	51	51
Min. air intake temperature	3	°C	-10	-10	-10	-10	-10	-10	-10	-10	-10	-10	-10	-10	-10
Min. air intake temperature	4	°C	-7	-7	-7	-7	-7	-7	-7	-7	-7	-7	-7	-7	-7
Min. air intake temperature	5	°C	2	2	2	2	2	2	2	2	2	2	2	2	2
Min. air intake temperature	6	°C	11	11	11	11	11	11	11	11	11	11	11	11	11
INTERNAL EXCHANGER															
Max water inlet temperature	7	°C	21	21	21	21	21	21	21	21	21	21	21	21	21
Min. water outlet temperature	8	°C	5	5	5	5	5	5	5	5	5	5	5	5	5
Min. water outlet temperature	9	°C	-8	-8	-8	-8	-8	-8	-8	-8	-8	-8	-8	-8	-8

- (1) unit at full load: internal exchanger water 12/7°C
- (2) capacity-controlled unit (automatic capacity control)
- (3) unit at full load
external exchanger air in quiet
- (4) capacity-controlled unit (automatic capacity control)
external exchanger air in quiet
- (5) capacity-controlled unit (automatic capacity control)
air to external exchanger = 0.5m/sec
- (6) capacity-controlled unit (automatic capacity control)
external exchanger air = 1m/sec
- (7) external exchanger air intake 35°C
- (8) Standard Version
external exchanger air intake 35°C
- (9) Low temperature version
external exchanger air intake 35°C
Fluid with ethylene glycol of 40%

Acoustic configuration: Low noise (LN)

Size		2.160	2.180	2.190	2.200	2.240	2.280	2.300	2.320	2.340	2.360	2.440	2.480	2.540
EXTERNAL EXCHANGER														
Max air intake temperature	1	°C	46	46	46	46	45	45	44	44	44	44	44	44
Max air intake temperature	2	°C	51	51	51	51	50	50	49	49	49	49	49	49
Min. air intake temperature	3	°C	-10	-10	-10	-10	-10	-10	-10	-10	-10	-10	-10	-10
Min. air intake temperature	4	°C	-7	-7	-7	-7	-7	-7	-7	-7	-7	-7	-7	-7
Min. air intake temperature	5	°C	2	2	2	2	2	2	2	2	2	2	2	2
Min. air intake temperature	6	°C	11	11	11	11	11	11	11	11	11	11	11	11
INTERNAL EXCHANGER														
Max water inlet temperature	7	°C	21	21	21	21	21	21	21	21	21	21	21	21
Min. water outlet temperature	8	°C	5	5	5	5	5	5	5	5	5	5	5	5
Min. water outlet temperature	9	°C	-8	-8	-8	-8	-8	-8	-8	-8	-8	-8	-8	-8

- (1) unit at full load: internal exchanger water 12/7°C
- (2) capacity-controlled unit (automatic capacity control)
- (3) unit at full load
external exchanger air in quiet
- (4) capacity-controlled unit (automatic capacity control)
external exchanger air in quiet
- (5) capacity-controlled unit (automatic capacity control)
air to external exchanger = 0.5m/sec
- (6) capacity-controlled unit (automatic capacity control)
external exchanger air = 1m/sec
- (7) external exchanger air intake 35°C
- (8) Standard Version
external exchanger air intake 35°C
- (9) Low temperature version
external exchanger air intake 35°C
Fluid with ethylene glycol of 40%

INTERNAL EXCHANGER PRESSURE DROP

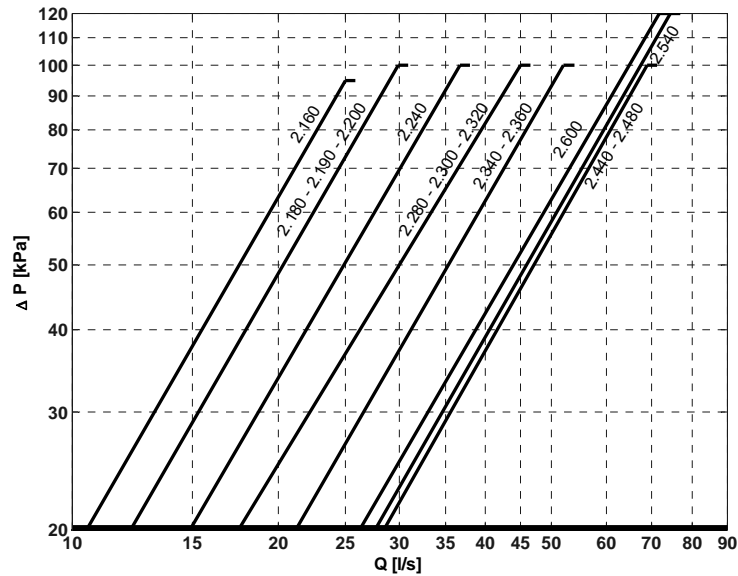

	Qmin [l/s]	Qmax [l/s]
2.160	10.5	25.0
2.180	12.2	29.9
2.190	11.6	28.2
2.200	12.4	31.1
2.240	14.9	36.7
2.280	18.7	46.3
2.300	17.7	43.9
2.320	17.7	43.9
2.340	20.5	50.3
2.360	21.2	52.1
2.440	27.8	70.4
2.480	27.0	67.3
2.540	27.8	74.3
2.600	26.3	71.8

CORRECTION FACTOR FOR ANTIFREEZE SOLUTIONS

% ethylene glycol by weight		5%	10%	15%	20%	25%	30%	35%	40%
Freezing temperature	°C	-2.0	-3.9	-6.5	-8.9	-11.8	-15.6	-19.0	-23.4
Safety temperature	°C	3.0	1.0	-1.0	-4.0	-6.0	-10.0	-14.0	-19.0
Cooling Capacity Factor	Nr	0.995	0.990	0.985	0.981	0.977	0.974	0.971	0.968
Compressor input Factor	Nr	0.997	0.993	0.990	0.988	0.986	0.984	0.982	0.981
Internal exchanger Glycol solution flow Factor	Nr	1.003	1.010	1.020	1.033	1.050	1.072	1.095	1.124
Pressure drop Factor	Nr	1.029	1.060	1.090	1.118	1.149	1.182	1.211	1.243

FOULING CORRECTION FACTOR

m ² °C/W	INTERNAL EXCHANGER	
	F1	FK1
0.44 x 10 ⁻⁴	1.00	1.00
0.88 x 10 ⁻⁴	0.97	0.99
1.76 x 10 ⁻⁴	0.94	0.98

EXCHANGER OPERATING LIMITS

	INTERNAL EXCHANGER	
	DPr (S - B)	
	kPa	
CLIVET (C)	2450	2450
PED (CE)	2450	2450
		DPw
		kPa
		1050
		1050

OVERLOAD AND CONTROL DEVICE CALIBRATION

		OPEN	CLOSED	VALUE
High pressure switch	kPa	1730	1170	-
Low pressure switch	kPa	70.0	170	-
Antifreeze protection	°C	3.00	5.50	-
High pressure safety valve	kPa	-	-	2700
Low pressure safety valve	kPa	-	-	1650
Max no. of compressor starts per hour	Nr	-	-	6.00
High compressor discharge temperature safety thermostat	°C	-	-	120

SOUND LEVELS

Acoustic configuration: Standard (ST)

	Sound Power Level (dB)								dB(A)	dB(A)
	Octave band (Hz)									
	63	125	250	500	1000	2000	4000	8000		
2.160	85	92	93	96	96	94	88	87	80	100
2.180	85	92	93	96	96	94	88	87	80	100
2.190	88	94	95	96	96	94	91	93	81	101
2.200	89	95	96	96	96	94	93	94	81	102
2.240	90	96	96	96	97	95	93	95	81	102
2.280	90	96	96	97	97	94	94	95	81	102
2.300	89	95	95	99	96	96	95	95	82	103
2.320	88	92	93	100	95	97	95	94	82	103
2.340	89	93	94	100	95	98	96	94	82	104
2.360	90	94	94	101	96	98	97	95	83	104
2.440	92	96	97	102	98	100	98	97	84	106
2.480	96	100	105	103	102	99	92	88	84	106
2.540	96	100	106	104	103	100	92	89	85	107
2.600	96	100	106	104	103	100	92	88	85	107

Acoustic configuration: compressors soundproofing (SC)

	Sound Power Level (dB)								Sound pressure level	Sound power level
	Octave band (Hz)									
Size	63	125	250	500	1000	2000	4000	8000	dB(A)	dB(A)
2.160	82	89	90	93	93	92	85	85	77	98
2.180	82	89	90	93	93	92	85	85	77	98
2.190	85	91	92	93	94	92	89	90	78	99
2.200	86	92	93	93	93	91	90	91	78	99
2.240	87	93	93	94	94	92	90	92	79	99
2.280	87	93	93	94	94	91	91	92	79	99
2.300	86	92	92	96	93	93	92	92	79	100
2.320	86	90	90	97	92	94	92	91	79	100
2.340	86	90	91	97	92	95	93	91	79	101
2.360	87	91	92	98	93	95	94	92	80	102
2.440	89	94	95	100	95	97	95	94	81	103
2.480	93	97	102	100	99	96	89	85	81	103
2.540	93	97	103	101	100	98	89	86	82	104
2.600	93	97	103	101	100	97	89	85	82	104

Acoustic configuration: Low noise (LN)

	Sound Power Level (dB)								dB(A)	dB(A)
	Octave band (Hz)									
	63	125	250	500	1000	2000	4000	8000		
2.160	87	90	97	92	89	85	73	67	74	94
2.180	87	90	97	92	89	85	74	67	74	94
2.190	90	94	100	93	90	86	78	75	75	96
2.200	91	94	101	93	89	86	79	77	75	96
2.240	91	94	101	93	90	86	79	77	75	96
2.280	91	95	101	94	90	86	80	78	76	97
2.300	91	94	100	96	90	88	81	78	76	91
2.320	90	92	98	97	88	89	82	77	76	97
2.340	91	93	99	97	89	90	83	78	76	98
2.360	92	94	100	98	90	91	84	79	77	99
2.440	93	95	102	99	91	91	84	79	78	100
2.480	94	96	108	97	92	89	76	68	79	101
2.540	94	96	108	97	92	89	76	67	79	101

Measures according to ISO 3744 regulations, with respect to the EUROVENT 8/1 certification. the sound levels refer to the unit at full load, in the rated test conditions.

The sound pressure level refers to a distance of 1m from the external surface of the units operating in an open field.

data referred to the following conditions :

internal exchanger water = 12/7°C

outdoor air temperature 35°C

CLIVET SPA
Feltre (BL) ITALY
Tel. + 39 0439 3131
Fax + 39 0439 313300
info@clivet.it

CLIVET ESPAÑA S.A.
Madrid - SPAIN
Tel. + 34 91 6658280
Fax + 34 91 6657806
info@clivet.es

CLIVET UK LTD
Fareham (Hampshire) U.K.
Tel. + 44 (0) 1489 572238
Fax + 44 (0) 1489 573033
info@clivet-uk.co.uk

CLIVET NEDERLAND B.V.
Amersfoort - Netherlands
Tel. + 31 (0) 33 7503420
Fax + 31 (0) 33 7503424
info@clivet.nl

CLIVET SPA
BUREAU DE LIAISON EN FRANCE
Verrières le Buisson - FRANCE
Tel. + 33 (0)1 69 20 25 75
Fax + 33 (0)1 69 20 60 76
info.fr@clivet.com

CLIVET GmbH
Norderstedt - GERMANY
Tel. +49 (0) 40 32 59 57-0
Fax +49 (0) 40 32 59 57-194
info.de@clivet.com

CLIVET TFAIR SYSTEMS (P) LTD.
Malur - INDIA
Tel. +91 8151 232683/5
Fax +91-8151-232684
info@clivetta.com

The data contained in this bulletin is not binding and may be changed by the manufacturer without prior notice. All reproduction, even partial, is PROHIBITED.

© COPYRIGHT - CLIVET S.P.A. - FELTRE (BL) - ITALIA